

GTV
LIGHTING





GTV
LIGHTING

GTV Poland to międzynarodowy producent i jedna z czołowych firm na polskim rynku oświetlenia. Oferuje pełną gamę produktów - od źródeł światła po przeznaczone dla konkretnej inwestycji rozwiązania oświetleniowe. Portfolio - jedno z bardziej kompletnych na rynku - obejmuje kilka tysięcy produktów w kilkudziesięciu grupach produktowych. GTV Poland to nowoczesna i profesjonalnie zarządzana firma, a jednocześnie zaufany partner biznesowy dla kontrahentów na całym świecie.

PL

GTV Poland is an international producer and one of the leaders in the Polish lighting market. The Company offers a complete range of products - from light sources to those designed for specific investment lighting solutions. The Portfolio - one of the most extensive in the market - is comprised of thousands of products in several dozen product groups. GTV Poland is a modern company with professional management and, at the same time, a reliable worldwide business partner.

EN

GTV Poland - это международный производитель и одна из ведущих компаний на польском рынке освещения. Компания предлагает полный спектр продуктов - от источников света по предназначенное для конкретной инвестиции комплексное освещение. Портфолио - одно из самых полных на рынке - включает в себя несколько тысяч продуктов, в нескольких десятках группах продукции. GTV Poland - это современная и профессионально управляемая компания, одновременно она является надежным деловым партнером для подрядчиков по всему миру.

RU

GTV Poland ist ein internationaler Vertreter und eines der führenden Unternehmen auf dem polnischen Beleuchtungsmarkt. Es bietet eine vollständige Produktpalette - angefangen von Lichtquellen bis hin zu spezifischen Beleuchtungslösungen für konkrete Investitionsprojekte. Sein Portfolio - eines der vollständigsten auf dem Markt - umfasst mehrere tausend Produkte in Dutzenden von Produktgruppen. GTV Poland ist ein modernes und professionell geführtes Unternehmen und zugleich ein vertrauenswürdiger Geschäftspartner von Vertragspartnern auf der ganzen Welt.

DE

A GTV Poland egy nemzetközi forgalmazó, valamint a lengyel világítástechnikai piac egyik vezető cége. Teljes termékskálát kínál - a fényforrásoktól egészen egy adott befektetésre kifejlesztett világítási megoldásokig. Szakmai portfólió - a piacon az egyik legteljesebb - néhányezer terméket tartalmaz több tíz termékcsoportra bontva. A GTV Poland egy modern és szakszerűen vezetett cég, valamint megbízható üzlettárs a világ minden részéről származó ügyfelek számára.

HU

ŹRÓDŁA ŚWIATŁA
LAMPS
ИСТОЧНИКИ СВЕТА
LEUCHTMITTEL
FENYFORRASOK
18

Źródła Światła LED

Led lamps

Светодиодные источники света

Led-Leuchtmittel

Led fényforrások

21.

Źródła światła tradycyjne

Traditional lamps

Традиционные источники света

Herkömmliche leuchtmittel

Hagyományos fényforrások

46

Świetłówki LED typu T8

T8 led tubes

Светодиодная лампа типа T8

LED-Leuchtröhre vom Typ T8

T8 típusú led fénycső

50

OPRAWY TECHNICZNE I PRZEMYSŁOWE
TECHNICAL AND INDUSTRIAL FIXTURES
ТЕХНИЧЕСКИЕ И ПРОМЫШЛЕННЫЕ СВЕТИЛЬНИКИ
TECHNISCHE UND INDUSTRIELEUCHTEN
MŰSZAKI ÉS IPARI KERETEK
54

Panele i oprawy LED

LED Panels and LED Fixtures

Светодиодные панели

LED-Panele und LED-Leuchten

LED Pannelék és Lámpatestek

57

Oprawy przemysłowe LED

Industrial fixtures

Светодиодные промышленные светильники

Industrieleuchten

Ipari lámpatestek

66

Plafonery i oprawy kanałowe LED

LED Ceiling fixtures & bulkhead fixtures

Светодиодные светильники и светильники ЖКХ

LED Decken- und Feuchtraum-/Außenleuchten

LED Mennyezeti lámpák és mélysugárzó lámpatestek

76

Oprawy LED typu downlight

Downlights

Светильники типа downlight

Downlight

Downlight típusú lámpatestek

94

Naświetlacze LED

Floodlights

Светодиодные прожекторы

Flutlichtstarahler

Fényvetők

110

Oprawy LED typu high bay

High bay LED luminaires

Светодиодные High bay светильники

Highbay led-leuchten

Magas LED-es lámpatestek

114

Oprawy uliczne i parkowe LED

Street and park luminaires LED

Светодиодные уличные и парковые светильники LED

Straßen- und Parkleuchten LED

Utcai és parkos lámpatestek LED

118

Oprawy awaryjne LED

Emergency light fixtures

Аварийные светильники

Notbeleuchtung

Vészvilágítók

122

Oprawy rastrowe, kloszowe

Louvre fittings

Растровые светильники

Rasterleuchten

Vészvilágítók

126

Oprawy przemysłowe

Industrial fixtures

Промышленные светильники

Industrieleuchten

Ipari lámpatestek

134

Plafonery i oprawy kanałowe

Ceiling fixtures & bulkhead fixtures

ЖКХ светильники

Decken- und Feuchtraum-/Außenleuchten

Mennyezeti lámpák és mélysugárzó lámpatestek

142

Oprawy warsztatowe i latarki LED Workshop fixtures & led flashlights Светильники для мастерской и LED-фонари Werkstattleuchten und LED-Taschenlampen Mennyezeti lámpák és mélysugárzó lámpatestek	150.
---	------

**OPRAWY DEKORACYJNE
DECORATIVE FIXTURES
ДЕКОРАТИВНЫЕ СВЕТИЛЬНИКИ
DEKORATIVE FASSUNGEN
DÍSZVILÁGÍTÁS**

154

Oprawy schodowe Staircase fixtures Лестничные светильники Treppenhausleuchten Lépcsővilágítók	157.
---	------

Oprawy punktowe Spot light fixtures Точечные светильники Punktstrahler Spot-keretek	164.
---	------

Oprawy sufitowe Ceiling fixtures Потолочные светильники Deckenleuchten Plafonkeretek	184.
--	------

Oprawy ogrodowe i elewacyjne Garden and wall-mounted fixtures Садовые и фасадные светильники Garten- und Fassadenleuchten Kerti és homlokzati keretek	196.
---	------

Lampki Desk lamps Настольные лампы Schreibtischlampen Asztali lámpák	208.
--	------

**SYSTEMY SZYNOWE
TRACK SYSTEMS
ТРЕКОВЫЕ СИСТЕМЫ ОСВЕЩЕНИЯ
SCHIENENSYSTEME
DÍSZVILÁGÍTÁS**

212

Reflektory LED X-Line Spot lights LED X-Line Светодиодные лампы X-Line Spotlights LED X-Line Raszter, lencsés és modul lámpatestek	215.
--	------

Szynoprzewody Track systems Шинопровод Schienensysteme Plafonkeretek	218.
--	------

**OSPRZĘT ELEKTROINSTALACYJNY
INSTALLATION FITTINGS
ЭЛЕКТРОУСТАНОВОЧНЫЕ ИЗДЕЛИЯ
ELEKTROINSTALLATIONS AUSTRUSTUNG
ELEKTROINSTALLACIOS TERMEKEK**

232

































**OŚWIETLENIE MEBLOWE
FURNITURE LIGHTING
ОСВЕЩЕНИЕ МЕБЕЛИ
MÖBEL BELEUCHTUNG
BÚTOR VILÁGÍTÁS**

266



Źródła światła
Lamps
Источники света
Leuchtmittel
Fenyforrasok

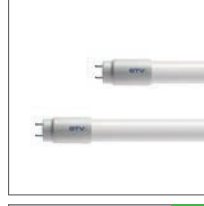
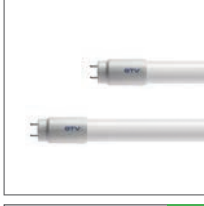





					
LD-SMGC30B 22	LD-SMDC37 22	LD-C35FL4M 22	LD-C35FL4-30 23	LD-SMGC30L 23	LD-SMC37L 23
					
LD-C35FL4M-30L 24	LD-C35FL4-30L 24	LD-SMGB45B-30 24	LD-SMB45B-80 25	LD-G45FL4M 25	LD-G45FL4 25
					
LD-E14S2W0 26	LD-E14P35W 26	LD-R5060W 26	LD-R6380W 27	LD-A60CZ3 27	LD-A60CM3 27
					
LD-PC2A60RGBW 28	LD-3SCTA60 34	LD-3SDA60 28	LD-PC2A60-6W 30	LD-PC3A60-10W 30	LD-PC2A60-12 30
					
LD-PC3A60-15W 31	LD-AL7A60 31	LD-A60FL8M 31	LD-A60FL8 32	LD-G95FL8 32	LD-G125FL8 32
					
LD-ST64FV4 34	LD-G95FV4 34	LD-G125FV4 34	LD-120G14W 35	LD-SMGC30C 35	LD-SMBD45 35

					
LD-SMGB45C 36	LD-UFO18W 36	LD-ALF100 36	LD-ALF140 37	LD-J7806W 37	LD-J11810W 37
					
LD-G93W24 38	LD-G96440 38	LD-G9P35W 38	LD-G9P5W0 39	LD-G9P7W0 39	LD-G93W25 39
					
LD-NGU10PN 40	LD-SZ1510 40	LD-SZ5010 40	LD-PC6010 41	LD-PC7510 41	LD-SM1210 41
					
LD-ES11110 42	LD-ES11100 42	LD-ES11177 42	LD-AR11120 43	LD-G4S15 43	LD-G4P35W 43
					
LD-G4015W 44	LD-SM4016 44	LD-SM6016 44	HL-C90000 47	HL-GU1038 47	HL-J11800 48
					
HL-JCG400 48	SW-NPC09WNB-60 51	SW-NPC09WNB-60D 51	SW-NPC09WNB 52	SW-SZST810W 52	SW-HLSZT809W 53



Oprawy techniczne i przemysłowe
 Technical and industrial fixtures
 Технические и промышленные светильники
 Technische und industrieleuchten
 Műszaki és ipari keretek

LD-GL40060 58	LD-GL40060UGR 58	LD-AKO4060 60	LD-MA45060 60	LD-KNG24063 61	LD-KNG45060 61
LD-PR24063 62	LD-DE40062 62	LD-VE4060W 63	LD-VE2060N 63	LK-PANELX4 64	ZM-PANELSC 64
ZM-PANELSU 64	RM-DE625X625 65	LD-BERGA50W 67	LD-BETISD50W 67	LD-MAG36W0 68	LD-HER50W12 70
LD-OMN060 72	LD-OMN120 72	LD-LUM120 73	LD-OLL20W 73	LD-NPCT809W 74	LD-NPCT836W 74
LD-BES24WOK 77	LD-BES24WKW 77	LD-MOON12W 78	LD-ATL16OK 78	LD-ATL16KW 79	LD-SATU45W 79
LD-EMP22W-40 80	LD-EMP22W-40KW 80	LD-ENZ20W 82	LD-WEND13W 86	LD-WENDM18W 86	LD-WENUSD13 85

					
LD-TOK16WP 84	LD-TOK16WD 84	OS-ITL12W 87	LD-ATO18W 87	LD-LOG16W 88	LD-KALU100K 90
					
LD-KALU100W 90	LD-TWI10WOK 91	LD-TWI10WOW 91	LD-DELOR6W0 92	LD-DELOW6W0 92	LD-DELOR6WC 93
					
LD-DELOW6WC 93	LD-ORN07W 95	LD-ORW03W 95	LD-MAN07W 97	LD-MAW03W 97	LD-MZ12WOK 98
					
LD-MZ12WKW 98	LD-SMBOK09W 99	LD-SMBKW09W 99	LD-BLROK18W 100	LD-BLRKW18W 100	LD-TWN09W 102
					
LD-TWW09W 102	LD-SO206W 104	LD-VEW06W 104	LD-VLROK0538 106	LD-VLRKW0538 106	LD-TOR08W 108
					
LD-FAR10W 108	LD-VIPERS30W 111	LD-INEXT10W 111	LD-INEXT30WP 112	LD-ILUXC10W 112	LD-ILUXC100W 113
					
LD-IMAXC200W 113	LD-HB150W 115	RF-HB150W 115	LD-TK100W 116	SO-TK060DE 116	LD-HBN150W 117



LD-HBM050W 117



LD-PARK30W 119



LD-STEL080W 119



LUR050W 120



SA1 120



LD-SAHER1-DUO 123



OA-SALED1 123

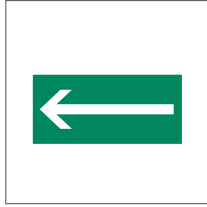

OA-PIKTO 124



OS-LE150NJ 127



OS-RE218N 127



OS-RE418W 128



OS-RC236N 128



OS-SE418W 129



OS-SC236N 129



OS-OSE118 130



OS-OSE218 130



OS-OSL1060S 131



OS-OSL2120S 131



OS-REF136 132



LD-OZE218-00 135



LD-OZE236-01 135



OS-OZE218-00 136



OS-OZE236-01 136



LD-LOTU218 137



LD-HAG136 137



LD-HEL136B 138



OS-HEL118 138



OS-HEK236 139



LD-HEK258 139



LD-LOTB-ME 140



LD-HAG236KL-ME 140



OS-HERZW1 140



OS-PLCRKM 143



OS-PLCZMI 143



OS-PLCRKZ 144



OS-PSL02E27 144



OS-PSLX2E27 145



OS-RINGO1 145



OS-IBBL060 146



OS-IBKR060 146



OS-KACROO 147



OS-KACRKR 147



OS-KAY060 148



OS-KAM060 148



OS-KAN527-24 151



OS-KAN527-24M 151



OS-KAX527 152



OS-KAG508 152



LT-LK3WBL 153



LT-LKSZ3W 153



Oprawy dekoracyjne
Decorative fixtures
Декоративные светильники
Dekorative fassungen
Díszvilágítás



LD-ESOA084 158



LD-ESOB084 158



LD-ESKA084 159



LD-ESKB084 159



LD-OSSLPB1W 160



LD-OSSLPA2W 160



LD-OSSLKD2W 161

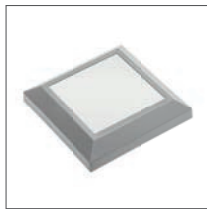

LD-OSSLKW4W 161



LD-OSSLOD2W 162



LD-OSSLOW3W 162



OP-PAST1 165



OP-PAST2 166



OP-PADST1 167



OP-PADRK1 168



OP-PROD3 169



OP-PROD4 170



OP-PRAN5 171



OP-PRAN6 172



OP-VILAKW 173



OP-MAROK 174



OP-OPROKR 174



OP-OPRKWT 175



OP-DUOKWT 175



OP-OPRKW1 176



OP-OPRKW2 176



OP-OPROK1 178



OP-OPROK2 178



OP-PALACEOK 179

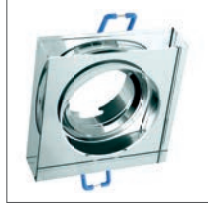

OP-PALACEKW 179



OP-PALACEDOK 180

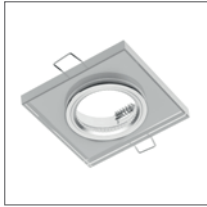

OP-PALACEDKW 180



OP-AUROKB 181

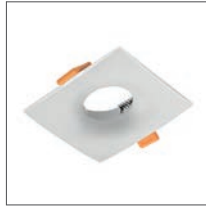

OP-AURKWB 181



OP-SALKW 182



OP-SALOK 182



OS-SENM5081OKCZ 185



OS-SENM5091KWB 185



OS-SEN5087OKCZ 186

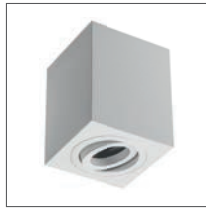

OS-SEN5097KWB 186



OS-SEND5083OKB 188



OP-SENZWOKB 188



OS-BLN50W1 189



OS-BLN50W2 190



OS-BLN50W3 190



OP-PIREN1 192



OP-PIREN2 192

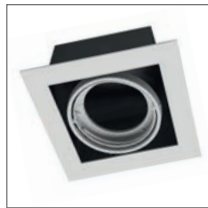

OP-PIREO1 193



OP-PIREO2 193



OP-PIREO3 194



OS-MINIOE27 194



OS-MILA00A 197



OS-MILA10P 197



OS-GRA0DA 198

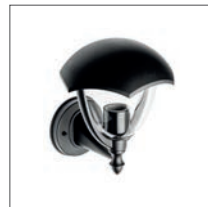

OS-GRA0UA 198



OS-GRA0OP 199



OS-TOS0DA 200



OS-ASTRITE27 200



LD-NESSAGU10J 202



LD-NESSAGU10D 202



LD-SILVAGU10J 203

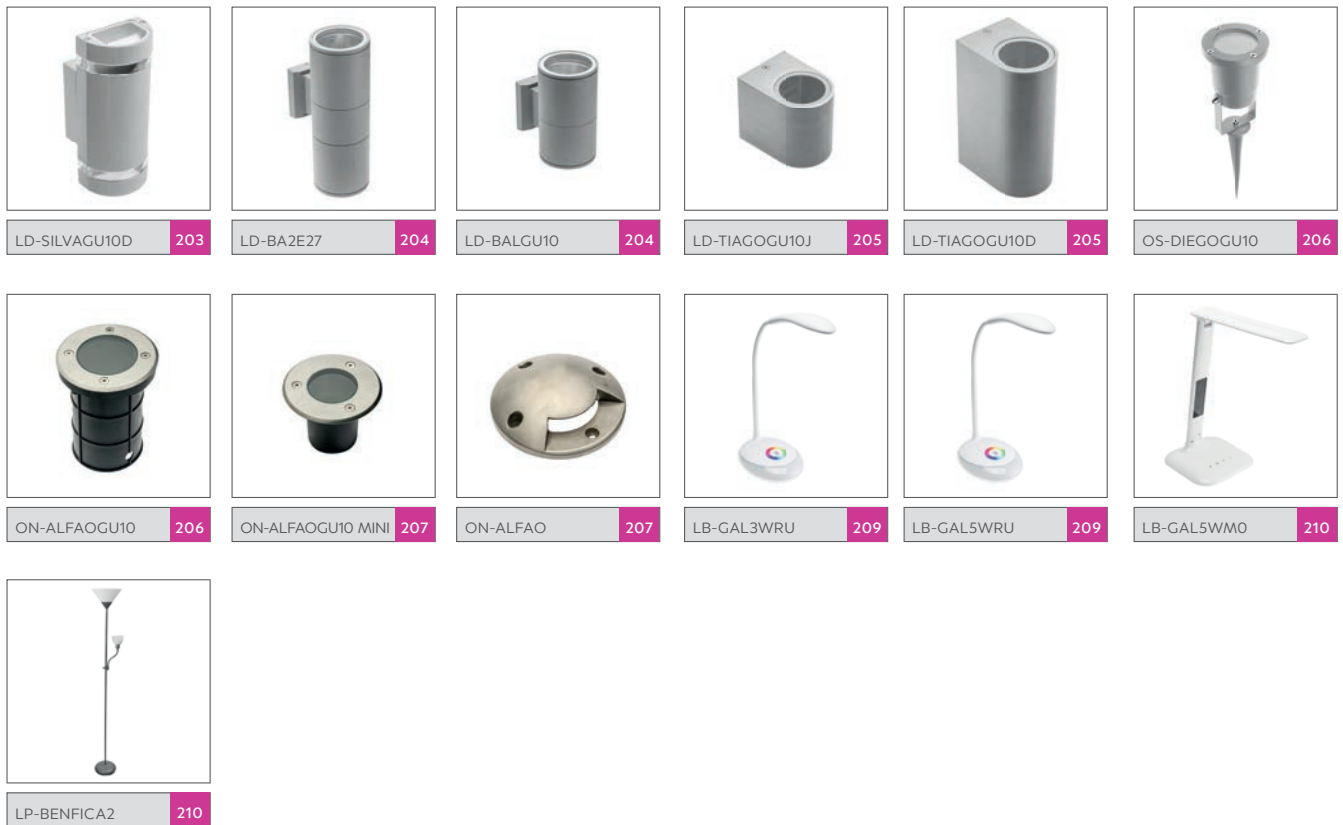

Systemy szynowe
Track systems
Трековые системы освещения
Schienensysteme
Díszvilágítás

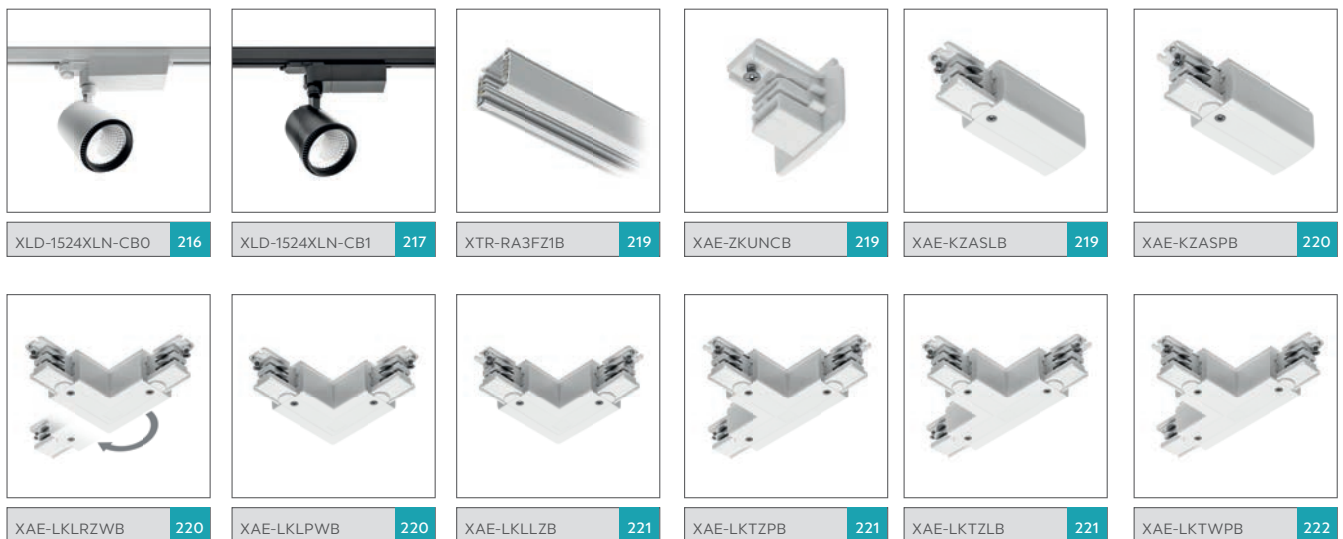



Osprzęt elektroinstalacyjny
Installation fittings
Электроустановочные изделия
Elektroinstallationsausrüstung
Elektroinstallacios termek

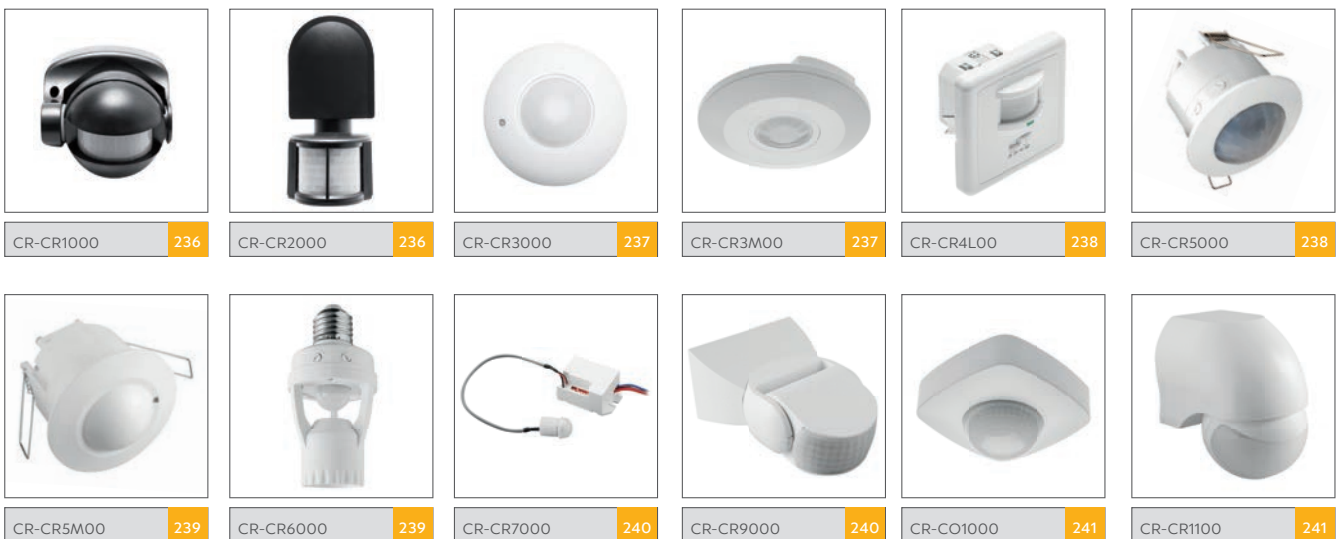

					
CR-CR13000 242	CR-CR15000 242	CR-CR16000 243	AE-CM1000 243	AE-CM3000 244	AE-CM3M00 244
					
AE-CM4000 245	AE-CM5000 245	AE-CM9000 246	AE-CM1500 246	AE-SRC812-MIN 247	AE-SRC812 247
					
CZ-CZ1000 248	CZ-CZ2000 248	PC-MECH24 249	PC-ELE724 249	AE-PS3G3M 250	AE-PF3G1M 250
					
AE-SBEBEN 251	AE-PFBEBEN 251	AE-POGRODUN 252	GZ-GZ10 252	GZ-G90000 253	AE-RU0121 253
					
AE-RU0102 253	AE-SC0102 254	AE-SC0103 254	AE-VA1UNI 254	AE-RU0103 255	AE-OCEF27 255
					
AE-OCEE14 255	AE-OCEE27 256	AE-OCHT27 256	AE-OPE27K 256	AE-OPE27P 257	GZ-E27000 257
					
AE-E14GU10 257	AE-E14E27 258	AE-E27E14 258	AE-27GU10 258	AE-GU10E27 259	AE-E40E27 259



AE-E27RING 259



WZL-2 260



WZL-3 260



WZL-4 260



LZ-KOI2KO 261



LZ-25MM00 261



AE-CANOPY 262



OH-ST2500 262



LD-KABE2M 263



KB-W310HUG 263



OS-STA422 263



OS-SEL118 264



OS-SEL236 264



Oświetlenie meblowe
Furniture lighting
Освещение мебели
Möbel beleuchtung
Bútor világítás



LD-ML1000 270



LD-ML2000 270



LD-ML3000 271



LD-ML4000 271



LD-ML5000 271



LD-3528-300-20 272



LD-3528-300-20-CB 273



LD-3528B-300-20 273



PA-GLAXMICNK 274





















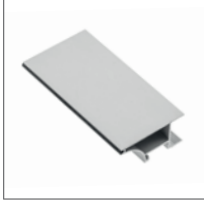





















PA-GLAXMNK 275



PA-GLAXNK 276

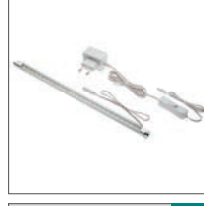

PA-GLAXMNKW 276

					
PA-GLAXMIC 277	PA-GLAX 277	PA-GLAXMW 276	PA-GLAXKT 276	PA-GLAXWPKT 279	PA-GLAXREG1 279
					
PA-GLAXNKKT 280	PA-GLAXRAD 281	PA-GLAXWN 281	PA-GLAXMPK 282	PA-GLAXDR 282	PA-GLAXNB2M16 279
					
PA-GLAXNB2M16 283	PA-GLAXNBD2M16 284	PA-GLAXNBDW2M16 286	PA-GLAXMNB2M16 286	PA-GLAXMNBW2M16 287	PW-PC31209 287
					
LD-VA24CB 288	LD-LU16CB 288	LD-KJVC0B 289	LD-OJVC0B 289	LD-PJVC0B 290	LD-LCG119 290
					
LD-CSN36CB 291	LD-CS36CB 291	LD-ES21ZB 292	LD-VE15CB 292	LD-VE15CBZB 293	LD-IS09CB 293
					
LD-AL24CB 294	LD-TR24CB 294	LD-OPT30S 295	LD-Z50TCB 295	LD-Z3CSCB 296	LD-Z5CSCB 296
					
LD-LCG319 297	LD-OBP27CB 297	LD-KWP27CB 298	LD-LL27CB 298	LD-WL2457 299	LD-OP408C 299



LD-OP456C 300



LD-OPD5W0 300



LD-SR16CB 301



LD-FO120CB 301



LD-RA60CB 302



LD-MAX60CB 302



LD-CO20CB 303



LD-AB18CB 303



LD-EIW09CB 304



LD-NO24CB 304



LD-FL36CB 305



LD-NKW18CB 305



LD-IRUSB 306



LD-CHIC16NE 306



LD-BOS1CBWG 307



LD-KLPCB 307



LD-3SKL 308



OM-OPW000 308



OM-ZH5200 309



LD-ZAS06W 309



LD-ZASPU15W 310



LD-ZSKL15 310



LD-ZWND6W 311



LD-ZZA506KD6 311



LD-WZA20W 312



LD-DIMLED 312



TE-600000 313



LD-KONMINI 313



LD-KONRGB 314



LD-ZAC6WDE 314



LD-ZL5RGB150 315



AE-ZUSB 315



AE-ZLADPOD 316



AE-WBEZDC 317



AE-WBEZDK15 317



AE-WBEZDPIR 318



AE-WBEZDPIR2 318



AE-WBBUNI 319



AE-WDSB 319



AE-WBEZD 320



AE-WPDRW 320



AE-WLPR 321



AE-WLB01 321



AE-WLLAN1 322



AE-WLSZN1 322



AE-WLIP44 322



AE-WLKON 323



LZ-KAPR2M 323



LZ-AKZ312 324



LZ-AKZ612 324



LD-ZTL8MM 325



LD-ZTK8MM 325



LD-ZTK8MM 326



LD-ZTL82M 326



LD-ZTL8MMAMP 327



AE-BPWE3 327



AE-CAP100 328



AE-BPW3U60 328



AE-BPW3GU 329



AE-BPW3GU 329



AE-PB03GS 330



AE-PBU2GU 330



AE-PBKT4U 331



AE-PBMUL6U6U 331



AE-BPW1S2UCH 332



AE-PBC3GS 332



AE-PBC3GS 333



AE-PBC2GS1HDMI 333





ŹRÓDŁA ŚWIATŁA
LAMPS
ИСТОЧНИКИ СВЕТА
LEUCHTMITTEL
FENYFORRASOK



Źródła światła LED	
LED lamps	
Светодиодные источники света	
LED-Leuchtmittel	
LED fényforrások.....	21.
Źródła światła tradycyjne	
Traditional lamps	
Традиционные источники света	
Herkömmliche leuchtmittel	
Hagyományos fényforrások.....	46
Świetlówki LED typu T8	
T8 LED tubes	
Светодиодная лампа типа T8	
LED-Leuchtröhre vom Typ T8	
T8 típusú LED fénycső.....	50



ŹRÓDŁA ŚWIATŁA LED
LED LAMPS
СВЕТОДИОДНЫЕ ИСТОЧНИКИ СВЕТА
LED-LEUCHTMITTEL
LED FÉNYFORRÁSOK



E14

3-6 W



PL Źródło światła LED
 EN LED lamp
 RU Светодиодный источник света
 DE LED-Leuchtmittel
 HU LED diódákkal felszerelt fényforrás

C30

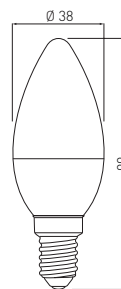

LD-SMGC30B-30	3 W	3 W = 21 W	33 mA	3000 K	200 lm	PF > 0,4	32 g	5901867120014
LD-SMGC30B-60	6 W	6 W = 40 W	52 mA		470 lm	PF > 0,5		5901867171948



PL Źródło światła LED
 EN LED lamp
 RU Светодиодный источник света
 DE LED-Leuchtmittel
 HU LED diódákkal felszerelt fényforrás

C37

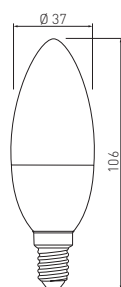

LD-SMDC37-80	8 W	8 W = 54 W	70 mA	3000 K	700 lm	30 g	5902801028373
--------------	-----	------------	-------	--------	--------	------	---------------



PL Źródło światła LED
 EN LED lamp
 RU Светодиодный источник света
 DE LED-Leuchtmittel
 HU LED diódákkal felszerelt fényforrás

C35

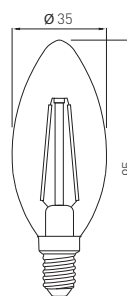

LD-C35FL4M-30	4 W	4 W = 35 W	35 mA	3000 K	400 lm	30 g	5902801232695
---------------	-----	------------	-------	--------	--------	------	---------------



E14

4 W



PL Źródło światła LED
EN LED lamp
RU Светодиодный источник света
DE LED-Leuchtmittel
HU LED diódákkal felszerelt fényforrás

C35

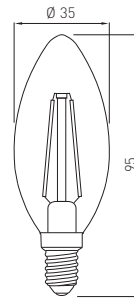

LD-C35FL4-30	4 W	4 W = 35 W	35 mA	3000 K	400 lm	13 g	5901867161512



PL Źródło światła LED
EN LED lamp
RU Светодиодный источник света
DE LED-Leuchtmittel
HU LED diódákkal felszerelt fényforrás

C30

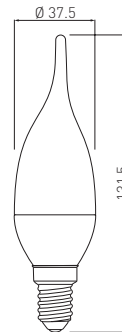

LD-SMGC30L-60	6 W	6 W = 40 W	52 mA	3000 K	470 lm	35 g	5901867120359



PL Źródło światła LED
EN LED lamp
RU Светодиодный источник света
DE LED-Leuchtmittel
HU LED diódákkal felszerelt fényforrás

C37L

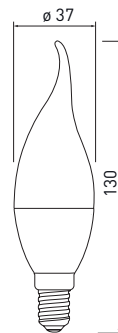

LD-SMC37L-80	8 W	8 W = 50 W	70 mA	3000 K	640 lm	50 g	5902801028380





E14

4 W



PL Źródło światła LED
EN LED lamp
RU Светодиодный источник света
DE LED-Leuchtmittel
HU LED diódákkal felszerelt fényforrás

C35L

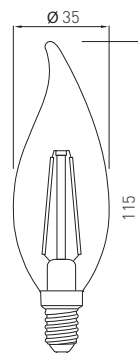

LD-C35FL4M-30L	4 W	4 W = 35 W	35 mA	3000 K	400 lm	30 g	5902801237294
----------------	-----	------------	-------	--------	--------	------	---------------



PL Źródło światła LED
EN LED lamp
RU Светодиодный источник света
DE LED-Leuchtmittel
HU LED diódákkal felszerelt fényforrás

C35L

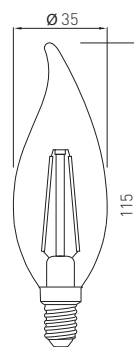

LD-C35FL4-30L	4 W	4 W = 35 W	35 mA	3000 K	400 lm	13 g	5901867161529
---------------	-----	------------	-------	--------	--------	------	---------------



PL Źródło światła LED
EN LED lamp
RU Светодиодный источник света
DE LED-Leuchtmittel
HU LED diódákkal felszerelt fényforrás

B45

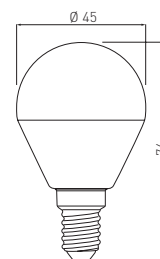

LD-SMGB45B-30	3 W	3 W = 21 W	33 mA	3000 K	200 lm	PF > 0,4	35 g	5901867120410
LD-SMGB45B-60	6 W	6 W = 40 W	52 mA		470 lm	PF > 0,5		5901867120465



E14

3-6 W



PL Źródło światła LED
EN LED lamp
RU Светодиодный источник света
DE LED-Leuchtmittel
HU LED diódákkal felszerelt fényforrás

B45

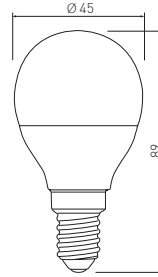

LED
TECHNOLOGY

E14

8 W

Lamps



LD-SMB45B-80	8 W	8 W = 54 W	70 mA	3000 K	700 lm	30 g	5902801028397
--------------	-----	------------	-------	--------	--------	------	---------------



PL Źródło światła LED
EN LED lamp
RU Светодиодный источник света
DE LED-Leuchtmittel
HU LED diódákkal felszerelt fényforrás

G45

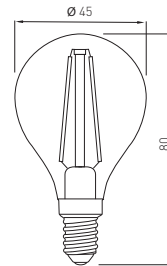

LED
TECHNOLOGY

E14

4 W



LD-G45FL4M-30	4 W	4 W = 35 W	35 mA	3000 K	400 lm	30 g	5902801230172
---------------	-----	------------	-------	--------	--------	------	---------------



PL Źródło światła LED
EN LED lamp
RU Светодиодный источник света
DE LED-Leuchtmittel
HU LED diódákkal felszerelt fényforrás

G45

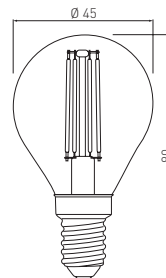

LED
TECHNOLOGY

E14

4 W



LD-G45FL4-30	4 W	4 W = 35 W	35 mA	3000 K	400 lm	13 g	5901867161536
--------------	-----	------------	-------	--------	--------	------	---------------





E14

2 W



PL Źródło światła LED
 EN LED lamp
 RU Светодиодный источник света
 DE LED-Leuchtmittel
 HU LED diódákkal felszerelt fényforrás

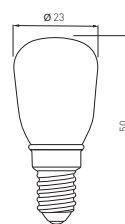

LD-E14S2W0-40	2 W	2 W = 19 W	22 mA	● 4000 K	180 lm	10 g	5901867168719
---------------	-----	------------	-------	----------	--------	------	---------------



E14

3,5 W



PL Źródło światła LED
 EN LED lamp
 RU Светодиодный источник света
 DE LED-Leuchtmittel
 HU LED diódákkal felszerelt fényforrás

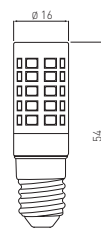

LD-E14P35W-30	3,5 W	3,5 W = 30 W	38 mA	● 3000 K	320 lm	12 g	5901867173621
---------------	-------	--------------	-------	----------	--------	------	---------------



E14

6 W



PL Źródło światła LED
 EN LED lamp
 RU Светодиодный источник света
 DE LED-Leuchtmittel
 HU LED diódákkal felszerelt fényforrás

R50

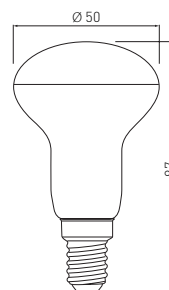

LD-R5060W-30	6 W	6 W = 40 W	52 mA	● 3000 K	470 lm	70 g	5901867113467
--------------	-----	------------	-------	----------	--------	------	---------------



PL Źródło światła LED
EN LED lamp
RU Светодиодный источник света
DE LED-Leuchtmittel
HU LED diódákkal felszerelt fényforrás

R63

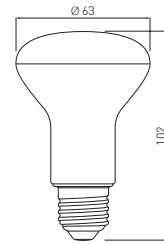

LD-R6380W-30	8 W	8 W = 51 W	70 mA	3000 K	650 lm	130 g	5901867113436



PL Źródło światła LED
EN LED lamp
RU Светодиодный источник света
DE LED-Leuchtmittel
HU LED diódákkal felszerelt fényforrás

A60

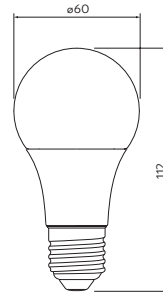

LD-A60CZ3-10W	10 W	10 W = 61 W	87 mA	3000 K	810 lm	40 g	5902801074257
LD-A60CZ4-10W							5902801074233



PL Źródło światła LED
EN LED lamp
RU Светодиодный источник света
DE LED-Leuchtmittel
HU LED diódákkal felszerelt fényforrás

A60

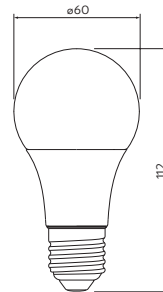

LD-A60CM3-10W	10 W	10 W = 61 W	87 mA	3000 K	810 lm	40 g	5902801073342
LD-A60CM4-10W							5902801073335



PL Źródło światła LED
 EN LED lamp
 RU Светодиодный источник света
 DE LED-Leuchtmittel
 HU LED diódákkal felszerelt fényforrás

A60

LED
TECHNOLOGIES

E27

8 W



RGB



LD-PC2A60RGBW-8W	8 W	8 W = 44 W	70 mA	3000 K & RGB	540 lm	130 g	5901867155290
------------------	-----	------------	-------	--------------	--------	-------	---------------



PL Źródło światła LED
 EN LED lamp
 RU Светодиодный источник света
 DE LED-Leuchtmittel
 HU LED diódákkal felszerelt fényforrás

A60



TRI-COLOR

LED
TECHNOLOGIES

E27

10 W



LD-3SCTA60-10W	10 W	10 W = 62 W	87 mA	3000 K / 4000 K / 6400 K	840 lm	45 g	5902801020131
----------------	------	-------------	-------	--------------------------	--------	------	---------------



PL Źródło światła LED
 EN LED lamp
 RU Светодиодный источник света
 DE LED-Leuchtmittel
 HU LED diódákkal felszerelt fényforrás

A60

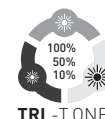
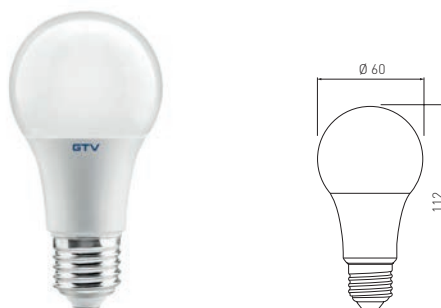

TRI-TONE

LED
TECHNOLOGIES

E27

10 W



LD-3SDA60-10W	10 W	10 W = 62 W	87 mA	3000 K	840 lm	50 g	5902801020148
LD-3SDA606-10W				6400 K			5902801261114



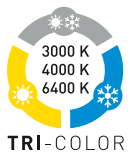

OFF



ON



OFF
<5 sek

ON



OFF
<5 sek

ON



OFF >20 sek



OFF



ON

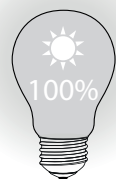

OFF
<5 sek

ON



OFF
<5 sek

ON



OFF >20 sek



PL Źródło światła LED
 EN LED lamp
 RU Светодиодный источник света
 DE LED-Leuchtmittel
 HU LED diódákkal felszerelt fényforrás

A60

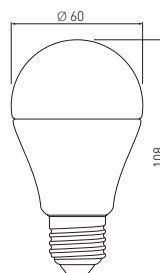

LED

TECHNOLOGY



E27

6 W



LD-PC2A60-6W	6 W	6 W = 40 W	52 mA	3000 K	470 lm	60 g	5901867118745
--------------	-----	------------	-------	--------	--------	------	---------------



PL Źródło światła LED
 EN LED lamp
 RU Светодиодный источник света
 DE LED-Leuchtmittel
 HU LED diódákkal felszerelt fényforrás

A60

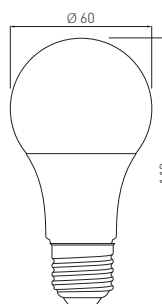

LED

TECHNOLOGY



E27

10 W



LD-PC3A60-10W	10 W	10 W = 62 W	87 mA	3000 K	840 lm	40 g	5901867153302
LD-PN3A60-10W				4000 K			5902801000508
LD-PZ3A60-10W				6400 K			5902801269639



PL Źródło światła LED
 EN LED lamp
 RU Светодиодный источник света
 DE LED-Leuchtmittel
 HU LED diódákkal felszerelt fényforrás

A60

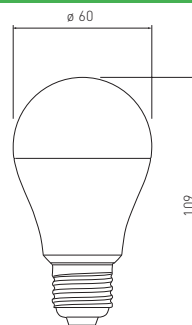

LED

TECHNOLOGY



E27

12 W



LD-PC2A60-12	12 W	12 W = 78 W	104 mA	3000 K	1100 lm	90 g	5901867131621
LD-PN2A60-12				4000 K			5902801000539
LD-PZ2A60-12				6400 K			5902801269646



PL Źródło światła LED
EN LED lamp
RU Светодиодный источник света
DE LED-Leuchtmittel
HU LED diódákkal felszerelt fényforrás

A60

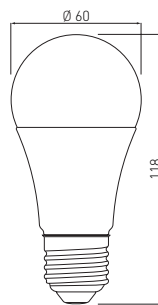

LD-PC3A60-15W	15 W	15 W = 90 W	130 mA	3000 K	1320 lm	140 g	5901867124838
LD-PN3A60-15W				4000 K			5902801000560



PL Źródło światła LED
EN LED lamp
RU Светодиодный источник света
DE LED-Leuchtmittel
HU LED diódákkal felszerelt fényforrás

A60

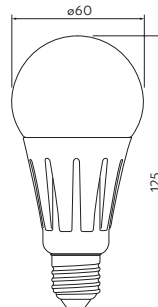

LD-AL7A60-20W	20 W	20 W = 115 W	174 mA	3000 K	1800 lm	157 g	5901867191212



PL Źródło światła LED
EN LED lamp
RU Светодиодный источник света
DE LED-Leuchtmittel
HU LED diódákkal felszerelt fényforrás

A60

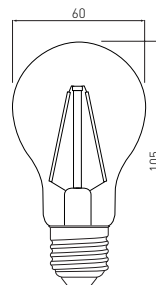

LD-A60FL8M-30	8 W	8 W = 60 W	70 mA	3000 K	800 lm	60 g	5902801232725



PL Źródło światła LED
 EN LED lamp
 RU Светодиодный источник света
 DE LED-Leuchtmittel
 HU LED diódákkal felszerelt fényforrás

A60

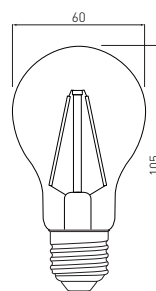

LED

TECHNOLOGIA



E27

8 W



LD-A60FL8-30

8 W

8 W = 60 W

70 mA

3000 K

800 lm

34 g

5901867161505



LED

TECHNOLOGIA



E27

8 W



PL Źródło światła LED
 EN LED lamp
 RU Светодиодный источник света
 DE LED-Leuchtmittel
 HU LED diódákkal felszerelt fényforrás

G95

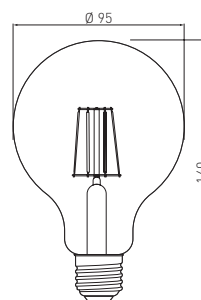

LD-G95FL8-30

8 W

8 W = 60 W

70 mA

3000 K

810 lm

100 g

5901867194466



LED

TECHNOLOGIA



E27

8 W



PL Źródło światła LED
 EN LED lamp
 RU Светодиодный источник света
 DE LED-Leuchtmittel
 HU LED diódákkal felszerelt fényforrás

G125

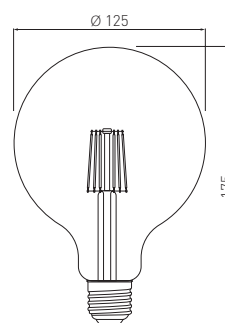

LD-G125FL8-30

8 W

8 W = 60 W

70 mA

3000 K

810 lm

200 g

5901867194473





PL Źródło światła LED
 EN LED lamp
 RU Светодиодный источник света
 DE LED-Leuchtmittel
 HU LED diódákkal felszerelt fényforrás

ST64

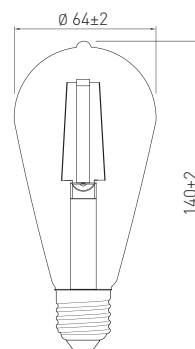

LED

TECHNOLOGY



E27

4 W



LD-ST64FV4-30	4 W	4 W = 36 W	43 mA	3000 K	400 lm	46 g	5902801256608
---------------	-----	------------	-------	--------	--------	------	---------------



PL Źródło światła LED
 EN LED lamp
 RU Светодиодный источник света
 DE LED-Leuchtmittel
 HU LED diódákkal felszerelt fényforrás

G95

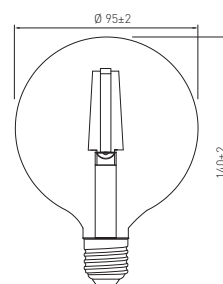

LED

TECHNOLOGY



E27

4 W



LD-G95FV4-30	4 W	4 W = 36 W	43 mA	3000 K	400 lm	56 g	5902801256776
--------------	-----	------------	-------	--------	--------	------	---------------



PL Źródło światła LED
 EN LED lamp
 RU Светодиодный источник света
 DE LED-Leuchtmittel
 HU LED diódákkal felszerelt fényforrás

G125

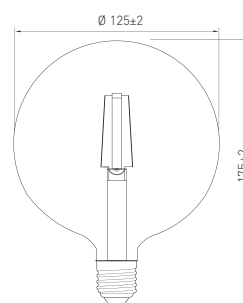

LED

TECHNOLOGY



E27

4 W



LD-G125FV4-30	4 W	4 W = 36 W	43 mA	3000 K	400 lm	100 g	5902801257292
---------------	-----	------------	-------	--------	--------	-------	---------------





E27

14-18 W



PL Źródło światła LED
EN LED lamp
RU Светодиодный источник света
DE LED-Leuchtmittel
HU LED diódákkal felszerelt fényforrás

G120

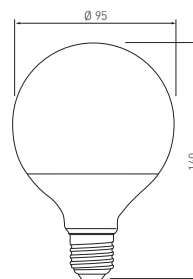

LD-120G14W-32	14 W	14 W = 86 W	122 mA	3000 K	1250 lm	107 g	5901867169242
LD-120G18W-32	18 W	18 W = 105 W	157 mA		1600 lm	155 g	5901867169259



PL Źródło światła LED
EN LED lamp
RU Светодиодный источник света
DE LED-Leuchtmittel
HU LED diódákkal felszerelt fényforrás

C30

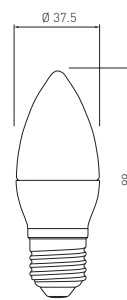

LED
TECHNOLOGY



E27

6 W



LD-SMGC30C-60	6 W	6 W = 40 W	52 mA	3000 K	470 lm	35 g	5901867120175
---------------	-----	------------	-------	--------	--------	------	---------------



PL Źródło światła LED
EN LED lamp
RU Светодиодный источник света
DE LED-Leuchtmittel
HU LED diódákkal felszerelt fényforrás

B45

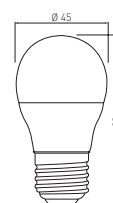

LED
TECHNOLOGY



E27

6 W



LD-SMBD45-80	8 W	8 W = 54 W	70 mA	3000 K	700 lm	30 g	5902801028403
--------------	-----	------------	-------	--------	--------	------	---------------





E27

6 W

PL Źródło światła LED
 EN LED lamp
 RU Светодиодный источник света
 DE LED-Leuchtmittel
 HU LED diódákkal felszerelt fényforrás

B45

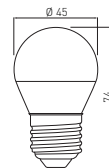

LD-SMGB45C-60	6 W	6 W = 40 W	52 mA	3000 K	470 lm	37 g	5901867120519
---------------	-----	------------	-------	--------	--------	------	---------------



PL Źródło światła LED
 EN LED lamp
 RU Светодиодный источник света
 DE LED-Leuchtmittel
 HU LED diódákkal felszerelt fényforrás

UFO

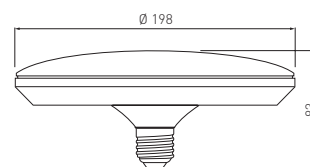

E27

18 W



LD-UFO18W-30	18 W	18 W = 94 W	157 mA	3000 K	1400 lm	240 g	5902801001710
--------------	------	-------------	--------	--------	---------	-------	---------------



PL Źródło światła LED E27, do lamp ulicznych
 EN LED E27 Light Source, for street lamps
 RU Светодиодный источник света E27, для уличных фонарей
 DE LED-Leuchtmittel LED E27 für Strassenlampen
 HU LED E27 Fényforrás, az utcai lámpák

F100, F120

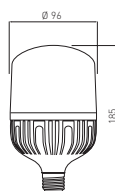

LD-ALF100-30W

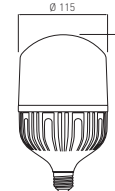

LD-ALF120-40W



E27

30-40 W



LD-ALF100-30W	30 W	145 mA	4000 K	2700 lm	196 g	5901867191199
LD-ALF120-40W	40 W	193 mA		3600 lm	285 g	5901867191205



PL Źródło światła LED E27, do lamp ulicznych
 EN LED E27 Light Source, for street lamps
 RU Светодиодный источник света E27, для уличных фонарей
 DE LED-Leuchtmittel LED E27 für Strassenlampen
 HU LED E27 Fényforrás, az utcai lámpák



50 W

F140

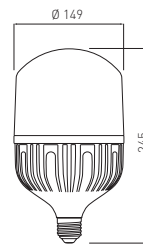

LD-ALF140-50W	50 W	242 mA	● 4000 K	4500 lm	440 g	5902801010736
---------------	------	--------	----------	---------	-------	---------------



PL Źródło światła LED
 EN LED lamp
 RU Светодиодный источник света
 DE LED-Leuchtmittel
 HU LED diódákkal felszerelt fényforrás

J78

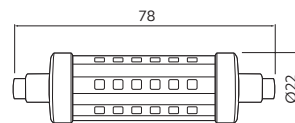

LD-J7806W-40	6 W	6 W = 48 W	52 mA	● 4000 K	600 lm	240 g	5902801007743
--------------	-----	------------	-------	----------	--------	-------	---------------



PL Źródło światła LED
 EN LED lamp
 RU Светодиодный источник света
 DE LED-Leuchtmittel
 HU LED diódákkal felszerelt fényforrás

J118

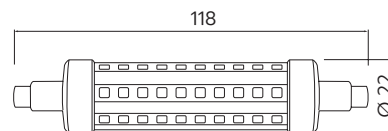

LD-J11810W-40	10 W	10 W = 65 W	87 mA	● 4000 K	900 lm	390 g	5902801007750
---------------	------	-------------	-------	----------	--------	-------	---------------



6 W



10 W





G9

3 W

PL Źródło światła LED
 EN LED lamp
 RU Светодиодный источник света
 DE LED-Leuchtmittel
 HU LED diódákkal felszerelt fényforrás

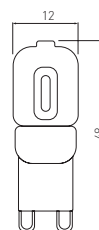

LD-G93W24-32	3 W	3 W = 25 W	33 mA	3000 K	240 lm	40 g	5901867150684
LD-G93W24-45				4000 K			5901867150714



G9

4 W

PL Źródło światła LED
 EN LED lamp
 RU Светодиодный источник света
 DE LED-Leuchtmittel
 HU LED diódákkal felszerelt fényforrás



LD-G96440-32	4 W	4 W = 29 W	43 mA	3000 K	300 lm	20 g	5901867141606
LD-G96440-45				4000 K	320 lm		5901867141620



G9

3,5 W

PL Źródło światła LED
 EN LED lamp
 RU Светодиодный источник света
 DE LED-Leuchtmittel
 HU LED diódákkal felszerelt fényforrás

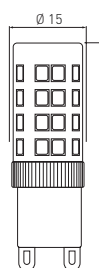

LD-G9P35W-30	3,5 W	3,5 W = 30 W	38 mA	3000 K	320 lm	12 g	5901867168726
LD-G9P35W-40				4000 K			5901867168733





G9

5 W



PL Źródło światła LED
EN LED lamp
RU Светодиодный источник света
DE LED-Leuchtmittel
HU LED diódákkal felszerelt fényforrás



LD-G9P5W0-30	5 W	5 W = 37 W	43 mA	3000 K	420 lm	14 g	5901867168740
LD-G9P5W0-40				4000 K			5901867168757



PL Źródło światła LED
EN LED lamp
RU Светодиодный источник света
DE LED-Leuchtmittel
HU LED diódákkal felszerelt fényforrás

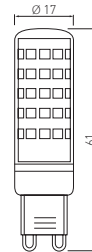

LED
TECHNOLOGY



G9

7 W



LD-G9P7W0-30	7 W	7 W = 45 W	61 mA	3000 K	560 lm	18 g	5902801011344
LD-G9P7W0-40				4000 K			5902801011375



PL Źródło światła LED
EN LED lamp
RU Светодиодный источник света
DE LED-Leuchtmittel
HU LED diódákkal felszerelt fényforrás

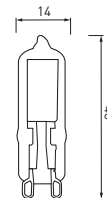

LED
TECHNOLOGY



G9

3 W



LD-G93W25-30	3 W	3 W = 25 W	33 mA	3000 K	250 lm	5 g	5902801211058
LD-G93W25-40				4000 K			5902801203343



PL Źródło światła LED
 EN LED lamp
 RU Светодиодный источник света
 DE LED-Leuchtmittel
 HU LED diódákkal felszerelt fényforrás

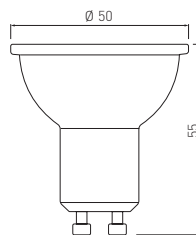

LD-NGU10PN-1W*	1 W	-	14 mA	● 4000 K	100 lm	90°	-	37 g	5901867194954
LD-NGU10P-3W	3 W	3 W = 23 W	33 mA	● 3000 K	220 lm	120°	PF > 0,4	20 g	5901867131591
LD-NGU10P-4W	4 W	4 W = 29 W	43 mA		300 lm				5908231395702



PL Źródło światła LED
 EN LED lamp
 RU Светодиодный источник света
 DE LED-Leuchtmittel
 HU LED diódákkal felszerelt fényforrás

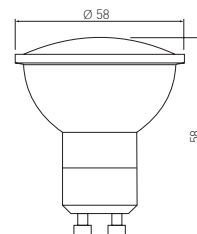

LD-SZ1510-30	4 W	4 W = 30 W	43 mA	● 3000 K	320 lm	45 g	5901867109712
LD-SZ1510-40		4 W = 31 W		● 4000 K	330 lm		5901867109729
LD-SZ1510-64		4 W = 31 W		● 6400 K	340 lm		5901867109743



PL Źródło światła LED
 EN LED lamp
 RU Светодиодный источник света
 DE LED-Leuchtmittel
 HU LED diódákkal felszerelt fényforrás

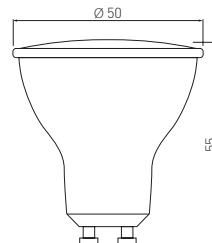

LD-SZ5010-30	5 W	5 W = 36 W	43 mA	● 3000 K	400 lm	45 g	5901867196798
LD-SZ5010-40				● 4000 K			5902801000690
LD-SZ5010-64				● 6400 K			5901867196804



PL Źródło światła LED
EN LED lamp
RU Светодиодный источник света
DE LED-Leuchtmittel
HU LED diódákkal felszerelt fényforrás

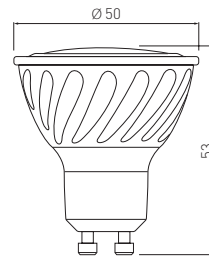

LD-PC6010-30	6 W	6 W = 38 W	52 mA	3000 K	440 lm	52 g	5901867155436
LD-PC6010-40				4000 K			5901867198785
LD-PC6010-64				6400 K			5901867197139



PL Źródło światła LED
EN LED lamp
RU Светодиодный источник света
DE LED-Leuchtmittel
HU LED diódákkal felszerelt fényforrás

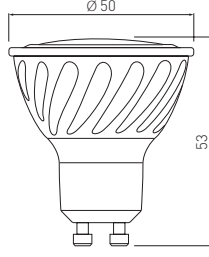

LD-PC7510-30	7,5 W	7,5 W = 46 W	65 mA	3000 K	570 lm	52 g	5901867155405
LD-PC7510-40				4000 K			5901867198792
LD-PC7510-64				6400 K			5901867197160



PL Źródło światła LED
EN LED lamp
RU Светодиодный источник света
DE LED-Leuchtmittel
HU LED diódákkal felszerelt fényforrás

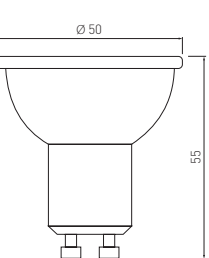

LD-SM1210-10	10 W	10 W = 55 W	87 mA	3000 K	720 lm	50 g	5901867189967
--------------	------	-------------	-------	--------	--------	------	---------------



PL Źródło światła z diodami POWER LED
 EN POWER LED lamp
 RU Источник света со светодиодами POWER LED
 DE LED-Leuchtmittel mit POWER LEDs
 HU POWER LED diódákkal felszerelt fényforrás



LD-ES11110-30



LD-ES11115-30

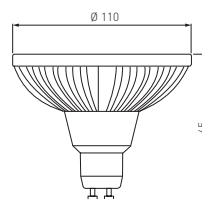

LD-ES11110-30*	12 W	12 W = 69 W	104 mA	3000 K	950 lm	45°	biały, white, белый weiß, fehér	160 g	5901867128157
LD-ES11115-30		12 W = 63 W			850 lm	120°			5901867128171
LD-ES11115-40		12 W = 69 W			4000 K	850 lm			120°



PL Źródło światła z diodami POWER LED
 EN POWER LED lamp
 RU Источник света со светодиодами POWER LED
 DE LED-Leuchtmittel mit POWER LEDs
 HU POWER LED diódákkal felszerelt fényforrás



LD-ES11100-30



LD-ES11101-30

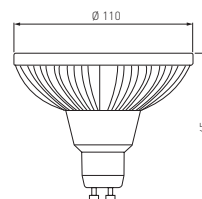

LD-ES11100-30*	12 W	12 W = 69 W	104 mA	3000 K	950 lm	45°	czarny, black, черный, schwarz, fekete	160 g	5901867128119
LD-ES11101-30		12 W = 63 W			850 lm	120°			5901867128113
LD-ES11101-40		12 W = 69 W			4000 K	850 lm			120°



PL Źródło światła z diodami POWER LED
 EN POWER LED lamp
 RU Источник света со светодиодами POWER LED
 DE LED-Leuchtmittel mit POWER LEDs
 HU POWER LED diódákkal felszerelt fényforrás



LD-ES11177-30



LD-ES11175-30

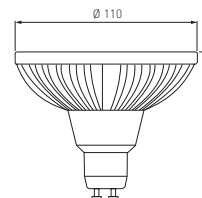

LD-ES11177-30*	12 W	12 W = 69 W	104 mA	3000 K	950 lm	45°	szary, grey, серый, grau, szürke	160 g	5901867127242
LD-ES11175-30		12 W = 63 W			850 lm	120°			5901867127228
LD-ES11175-40					4000 K	850 lm			120°



PL Źródło światła z diodami POWER LED
EN POWER LED lamp
RU Источник света со светодиодами POWER LED
DE LED-Leuchtmittel mit POWER LEDs
HU POWER LED diódákkal felszerelt fényforrás



LD-AR11120-30



LD-AR11145-30

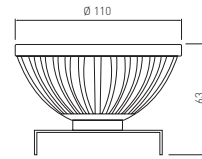

LD-AR11120-30	12 W	12 W = 63 W	3000 K	850 lm	120°	160 g	5901867109446
LD-AR11145-30*		12 W = 69 W		950 lm	45°		5901867109408



PL Źródło światła LED
EN LED lamp
RU Светодиодный источник света
DE LED-Leuchtmittel
HU LED diódákkal felszerelt fényforrás

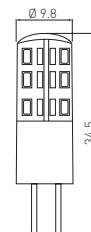

LD-G4S115-32	2 W	2 W = 13 W	3000 K	140 lm	3 g	5901867106322
LD-G4S115-45			4000 K			5901867115966



PL Źródło światła LED
EN LED lamp
RU Светодиодный источник света
DE LED-Leuchtmittel
HU LED diódákkal felszerelt fényforrás

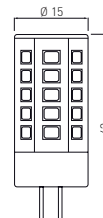

LD-G4P35W-30	3,5 W	3,5 W = 30 W	3000 K	320 lm	11 g	5901867168764
LD-G4P35W-40			4000 K			5901867168771



PL Źródło światła LED
 EN LED lamp
 RU Светодиодный источник света
 DE LED-Leuchtmittel
 HU LED diódákkal felszerelt fényforrás

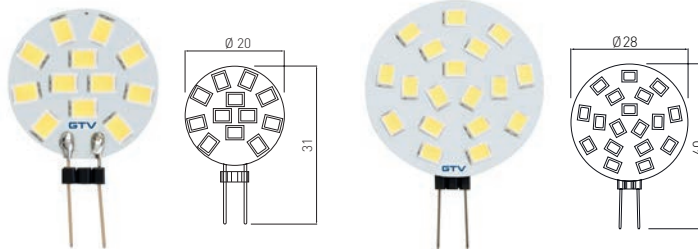

LD-G4015W-30

LD-G4020W-30

LED



G4

1,5-2 W

LD-G4015W-30	1,5 W	1,5 W = 17 W	3000 K	160 lm	1,7 g	5901867191182
LD-G4020W-30	2 W	2 W = 23 W		220 lm	2,9 g	5901867191250



PL Źródło światła LED
 EN LED lamp
 RU Светодиодный источник света
 DE LED-Leuchtmittel
 HU LED diódákkal felszerelt fényforrás



LED



MR16

4 W

LD-SM4016-30	4 W	4 W = 35 W	3000 K	300 lm	30 g	5901867190079
LD-SM4016-64			6400 K			5901867190109



PL Źródło światła LED
 EN LED lamp
 RU Светодиодный источник света
 DE LED-Leuchtmittel
 HU LED diódákkal felszerelt fényforrás



LED



MR16

6 W

LD-SM6016-30	6 W	6 W = 37 W	3000 K	420 lm	30 g	5901867190048



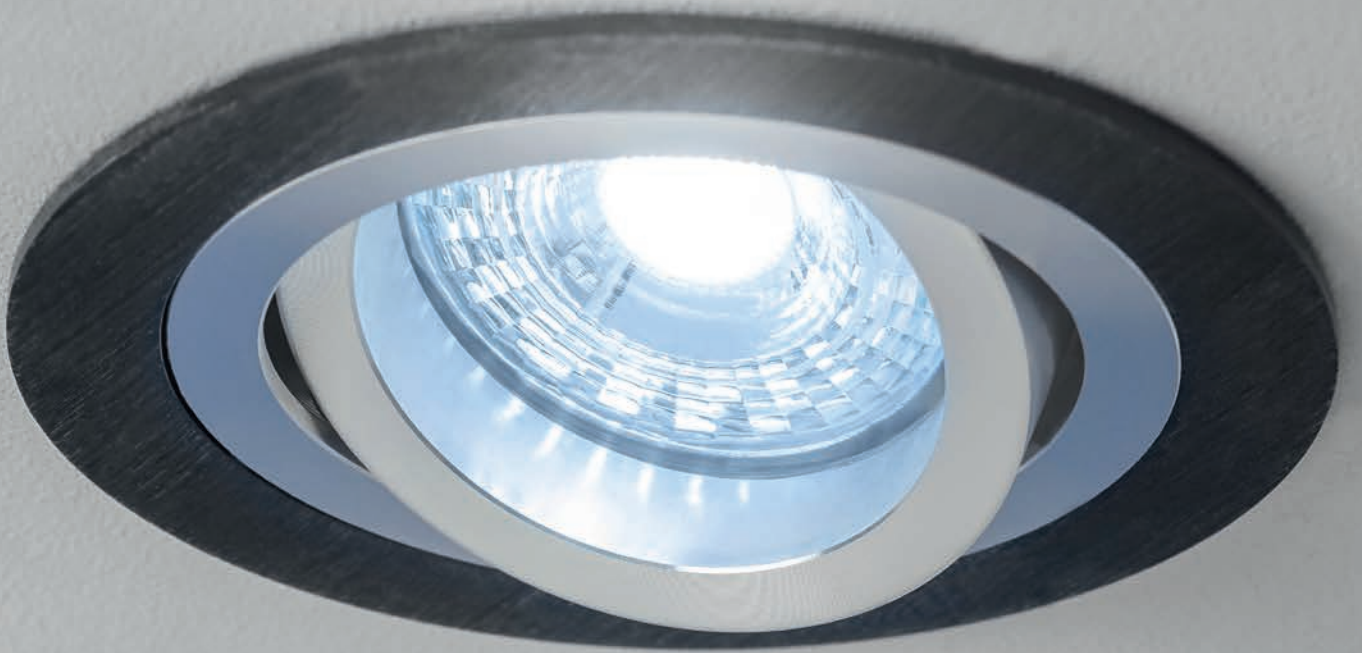



ŹRÓDŁA ŚWIATŁA TRADYCYJNE
TRADITIONAL LAMPS
ТРАДИЦИОННЫЕ ИСТОЧНИКИ СВЕТА
HERKÖMMLICHE LEUCHTMITTEL
HAGYOMÁNYOS FÉNYFORRÁSOK

PL Żarówka halogenowa
EN Halogen lamp
RU Галогенная лампа
DE Halogenleuchtmittel
HU Halogén izzó



20-50 W

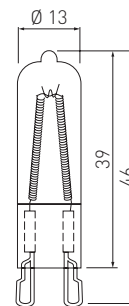

Model	Power (W)	Color Temperature (K)	Lumen (lm)	Weight (g)	Barcode
HL-G90000-20	20 W	● 3000 K	260 lm	3 g	5908231300294
HL-G90000-35	35 W		550 lm		5908231300300
HL-G90000-40	40 W		640 lm		5908231300317
HL-G90000-50	50 W		840 lm		5908231300324



PL Żarówka halogenowa
EN Halogen lamp
RU Галогенная лампа
DE Halogenleuchtmittel
HU Halogén izzó



35 W

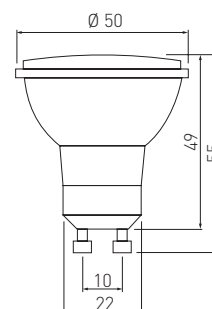

Model	Power (W)	Color Temperature (K)	Lumen (lm)	Weight (g)	Barcode
HL-GU1038-35	35 W	● 3000 K	425 lm	30 g	5908231300140

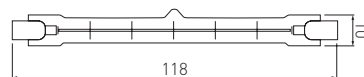

PL Żarówka halogenowa
 EN Halogen lamp
 RU Галогенная лампа
 DE Halogenleuchtmittel
 HU Halogén izzó

R7s
100 W
J118

HL-J11800-10

100 W

3000 K

1810 lm

8 g

5908231300393



PL Żarówka halogenowa
 EN Halogen lamp
 RU Галогенная лампа
 DE Halogenleuchtmittel
 HU Halogén izzó

G4

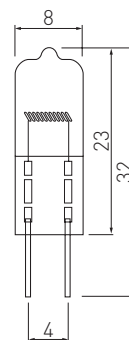
GY 6,35
10-50 W

HL-JCG400-10

10 W

G4

90 lm

5908231300263

HL-JCG400-20

20 W

G4

280 lm

5908231300270

HL-JCG530-35

35 W

GY 6,35

3000 K

550 lm

4 g

5908231302182

HL-JCG530-50

50 W

GY 6,35

900 lm

5908231329066







ŚWIETLÓWKI LED TYPU T8
T8 LED TUBES
СВЕТОДИОДНАЯ ЛАМПА ТИПА Т8
LED-LEUCHTRÖHREN VOM TYP T8
T8 TÍPUSÚ LED FÉNYCSŐ

PL Źródło światła LED, T8
EN LED lamp, T8
RU Светодиодный источник света, T8
DE LED-Leuchtmittel, T8
HU LED diódákkal felszerelt fényforrás, T8

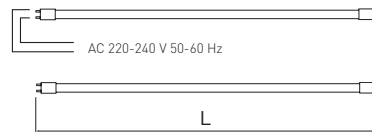

SW-NPC09WNB-60	9 W	78 mA	● 4000 K	700 lm	600 mm	5901867187147
SW-NPC09WZB-60			● 6400 K	700 lm		5901867197498
SW-NPC18WNB-120	18 W	157 mA	● 4000 K	1400 lm	1200 mm	5901867187154
SW-NPC18WZB-120			● 6400 K	1400 lm		5901867197511



PL Źródło światła LED, T8
EN LED lamp, T8
RU Светодиодный источник света, T8
DE LED-Leuchtmittel, T8
HU LED diódákkal felszerelt fényforrás, T8

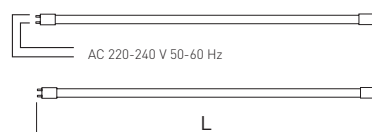

SW-NPC09WNB-60D	9 W	78 mA	● 4000 K	700 lm	600 mm	5902801245206
SW-NPC09WZB-60D			● 6400 K			5902801245176
SW-NPC18WNB-120D	18 W	157 mA	● 4000 K	1400 lm	1200 mm	5902801235672
SW-NPC18WZB-120D			● 6400 K			5902801241567



PL Źródło światła LED, T8
 EN LED lamp, T8
 RU Светодиодный источник света, T8
 DE LED-Leuchtmittel, T8
 HU LED diódákkal felszerelt fényforrás, T8

LED
TECHNOLOGIES

G13

9-18 W



emergency module

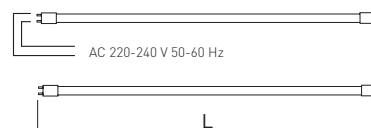

SW-NPC09WNB-60PR	9 W	78 mA	● 4000 K	900 lm	600 mm	5902801006944
SW-NPC18WNB-120PR	18 W	157 mA		1800 lm	1200 mm	5902801006951



PL Źródło światła LED, T8
 EN LED lamp, T8
 RU Светодиодный источник света, T8
 DE LED-Leuchtmittel, T8
 HU LED diódákkal felszerelt fényforrás, T8

LED
TECHNOLOGIES

G13

10-24 W

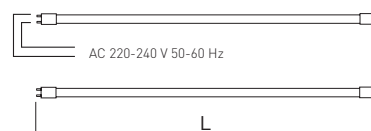





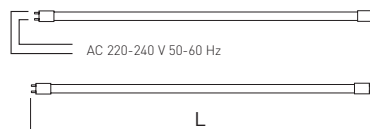

SW-SZST810W-60	10 W	48 mA	● 4000 K	900 lm	600 mm	5902801006807
SW-SZST810W-60			● 6400 K			5902801011603
SW-SZST820W-120	20 W	97 mA	● 4000 K	1800 lm	1200 mm	5902801006821
SW-SZST820W-120			● 6400 K			5902801011627
SW-SZST824W-150	24 W	116 mA	● 4000 K	2200 lm	1500 mm	5902801006845
SW-SZST824W-150			● 6400 K			5902801011641



PL Źródło światła LED, T8
EN LED lamp, T8
RU Светодиодный источник света, T8
DE LED-Leuchtmittel, T8
HU LED diódákkal felszerelt fényforrás, T8



						
SW-HLSZT809W-60	9 W	78 mA	● 4000 K	1050 lm	600 mm	5902801241444
SW-HLSZT818W-120	18 W	157 mA		2150 lm	1200 mm	5902801241451
SW-HLSZT824W-150	24 W	209 mA		2850 lm	1500 mm	5902801241871







OPRAWY TECHNICZNE I PRZEMYSŁOWE
TECHNICAL AND INDUSTRIAL FIXTURES
ТЕХНИЧЕСКИЕ И ПРОМЫШЛЕННЫЕ СВЕТИЛЬНИКИ
TECHNISCHE UND INDUSTRIELEUCHTEN
MŰSZAKI ÉS IPARI KERETEK

Panele i oprawy LED LED Panels and LED Fixtures Светодиодные панели LED-Panele und LED-Leuchten LED Pannellek és Lámpatestek	57
Oprawy przemysłowe LED LED Industrial fixtures Промышленные светильники LED Industrieleuchten LED Ipari lámpatestek	66
Plafoniere i oprawy kanałowe Ceiling fixtures & bulkhead fixtures Светодиодные светильники и светильники ЖКХ Decken- und Feuchtraum-/Außenleuchten Mennyezeti lámpák és mélysugárzó lámpatestek.....	76
Oprawy LED typu downlight Downlights Светильники типа downlight Downlight Downlight típusú lámpatestek.....	94
Naświetlacze LED LED Floodlights Светодиодные прожекторы LED Flutlichtstarahler LED Fényvetők.....	110
Oprawy LED typu high bay High bay LED luminaires Светодиодные High bay светильники Highbay led-leuchten Magas LED-es lámpatestek.....	114
Oprawy uliczne i parkowe LED Street and park luminaires LED Светодиодные уличные и парковые светильники LED Straßen- und Parkleuchten LED Utcai és parkos lámpatestek LED.....	118
Oprawy awaryjne LED Emergency light fixtures Аварийные светильники Notbeleuchtung Vészvilágítók.....	122
Oprawy rastrowe, kloszowe Louvre fittings Аварийные светильники Rasterleuchten Vészvilágítók.....	126
Oprawy przemysłowe Industrial fixtures Промышленные светильники Industrieleuchten Ipari lámpatestek.....	134
Plafoniere i oprawy kanałowe Ceiling fixtures & bulkhead fixtures Плафоны и каналные светильники Decken- und Feuchtraum-/Außenleuchten Mennyezeti lámpák és mélysugárzó lámpatestek.....	142
Oprawy warsztatowe i latarki LED Workshop fixtures & led flashlights светильники для мастерской и LED-фонари Werkstattleuchten und LED-Taschenlampen Mennyezeti lámpák és mélysugárzó lámpatestek	150



PANELE I OPRAWY LED
LED PANELS AND LED FIXTURES
СВЕТОДИОДНЫЕ ПАНЕЛИ
LED-PANELE UND LED-LEUCHTEN
LED PANELLEK ÉS LÁMPATESTEK

PL Panel LED
EN LED Panel
RU Светодиодная панель
DE LED-Paneel
HU LED Panelek

GALAXY

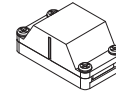

Aksesoria,
Accessories,
Аксессуары,
Zubehör,
Tartozékok:
LZ-KOI2KO-10

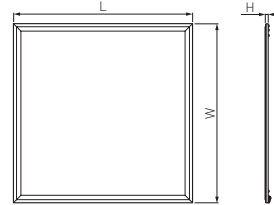

LD-GL40060-NB	40 W	● 4000 K	4400 lm	aluminium aluminium алюминий Aluminium aluminium	595 × 595 × 10	biały, white, белый, weiß, fehér	2700 g	5901867195180
LD-GL40060-NBS					szary, grey, серый, grau, szürke	5901867195166		
LD-GL40120-NB				1195 × 295 × 10	biały, white, белый, weiß, fehér	5901867195357		
LD-GL40120-NBS				szary, grey, серый, grau, szürke	5901867195203			



PL Panel LED
EN LED Panel
RU Светодиодная панель
DE LED-Paneel
HU LED Panelek

GALAXY UGR

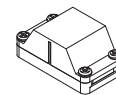

Aksesoria,
Accessories,
Аксессуары,
Zubehör,
Tartozékok:
LZ-KOI2KO-10

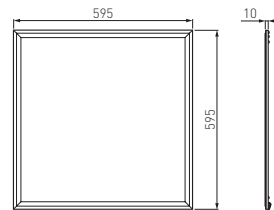

LD-GL40060UGR-NB	40 W	● 4000 K	4400 lm	aluminium aluminium алюминий Aluminium aluminium	595 × 595 × 10	biały, white, белый, weiß, fehér	2700 g	5901867195456
LD-GL40060UGR-NBS					szary, grey, серый, grau, szürke	5901867195470		





PL Ramka LED
EN LED frame
RU Светодиодная рамка
DE LED-Rahmen
HU LED beépítőkeret

AKORDITA

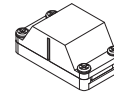
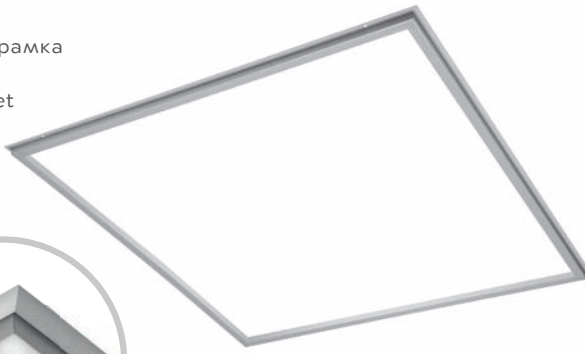

Akcesoria,
Accessories,
Аксессуары,
Zubehör,
Tartozékok:
LZ-KOI2KO-10

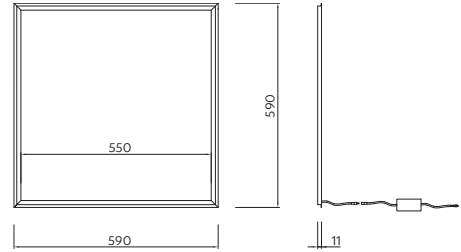

LD-AKO4060-NB	40 W	● 4000 K	3600 lm	aluminium aluminum Алюминий алюминий aluminium	biały, white белый, weiß, fehér	500 g	5902801039966
---------------	------	----------	---------	--	---------------------------------------	-------	---------------



PL Panel LED
EN LED Panel
RU Светодиодная панель
DE LED-Panel
HU LED Panelek

MASTER

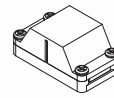

Akcesoria,
Accessories,
Аксессуары,
Zubehör,
Tartozékok:
LZ-KOI2KO-10

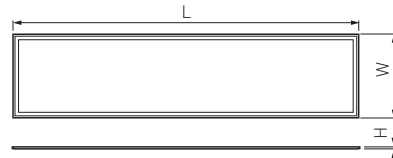

LD-MA45060-NB	50 W	● 4000 K	4000 lm	aluminium aluminium Алюминий алюминий aluminium	595 x 595 x 10	szary, grey, серый, grau, szürke	2600 g	5901867156174
LD-MA45120-NB				aluminium Алюминий aluminium	1195 x 295 x 10	2700 g	5901867156198	



PL Panel LED
EN LED Panel
RU Светодиодная панель
DE LED-Panel
HU LED Panelek

KING

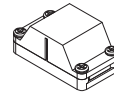

Akcesoria,
Accessories,
Аксессуары,
Zubehör,
Tartozékok:
LZ-KOI2KO-10

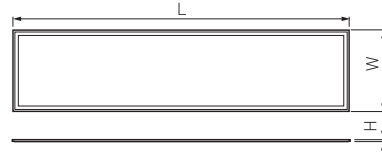

Folder	W	Color	Light	Material	LxWxH mm	Weight	Barcode
LD-KNG24063-NB	24 W	4000 K	1800 lm	aluminium aluminium алюминий Aluminium aluminium	595 × 295 × 10	1500 g	5901867179746
LD-KNG24063-CB		3000 K					5902801261398
LD-KNG42060-NB	42 W	4000 K	3200 lm		595 × 595 × 10	2700 g	5901867168542
LD-KNG42060-CB		3000 K					5902801261343
LD-KNG42312-NB		4000 K			5901867179760		
LD-KNG42312-CB		3000 K			5902801261374		



PL Panel LED
EN LED Panel
RU Светодиодная панель
DE LED-Panel
HU LED Panelek

KING+

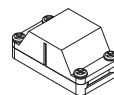

Akcesoria,
Accessories,
Аксессуары,
Zubehör,
Tartozékok:
LZ-KOI2KO-10

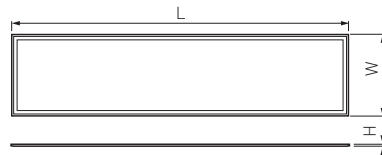

Folder	W	Color	Light	Material	LxWxH mm	Weight	Barcode
LD-KNG45060-NB	45 W	4000 K	4500 lm	aluminium aluminium алюминий Aluminium aluminium	595 × 595 × 10	2780 g	5902801270307
LD-KNG45312-NB					1195 × 295 × 10		2680 g



PL Panel LED
EN LED Panel
RU Светодиодная панель
DE LED-Paneel
HU LED Panelek

PRINCE

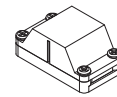

Aksesoria,
Accessories,
Аксессуары,
Zubehör,
Tartozékok:
LZ-KOI2KO-10

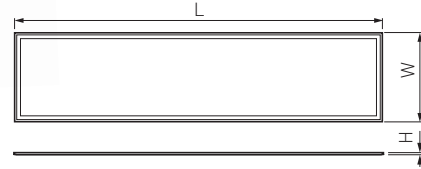

LD-PR24063-NB	24 W	● 4000 K	1900 lm	aluminium aluminium алюминий Aluminium aluminium	595 × 295 × 10	biały, white белый, weiß, fehér	1300 g	5902801010446
LD-PR36060-NB	36 W		2800 lm		595 × 595 × 10		5902801000829	
LD-PR40120-NB	40 W		3200 lm		1195 × 295 × 10		5902801010422	
LD-PR40060-NB	40 W		3200 lm		595 × 595 × 10		5902801000843	
LD-PR45060-NB	45 W		3600 lm		595 × 595 × 10		5902801000867	
LD-PR52120-NB	52 W		4000 lm		1195 × 295 × 10		5902801010439	
LD-PR52060-NB	52 W		4000 lm		595 × 595 × 10		5902801000881	



PL Panel LED
EN LED Panel
RU Светодиодная панель
DE LED-Paneel
HU LED Panelek

ELZA

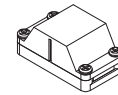

Aksesoria,
Accessories,
Аксессуары,
Zubehör,
Tartozékok:
LZ-KOI2KO-10

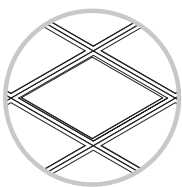

625x625 mm

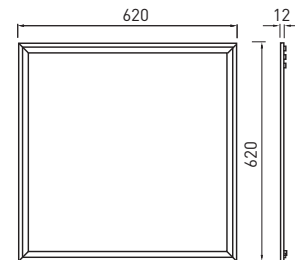

LD-DE40062-NB	40 W	● 4000 K	4400 lm	aluminium aluminium алюминий Aluminium aluminium	biały, white белый, weiß, fehér	3000 g	5902801125379
---------------	------	----------	---------	--	------------------------------------	--------	---------------



PL Oprawa LED
EN LED fixture
RU Светодиодный светильник
DE Leuchte LED
HU LED lámpatest

VERONA

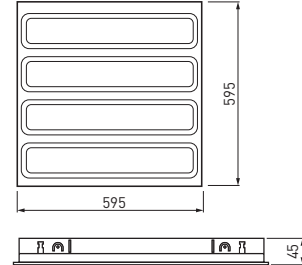

LD-VE4060W-50	50 W	● 4000 K	5500 lm	blacha stalowa steel sheet стальной лист Stahlblech acéllemez	575 x 575 mm	biały, white белый, weiß, fehér	3200 g	5901867106032
---------------	------	----------	---------	---	--------------	---------------------------------------	--------	---------------

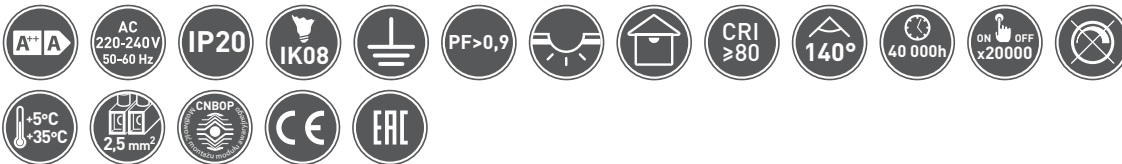

Technical & industrial fixtures

PL Oprawa LED
EN LED fixture
RU Светодиодный светильник
DE Leuchte LED
HU LED lámpatest

VERONA

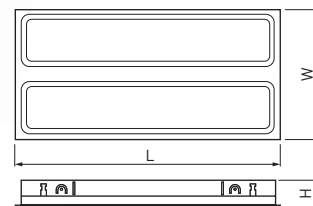

LD-VE2060N-25	25 W	● 4000 K	2750 lm	blacha stalowa steel sheet стальной лист Stahlblech acéllemez	595 × 295 × 35	biały, white белый, weiß, fehér	1100 g	5901867106063
LD-VE2120N-50	50 W		5600 lm		1190 × 295 × 35		2200 g	5901867106094
LD-VE4060N-50			5500 lm		595 × 595 × 37		3200 g	5901867106049



- PL Zestaw linek do podwieszania panela, 1,5 m
 EN Set of cables for a panel suspension bracket 1,5 m
 RU Комплект кабелей для подвески панели 1,5 м
 DE Montageleinen-Satz zum Aufhängen des Paneels 1,5 m
 HU Panelfüggesztő szerelőhuzalok készlete 1,5 m



LK-PANELX4-00	metal	4	5902801270307
---------------	-------	---	---------------

- PL Zestaw do podtynkowego montażu paneli
 EN Set of the built-in mounting panels
 RU Набор встроенного монтажа панелей
 DE Satz für Unterputzmontage des Paneels
 HU Készlet panelek süllyesztett szereléséhez



ZM-PANELSC-00	metal	4	5901867158079
---------------	-------	---	---------------

- PL Zestaw do montażu ściennego
 EN Set for wall fixings
 RU Набор для настенных креплений
 DE Satz für Aufputzmontage
 HU Készlet falra történő szereléshez



ZM-PANELSU-00	metal	4	5901867158055
---------------	-------	---	---------------



- PL Rama do montażu natynkowego paneli
 EN Surface mounted panel frames
 RU Рамка для поверхностного монтажа светильника
 DE Aufputzmontagerahmen für Panele
 HU Falra szerelhető kerett

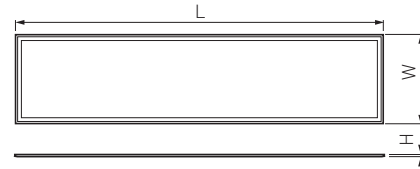

	LxWxH mm			
RM-DE625X625-00	625 x 625 x 43	aluminium aluminium алюминий Aluminium aluminium	biały, white белый, weiß, fehér	5902801073137
RM-KNG60X60-00	600 x 600 x 43			5901867168580
RM-KNG300X600-00	600 x 300 x 43			5901867179753
RM-KNG300X120-00	1200 x 300 x 43		5901867179777	
RM-MA60X60-00	600 x 600 x 43		szary, grey, серый, grau, szürke	5901867157249
RM-MA30X120-00	1200 x 300 x 43			5901867168566



OPRAWY PRZEMYSŁOWE LED
INDUSTRIAL FIXTURES
СВЕТОДИОДНЫЙ ПРОМЫШЛЕННЫЕ СВЕТИЛЬНИКИ
INDUSTRIELEUCHTEN
IPARI LÁMPATESTEK

PL Oprawa LED hermetyczna
EN Hermetic LED fixture
RU Герметический светильник
DE Hermetische Leuchte LED
HU Hermetikus lámpatestek

BERGA

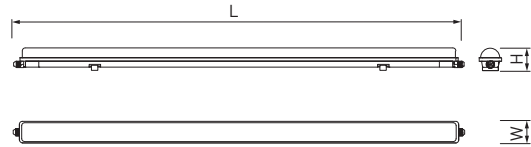

	W	LN				LxWxH mm			
LD-BERGA50W-30	50 W	10		7000 lm	ABS/PC	1190 x 75 x 77	szary, grey, серый, grau, szürke	1360 g	5902801253188
LD-BERGA70W-30	70 W	7	● 4000 K	9800 lm		1570 x 75 x 77			1740 g

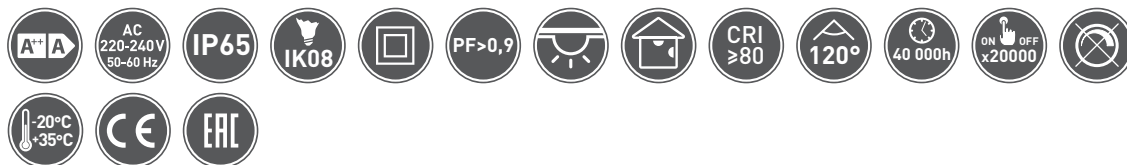

PL Oprawa LED hermetyczna
EN Hermetic LED fixture
RU Герметический светильник
DE Hermetische Leuchte LED
HU Hermetikus lámpatestek

BETIS

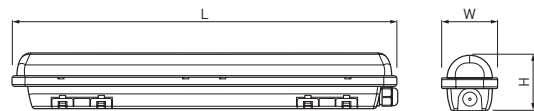

	W	LN				LxWxH mm			
LD-BETISD50W-30	50 W	22		6000 lm	PC	1200 x 75 x 95	biały, white белый, weiß, fehér	680 g	5902801015670
LD-BETISD70W-30	70 W	15	● 4000 K	8400 lm		1500 x 75 x 95			1350 g

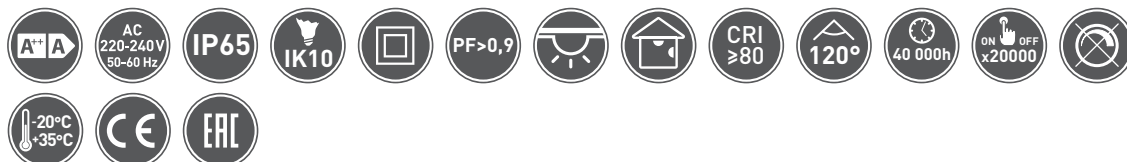

PL Linia szybkiego montażu
EN Quick assembly line
RU Линия быстрого монтажа
DE Schnellmontagelinie
HU Gyors rögzítő vonal

MAGNAT

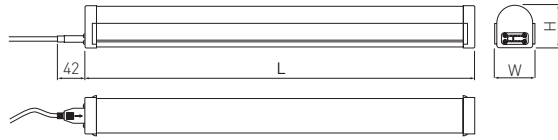

36-45 W



Technical & industrial
fixtures



LD-MAG36W0-40	36 W	20	● 4000 K	4300 lm	PC	1200 × 62 × 66	biały, white белый, weiß, fehér	400 g	5902801017490
LD-MAG45W0-40	45 W	15		5400 lm		1500 × 62 × 66		700 g	5902801017506



PL Akcesoria
EN Accessories
RU Аксессуары
DE Zubehör
HU Tartozékok



ZM-MAG1PKB-10



ZM-MAG2PKB-10



ZM-MAG2PZL-10



ZM-MAGZSLM-10



LD-MAGCMS-10



ZM-MAG1PKB-10	-	5902801017513
ZM-MAG2PKB-10	-	5902801017520
ZM-MAG2PZL-10	-	5902801017537
ZM-MAGZSLM-10	-	5902801017544
LD-MAGCMS-10	max 320 W	5902801017551

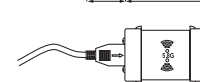
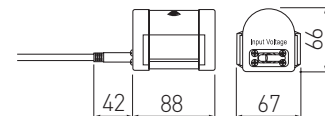

LD-MAGCMS-10



PL Oprawa LED hermetyczna
 EN Hermetic LED fixture
 RU Герметический светильник
 DE Hermetische Leuchte LED
 HU Hermetikus lámpatestek

HEROS



Technical & industrial
fixtures



LD-HER50W12-NB	50 W	20	● 4000 K	6000 lm	aluminium, szkło hartowane aluminium, tempered glass алюминий, закаленное стекло Aluminium, Gehartetes Glas aluminium, hőkezelt üveg	biały, white белый, weiß, fehér	4200 g	5902801219559

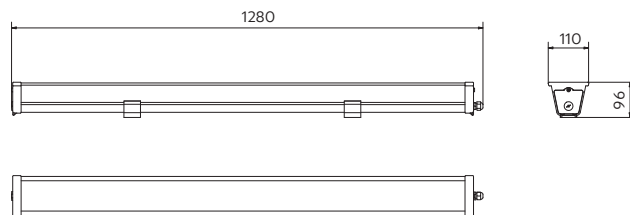



PL Oprawa LED hermetyczna
EN Hermetic LED fixture
RU Герметический светильник
DE Hermetische Leuchte LED
HU Hermetikus lámpatestek



OMNIA BIS

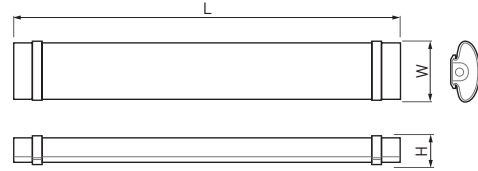
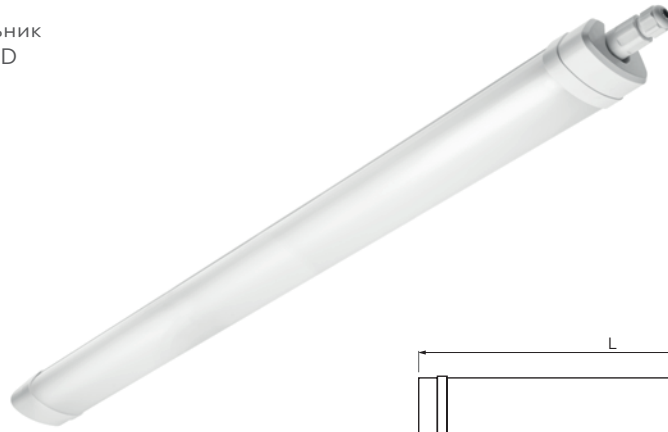

Technical & industrial fixtures

Folder	W	Color	Light	Material	LxWxH mm	Color	Weight	Barcode
LD-OMN060-30B	30 W	● 4000 K	3000 lm	PC	640 × 50 × 85	biały, white белый, weiß, fehér	400 g	5902801038587
LD-OMN120-60B	60 W		6000 lm		1240 × 50 × 85		670 g	5902801038693
LD-OMN150-70B	70 W		7000 lm		1540 × 50 × 85		750 g	5902801038686



PL Oprawa LED hermetyczna
EN Hermetic LED fixture
RU Герметический светильник
DE Hermetische Leuchte LED
HU Hermetikus lámpatestek

OMNIA MAX

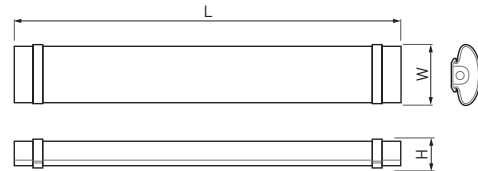

Folder	W	LN	Color	Light	Material	LxWxH mm	Color	Weight	Barcode
LD-OMN120-75M	75 W	10	● 4000 K	7500 lm	PC	1242 × 118 × 56	biała, white, белый, weiß, fehér	1250 g	5902801025846
LD-OMN150-90M	90 W	9		9000 lm		1542 × 118 × 56		1500 g	5902801025853



PL Oprawa LED hermetyczna
EN Hermetic LED fixture
RU Герметический светильник
DE Hermetische Leuchte LED
HU Hermetikus lámpatestek

LUMIA

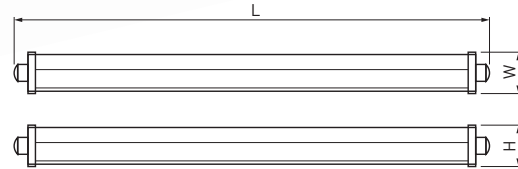
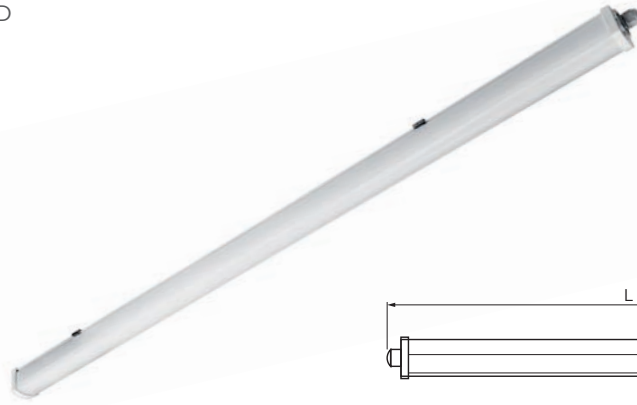

Folder	W	LN	Color	Light	Material	LxWxH mm	Color	Weight	Barcode
LD-LUM120-30P	36 W	10	● 4000 K	3600 lm	PC	1205 × 49 × 56	biały, white белый, weiß, fehér	670 g	5901867155733
LD-LUM150-30P	45 W	8		4500 lm		1512 × 49 × 56		680 g	5901867155757

PL Oprawa LED natynkowa
EN Surface mounted LED fixture
RU Светодиодный накладной светильник
DE Aufputz-LED-Leuchte
HU Süllyesztett LED lámpatest

ASPEN

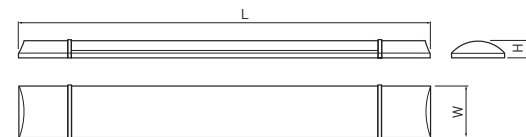
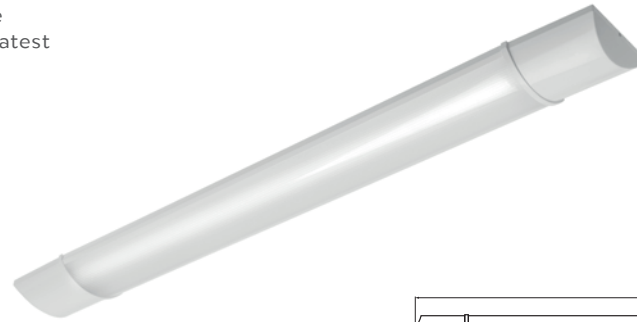

Folder	W	Color	Light	Material	LxWxH mm	Color	PF	Weight	Barcode
LD-OLL20W-NB	20 W	● 4000 K	1800 lm	PC	600 × 68 × 23	biały, white белый, weiß, fehér	PF > 0,5	190 g	5902801010453
LD-OLL40W-NB	40 W		3600 lm		1200 × 68 × 23		PF > 0,9	360 g	5902801010460
LD-OLL50W-NB	50 W		4500 lm		1500 × 68 × 23		475 g	5902801010477	

Technical & industrial fixtures

PL Oprawa LED natynkowa
EN Surface mounted LED fixture
RU Светодиодный накладной светильник
DE Aufputz-LED-Leuchte
HU Süllyesztett LED lámpatest

VELA

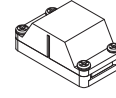
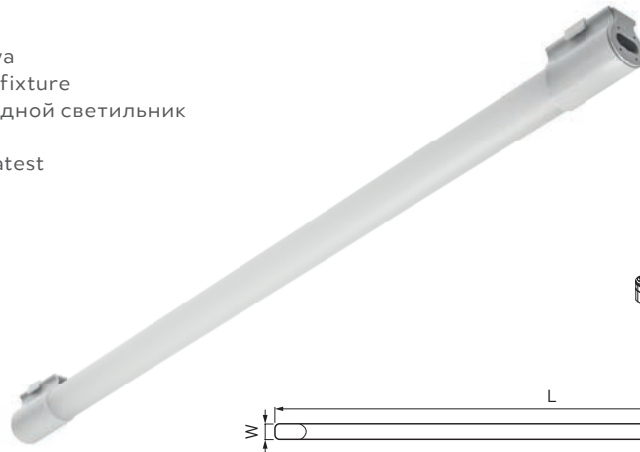

Akcesoria,
Accessories,
Аксессуары,
Zubehör,
Tartozékok:
LZ-KOI2KO-10

LED
LIGHTING

inside

9-18 W

through-Line
MAX 4 A

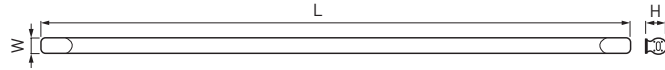

Folder	W	LN	Color	Beam	Material	LxWxH mm	Weight	Barcode
LD-NPCT809W-40	9 W	5	● 4000 K	700 lm	PC	600 × 28 × 35	87 g	5902801017568
LD-NPCT818W-40	18 W			1400 lm		1200 × 28 × 35	143 g	5902801017575
LD-NPCT818W-RD	18 W		●	-		1200 × 28 × 35	143 g	5902801229534
LD-NPCT818W-GR			●	-		1200 × 28 × 35	143 g	5902801229473
LD-NPCT818W-BL			●	-		1200 × 28 × 35	143 g	5902801230776

PL Oprawa LED natynkowa
EN Surface mounted LED fixture
RU Светодиодный накладной светильник
DE Aufputz-LED-Leuchte
HU Süllyesztett LED lámpatest

VELA

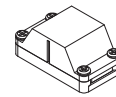

Akcesoria,
Accessories,
Аксессуары,
Zubehör,
Tartozékok:
LZ-KOI2KO-10

LED
LIGHTING

inside

36 W

through-Line
MAX 4 A

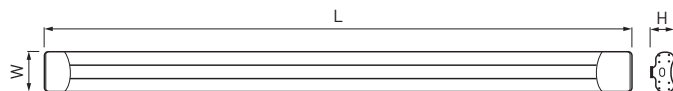

Folder	W	LN	Color	Beam	Material	LxWxH mm	Weight	Barcode
LD-NPCT836W-40	36 W	5	● 4000 K	2800 lm	PC	1200 × 77 × 35	284 g	5902801017582





PLAFONIERY I OPRAWY KANAŁOWE LED
LED CEILING FIXTURES & BULKHEAD FIXTURES
СВЕТОДИОДНЫЕ СВЕТИЛЬНИКИ И СВЕТИЛЬНИКИ ЖКХ
LED DECKEN- UND FEUCHTRAUM-/AUSSENLEUCHTEN
LED MENNYEZETI LÁMPÁK ÉS MÉLYSUGÁRZÓ LÁMPATESTEK

PL Plafoniera LED
EN LED ceiling light fitting
RU Светодиодный светильник
DE LED-Deckenleuchte
HU LED-es mennyezeti lámpa

BESA

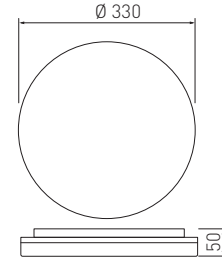

LD-BES24WOK-40	24 W	● 4000 K	2400 lm	PC	biała, white, белый, weiß, fehé	880 g	5902801041532



PL Plafoniera LED
EN LED ceiling light fitting
RU Светодиодный светильник
DE LED-Deckenleuchte
HU LED-es mennyezeti lámpa

BESA

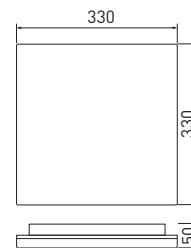

LD-BES24WKW-40	24 W	● 4000 K	2400 lm	PC	biała, white, белый, weiß, fehé	880 g	5902801041891



PL Plafoniera LED
EN LED ceiling light fitting
RU Светодиодный светильник
DE LED-Deckenleuchte
HU LED-es mennyezeti lámpa

MOON

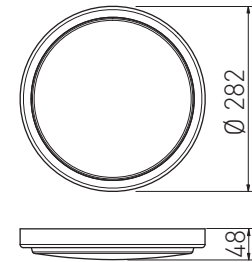

Technical & industrial
fixtures

LD-MOON12W-NB	12 W	● 4000 K	1200 lm	PC/PC	biała, white, белый, weiß, fehér	630 g	5902801219443
LD-MOON18W-NB	18 W		1800 lm				5902801219498



PL Plafoniera LED
EN LED ceiling light fitting
RU Светодиодный светильник
DE LED-Deckenleuchte
HU LED-es mennyezeti lámpa

ATLANTIS

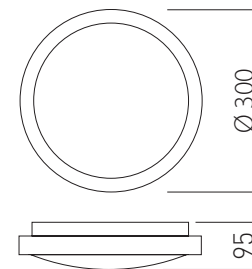

LD-ATL160K-40	16 W	● 4000 K	960 lm	akryl, aluminium acrylic, aluminium акрил, алюминий Acryl, Aluminium akril, aluminium	biały, white белый, weiß, fehér	628 g	5901867190505



PL Oprawa LED hermetyczna
EN Hermetic LED fixture
RU Светодиодный светильник
DE Hermetische Leuchte LED
HU Hermetikus lámpatestek

ATLANTOS

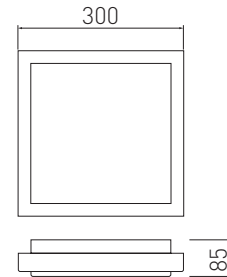

LD-ATL16KW-40	16 W	● 4000 K	960 lm	akryl, aluminium acrylic, aluminium акрил, алюминий Acryl, Aluminium akril, aluminium	biała, white, белый, weiß, fehé	960 g	5901867190567



PL Plafoniera LED
EN LED ceiling light fitting
RU Светодиодный потолочный светильник
DE LED-Deckenleuchte
HU LED mennyezeti lámpa

SATURN

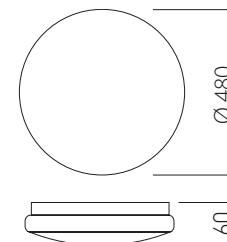

LD-SATU45W-NB	45 W	● 4000 K	3600 lm	akryl, acrylic, акрил, Acryl, akril,	biały, white белый, weiß, fehér	1400 g	5902801270635



Technical & industrial
fixtures



PL Plafoniera LED
 EN LED ceiling light fitting
 RU Светильник потолочный
 DE LED-Deckenleuchte
 HU LED-es mennyezeti lámpa

EMPOLIO

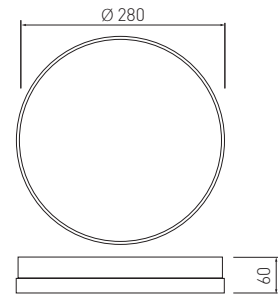

Technical & industrial
fixtures



LD-EMP22W-40	22 W	● 4000 K	1800 lm	PC/PC	biała, white, белый, weiß, fehé	743 g	5902801011276



PL Plafoniera LED
 EN LED ceiling light fitting
 RU Светильник потолочный
 DE LED-Deckenleuchte
 HU LED-es mennyezeti lámpa

EMPOLIO

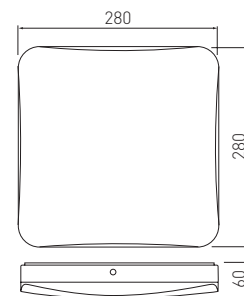

LD-EMP22W-40KW	22 W	● 4000 K	1800 lm	PC/PC	biała, white, белый, weiß, fehé	753 g	5902801027208



24

PL Plafoniera LED
 EN LED ceiling light fitting
 RU Светильник потолочный
 DE LED-Deckenleuchte
 HU LED-es mennyezeti lámpa

ENZO

Technical & industrial
fixtures



LD-ENZ20W-40	20 W	● 4000 K	1500 lm	akryl, acrylic, акрил, Acryl, akril	biała, white, белый, weiß, fehé	885 g	5901867198297

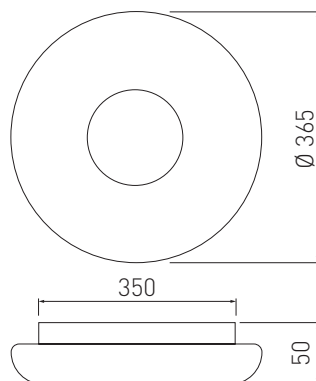



PL Plafoniera LED z mikrofalowym czujnikiem ruchu
 EN LED ceiling light fitting with microwave sensor
 RU LED светильник с микроволновым датчиком движения
 DE LED Plafonnier mit einem Mikrowellenbewegungssensor
 HU Mikrohullámú mozgásérzékelővel felszerelt mennyezeti lámpa

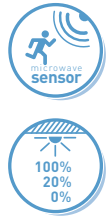

Technical & industrial fixtures

TOKIO

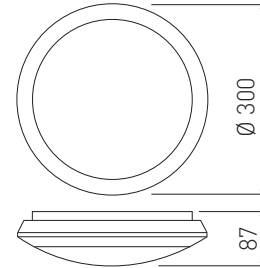

LD-TOK16WD-40	16 W	● 4000 K	1200 lm	PC/PC	biała, white, белый, weiß, fehé	1000 g	5902801001840
LD-TOK22WD-40	22 W		2000 lm				5902801001826



PL Plafoniera LED z mikrofalowym czujnikiem zmierzchowym
 EN LED ceiling light fitting with dusk sensor
 RU LED светильник с сумеречным датчиком
 DE LED Plafonnier mit einem Dämmerungsschalter
 HU Mikrohullámú mozgásérzékelővel felszerelt Alkonyat érzékelő



TOKIO

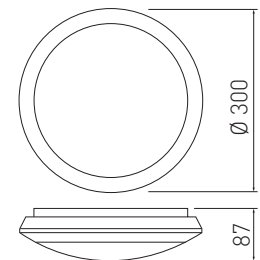

LD-TOK16WP-40	16 W	● 4000 K	1200 lm	PC/PC	biała, white, белый, weiß, fehé	1000 g	5902801001840



- PL Plafoniera LED z mikrofalowym czujnikiem ruchu
- EN LED ceiling fixture with microwave motion sensor
- RU Светодиодный плафон с микроволновым датчиком движения
- DE LED-Deckenleuchte mit Mikrowellen-Bewegungsmelder
- HU Mikrohullámú mozgásérzékelővel felszerelt mennyezeti lámpa

WENUS

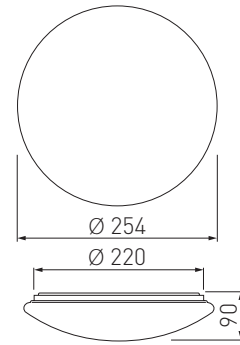

LD-WENUSD13-LED	13 W	4000 K	1100 lm	tworzywo sztuczne, plastic, пластмасса, Kunststoff, anyag	biała, white, белый, weiß, fehér	450 g	5902801033353

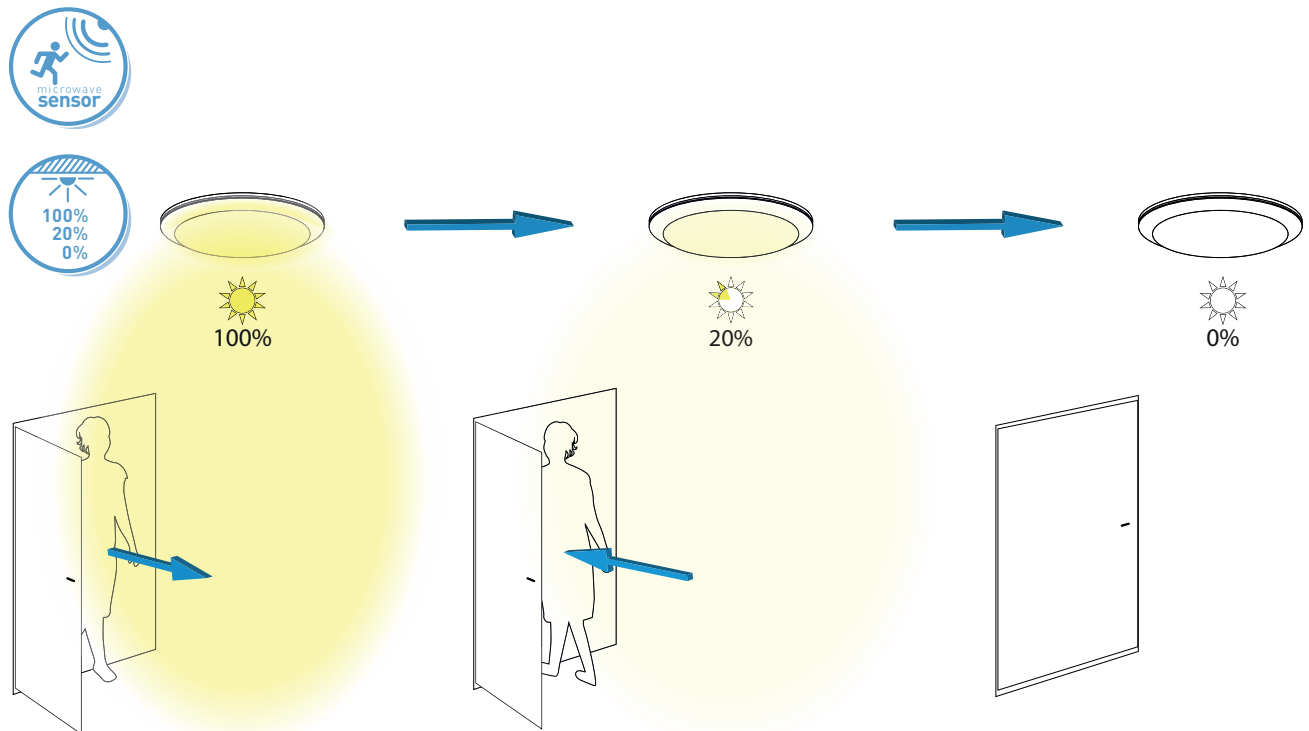

PL Plafoniera LED
EN LED ceiling light fitting
RU Светильник потолочный
DE LED-Deckenleuchte
HU LED-es mennyezeti lámpa

WENUS DUO

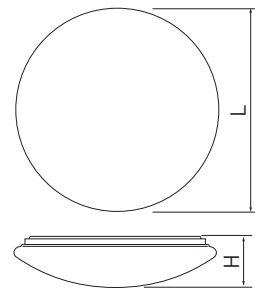

LD-WEND13W-40	13 W	● 4000 K	800 lm	akryl, acrylic, акрил, Acryl, akril	260 × 90	biała, white, белый, weiß, fehé	461 g	5901867190628
LD-WEND18W-40	18 W		1200 lm		335 × 105		560 g	5901867190529
LD-WEND24W-40	24 W		1500 lm		380 × 105		580g	5901867190642



PL Plafoniera LED z mikrofalowym czujnikiem ruchu
EN LED ceiling light fitting with a microwave
RU LED светильник с микроволновым датчиком движения
DE LED-Deckenleuchte mit Mikrowellen-Bewegungsmelder
HU Mikrohullámú mozgásérzékelővel felszerelt mennyezeti lámpa

WENUS DUO

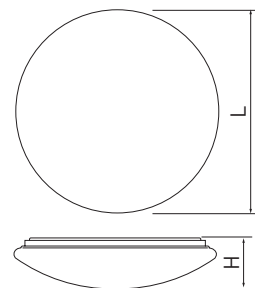

LD-WENDM18W-40	18 W	● 4000 K	1200 lm	akryl, acrylic, акрил, Acryl, akril	335 × 105	biała, white, белый, weiß, fehé	571 g	5901867190581
LD-WENDM24W-40	24 W		1500 lm		380 × 105		590 g	5901867190604



- PL Plafoniera LED z czujnikiem ruchu
- EN LED ceiling light fitting with motion sensor
- RU LED светильник с датчиком движения
- DE LED-Deckenleuchte mit Bewegungsmelder
- HU Mozgásérzékelős mennyezeti lámpatest LED

ITALIA

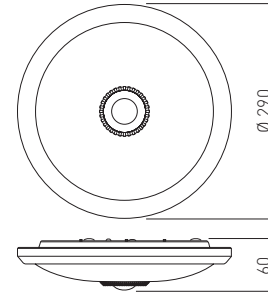

OS-ITL12W-LED	12 W	● 4000 K	1200 lm	PC	biała, white, белый, weiß, fehé	560 g	5901867158291
OS-ITL16W-LED	16 W						5901867197016



Technical & industrial fixtures

- PL Plafoniera LED z czujnikiem ruchu
- EN LED ceiling light fitting with motion sensor
- RU LED светильник с датчиком движения
- DE LED-Deckenleuchte mit Bewegungsmelder
- HU Mozgásérzékelős mennyezeti lámpatest LED

ATOMIKA

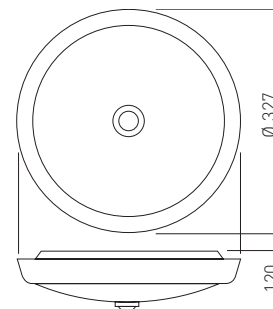

LD-ATO18W-40	18 W	● 4000 K	1200 lm	akryl, acrylic, акрил, Акрил	biała, white, белый, weiß, fehé	394 g	5901867190543



PL Plafoniera LED z czujnikiem ruchu
 EN LED Ceiling light fitting with motion sensor
 RU LED Светильник с датчиком движения
 DE LED-Deckenleuchte mit Bewegungsmelder
 HU LED Mennyezeti lámpa mozgásérzékelővel



LOGOS

Technical & industrial fixtures



LD-LOG16W-LED	16 W	● 4000 K	1200 lm	tworzywo sztuczne, plastic, пластмасса, Kunststoff, anyag	biała, white, белый, weiß, fehér	508 g	5901867197085

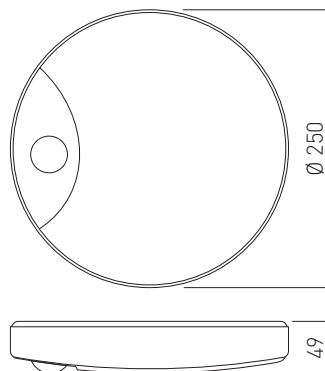



PL Oprawa kanałowa LED
 EN LED Bulkhead fixtures
 RU Канальный светодиодный светильник LED
 DE Robuste Wand-/Deckenleuchte LED
 HU Mélysugárzó lámpatest LED

LUXIA

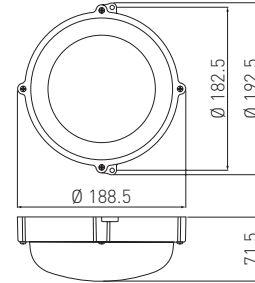

Technical & industrial
fixtures



LD-KALU100K-40	10 W	● 4000 K	700 lm	PC / PC	biała, white, белый, weiß, fehè	250 g	5901867169204
----------------	------	----------	--------	---------	---	-------	---------------



PL Oprawa kanałowa LED
 EN LED Bulkhead fixtures
 RU Канальный светодиодный светильник LED
 DE Robuste Wand-/Deckenleuchte LED
 HU Mélysugárzó lámpatest LED

LUXIA

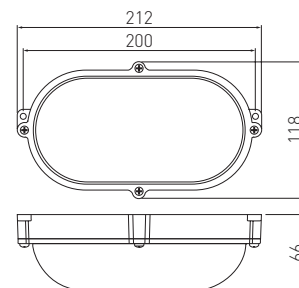

LD-KALU10OW-40	10 W	● 4000 K	700 lm	PC / PC	biała, white, белый, weiß, fehè	250 g	5901867169228
----------------	------	----------	--------	---------	---	-------	---------------



PL Oprawa LED
EN LED fixture
RU Светодиодный светильник
DE Leuchte LED
HU LED lámpatest

TWIST

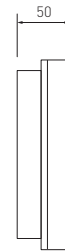
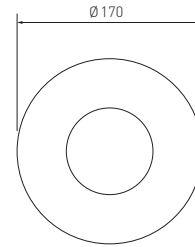

LD-TW110WOK-40	10 W	● 4000 K	750 lm	PC	czarny, black, черный, schwarz, fekete	300 g	5902801041303
----------------	------	----------	--------	----	---	-------	---------------



Technical & industrial
fixtures

PL Oprawa LED
EN LED fixture
RU Светодиодный светильник
DE Leuchte LED
HU LED lámpatest

TWIST

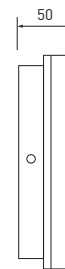
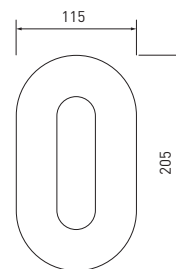

LD-TW110WOW-40	10 W	● 4000 K	750 lm	PC	czarny, black, черный, schwarz, fekete	300 g	5902801042058
----------------	------	----------	--------	----	---	-------	---------------



PL Oprawa kanałowa LED
 EN LED Bulkhead fixtures
 RU Канальный светодиодный светильник LED
 DE Robuste Wand-/Deckenleuchte LED
 HU Mélysugárzó lámpatest LED

DELTA

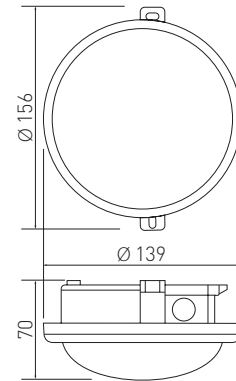

Technical & industrial
fixtures



LD-DELR6W0-NB	6 W	● 4000 K	400 lm	ABS / PC	biały, white, белый, weiß, fehér	170 g	5901867191083
---------------	-----	----------	--------	----------	-------------------------------------	-------	---------------



PL Oprawa kanałowa LED
 EN LED Bulkhead fixtures
 RU Канальный светодиодный светильник LED
 DE Robuste Wand-/Deckenleuchte LED
 HU Mélysugárzó lámpatest LED

DELTA

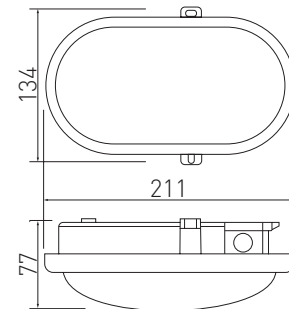

LD-DELOW6W0-NB	6 W	● 4000 K	400 lm	ABS / PC	biały, white, белый, weiß, fehér	170 g	5901867191090
----------------	-----	----------	--------	----------	-------------------------------------	-------	---------------



- PL Oprawa kanałowa LED z czujnikiem ruchu
- EN Bulkhead fixture LED with motion sensor
- RU Канальный светодиодный светильник с датчиком движения
- DE Robuste LED-Leuchte mit Bewegungsmelder
- HU Mozgásérzékelővel hajólámpa LED

DELTA

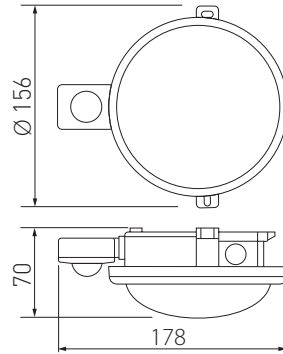

LD-DEOR6WC-NB	6 W	● 4000 K	400 lm	ABS / PC	biały, white, белый, weiß, fehér	207 g	5901867191106
---------------	-----	----------	--------	----------	-------------------------------------	-------	---------------



- PL Oprawa kanałowa LED z czujnikiem ruchu
- EN Bulkhead fixture LED with motion sensor
- RU Канальный светодиодный светильник с датчиком движения
- DE Robuste LED-Leuchte mit Bewegungsmelder
- HU Mozgásérzékelővel hajólámpa LED

DELTA

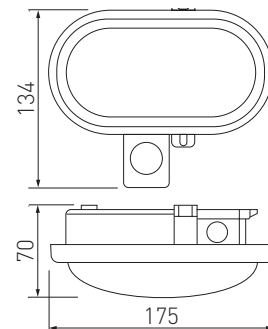

LD-DELOW6WC-NB	6 W	● 4000 K	400 lm	ABS / PC	biały, white, белый, weiß, fehér	207 g	5901867191113
----------------	-----	----------	--------	----------	-------------------------------------	-------	---------------



Technical & industrial
fixtures





OPRAWY LED TYPU DOWNLIGHT
DOWNLIGHTS
СВЕТИЛЬНИКИ ТИПА DOWNLIGHT
DOWNLIGHT
DOWNLIGHT TÍPUSÚ LÁMPATESTEK

- PL Oprawa LED typu downlight natynkowa
 EN Surface mounted LED downlight
 RU Светодиодный накладной светильник downlight
 DE Downlight-LED-Leuchte für Aufputzmontage
 HU Downlight típusú vakolat feletti LED lámpatest

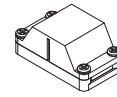

Akcesoria,
Accessories,
Аксессуары,
Zubehör,
Tartozékok:
LZ-KOI2KO-10

ORIS PLUS

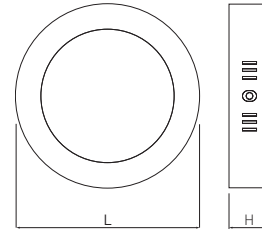

Folder	W	Color	lm	LxH mm	PF	Weight	Barcode
LD-ORN07W-CBP	7 W	3000 K	560 lm	ø 120 x 32	PF > 0,5	340 g	5902801243080
LD-ORN07W-NBP		4000 K					5902801243271
LD-ORN13W-CBP	13 W	3000 K	1020 lm	ø 170 x 32		490 g	5902801243486
LD-ORN13W-NBP		4000 K					5902801243028
LD-ORN19W-CBP	19 W	3000 K	1520 lm	ø 224 x 32		610 g	5902801242779
LD-ORN19W-NBP		4000 K					5902801243523
LD-ORN24W-CBP	24 W	3000 K	2000 lm	ø 303 x 32		1000 g	5902801243417
LD-ORN24W-NBP		4000 K					5902801243738



Technical & industrial fixtures



- PL Oprawa LED typu downlight wpuszczana
 EN Recessed LED downlight
 RU Светодиодный встраиваемый светильник downlight
 DE Downlight-LED-Leuchte für Einlass-Montage
 HU Süllyesztett LED lámpatest

ORIS PLUS

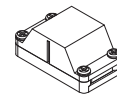

Akcesoria,
Accessories,
Аксессуары,
Zubehör,
Tartozékok:
LZ-KOI2KO-10

Folder	W	Color	lm	Material	LxH mm	PF	Weight	Barcode
LD-ORW03W-CBP	3 W	3000 K	200 lm	aluminium aluminium алюминий Aluminium aluminium	ø 90 x 22	PF > 0,5	150 g	5902801243066
LD-ORW03W-NBP		4000 K						5902801243318
LD-ORW07W-CBP	7 W	3000 K	560 lm		ø 118 x 22		220 g	5902801243073
LD-ORW07W-NBP		4000 K						5902801243165
LD-ORW13W-CBP	13 W	3000 K	1020 lm		ø 168 x 22		350 g	5902801243035
LD-ORW13W-NBP		4000 K						5902801243042
LD-ORW19W-CBP	19 W	3000 K	1520 lm		ø 225 x 22		550 g	5902801243578
LD-ORW19W-NBP		4000 K						5902801243134
LD-ORW24W-CBP	24 W	3000 K	2000 lm		ø 300 x 22		880 g	5901867127624
LD-ORW24W-NBP		4000 K						5901867158390





PL Oprawa LED typu downlight natynkowa
EN Surface mounted LED downlight
RU Светодиодный накладной светильник downlight
DE Downlight-LED-Leuchte für Aufputzmontage
HU Downlight típusú vakolat feletti LED lámpatest

MATIS PLUS

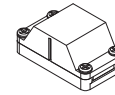

Akcesoria,
Accessories,
Аксессуары,
Zubehör,
Tartozékok:
LZ-KOI2KO-10

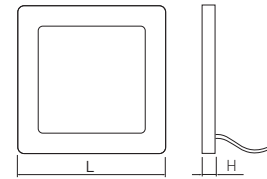

	W	Color	lm	Material	LxH mm	PF	Weight	Barcode
LD-MAN07W-CBP	7 W	3000 K	560 lm	aluminium aluminium алюминий Aluminium aluminium	120 x 32	PF > 0,5	340 g	5902801244186
LD-MAN07W-NBP		4000 K						5902801244087
LD-MAN13W-CBP	13 W	3000 K	1020 lm		170 x 32		490 g	5902801244179
LD-MAN13W-NBP		4000 K						5902801244445
LD-MAN19W-CBP	19 W	3000 K	1520 lm		223 x 32		750 g	5902801244452
LD-MAN19W-NBP		4000 K						5902801244414
LD-MAN24W-CBP	24 W	3000 K	2000 lm		300 x 32		1300 g	5902801243776
LD-MAN24W-NBP		4000 K						5902801243332



PL Oprawa LED typu downlight wpuszczana
EN Recessed LED downlight
RU Светодиодный встраиваемый светильник downlight
DE Downlight-LED-Leuchte für Einlass-Montage
HU Süllyesztett LED lámpatest

MATIS PLUS

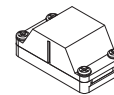

Akcesoria,
Accessories,
Аксессуары,
Zubehör,
Tartozékok:
LZ-KOI2KO-10

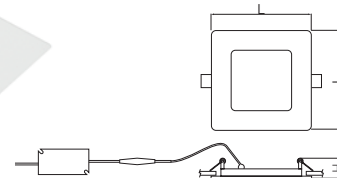

	W	Color	lm	Material	LxH mm	PF	Weight	Barcode
LD-MAW03W-CBP	3 W	3000 K	200 lm	aluminium aluminium алюминий Aluminium aluminium	86 x 22	PF > 0,5	150 g	5902801243448
LD-MAW03W-NBP		4000 K						5902801243653
LD-MAW07W-CBP	7 W	3000 K	560 lm		120 x 22		240 g	5902801243721
LD-MAW07W-NBP		4000 K						5902801243615
LD-MAW13W-CBP	13 W	3000 K	1020 lm		170 x 22		400 g	5902801243462
LD-MAW13W-NBP		4000 K						5902801243912
LD-MAW19W-CBP	19 W	3000 K	1520 lm		224 x 22		640 g	5902801243639
LD-MAW19W-NBP		4000 K						5902801243981
LD-MAW24W-CBP	24 W	3000 K	2000 lm		300 x 22		1100 g	5902801244155
LD-MAW24W-NBP		4000 K						5902801244056



PL Oprawa LED typu downlight
EN Recessed LED downlight
RU Светодиодный накладной светильник downlight
DE Downlight-LED-Leuchte
HU Süllyesztett LED lámpatest

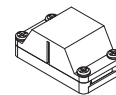

Aksesoria,
Accessories,
Аксессуары,
Zubehör,
Tartozékok:
LZ-KOI2KO-10

MOZA

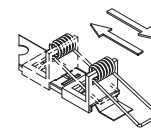
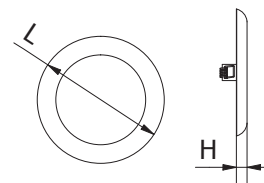

LD-MZ12WOK-NB	12 W	● 4000 K	1000 lm	PC	ø 180 × 16	fi 65-155 mm	300 g	5902801229497
LD-MZ18WOK-NB	18 W		1500 lm		ø 230 × 16	fi 65-205 mm	390 g	5902801229329



PL Oprawa LED typu downlight
EN Recessed LED downlight
RU Светодиодный накладной светильник downlight
DE Downlight-LED-Leuchte
HU Süllyesztett LED lámpatest

MOZA

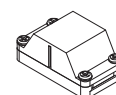

Aksesoria,
Accessories,
Аксессуары,
Zubehör,
Tartozékok:
LZ-KOI2KO-10

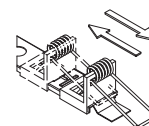
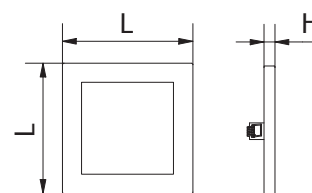

LD-MZ12WKW-NB	12 W	● 4000 K	1000 lm	PC	180 × 16	Ø 65 mm Ø 155 mm	480 g	5902801229510
LD-MZ18WKW-NB	18 W		1500 lm		230 × 16	Ø 65 mm Ø 155 mm	570 g	5902801229428



- PL Oprawa LED typu downlight 2 w 1 natynkowa/wpuszczana
- EN LED downlight fixtures 2 in 1 surface mounted/recessed
- RU Светодиодный светильник 2 в 1 накладной / встраиваемый
- DE LED-Einbauleuchten 2 in 1 Aufbau / Einbau
- HU LED-es mennyezeti lámpatestek 2 in 1 felületre szerelt / süllyesztett

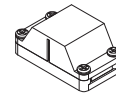

Akcesoria,
Accessories,
Аксессуары,
Zubehör,
Tartozékok:
LZ-KOI2KO-10

SAMBA

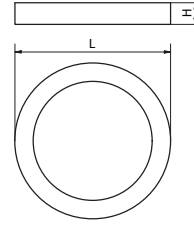

LD-SMBOK09W-21	9 W	● 4000 K	675 lm	PC	ø 115 x 35	PF > 0,5	150 g	5902801219504
LD-SMBOK16W-21	16 W		1200 lm		ø 177 x 35		300 g	5902801074202
LD-SMBOK20W-21	20 W		1600 lm		ø 245 x 35		515 g	5902801073328



- PL Oprawa LED typu downlight 2 w 1 natynkowa/wpuszczana
- EN LED downlight fixtures 2 in 1 surface mounted/recessed
- RU Светодиодный светильник 2 в 1 накладной / встраиваемый
- DE LED-Einbauleuchten 2 in 1 Aufbau / Einbau
- HU LED-es mennyezeti lámpatestek 2 in 1 felületre szerelt / süllyesztett

SAMBA

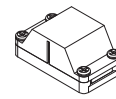

Akcesoria,
Accessories,
Аксессуары,
Zubehör,
Tartozékok:
LZ-KOI2KO-10



LD-SMBKW09W-21	9 W	● 4000 K	675 lm	PC	115 x 35	PF > 0,5	180 g	5902801219344
LD-SMBKW16W-21	16 W		1200 lm		171 x 35		365 g	5902801074219
LD-SMBKW24W-21	24 W		1800 lm		226 x 35		565 g	5902801073304

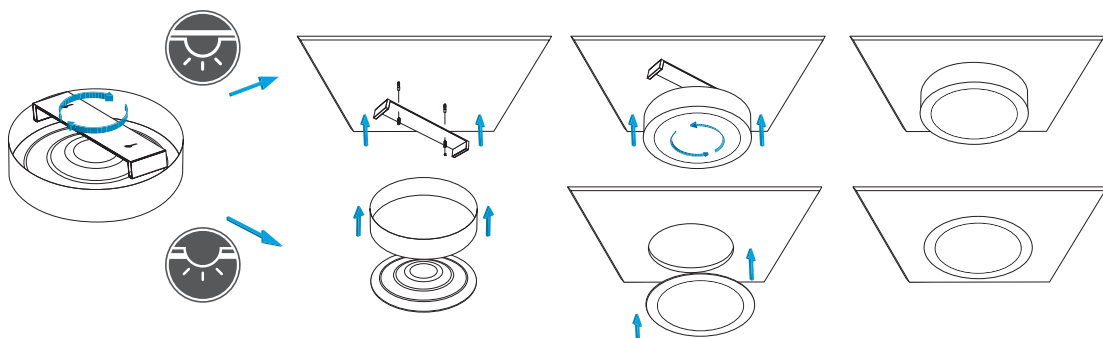

Technical & industrial fixtures

PL Oprawa LED typu downlight 2 w 1 natynkowa/wpuszczana
 EN LED downlight fixtures 2 in 1 surface mounted/recessed
 RU Светодиодный светильник 2 в 1 накладной / встраиваемый
 DE LED-Einbauleuchten 2 in 1 Aufbau / Einbau
 HU LED-es mennyezeti lámpatestek 2 in 1 felületre szerelt / süllyesztett

BOLERO

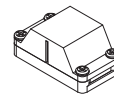

Aksesoria,
Accessories,
Аксессуары,
Zubehör,
Tartozékok:
LZ-KOI2KO-10

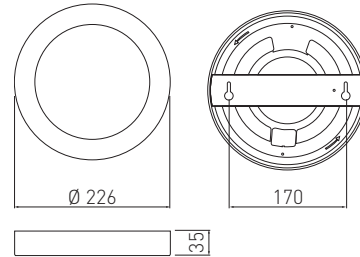

TRI-COLOR



LD-BLROK18W-61	18 W	<ul style="list-style-type: none"> ● 3000 K ● 4000 K ● 6400 K 	1600 lm	aluminium, PC aluminium, PC алюминий, PC Aluminium, PC aluminium, PC	560 g	5902801020117
----------------	------	--	---------	--	-------	---------------



PL Oprawa LED typu downlight 2 w 1 natynkowa/wpuszczana
 EN LED downlight fixtures 2 in 1 surface mounted/recessed
 RU Светодиодный светильник 2 в 1 накладной / встраиваемый
 DE LED-Einbauleuchten 2 in 1 Aufbau / Einbau
 HU LED-es mennyezeti lámpatestek 2 in 1 felületre szerelt / süllyesztett

BOLERO

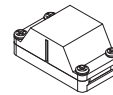

Aksesoria,
Accessories,
Аксессуары,
Zubehör,
Tartozékok:
LZ-KOI2KO-10

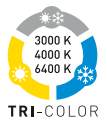
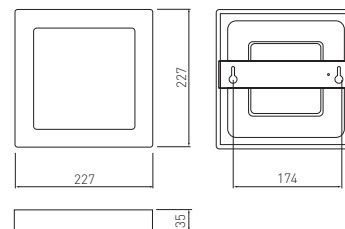

TRI-COLOR



LD-BLRKW18W-61	18 W	<ul style="list-style-type: none"> ● 3000 K ● 4000 K ● 6400 K 	1600 lm	aluminium, PC aluminium, PC алюминий, PC Aluminium, PC aluminium, PC	475 g	5902801020100
----------------	------	--	---------	--	-------	---------------



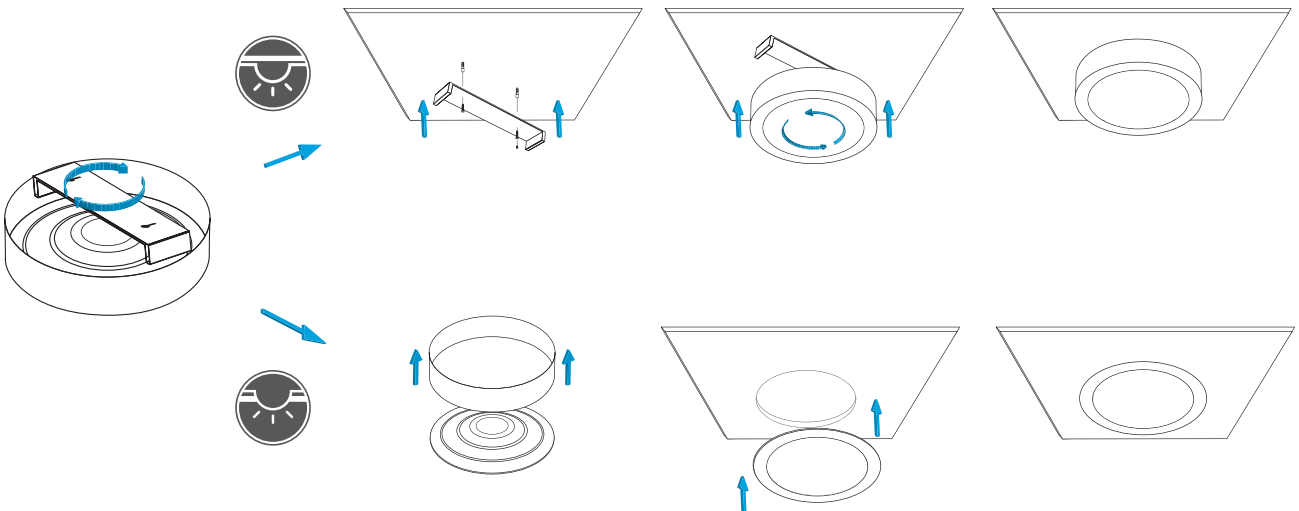
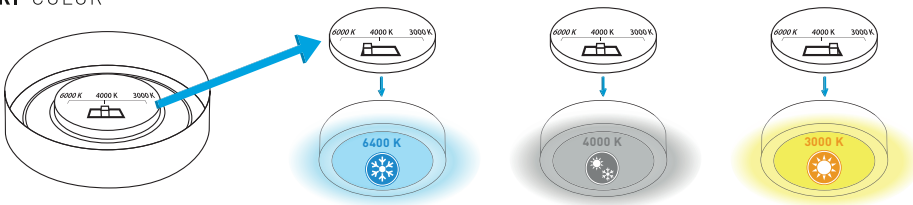

PL Oprawa LED typu downlight natynkowa
EN Surface mounted LED downlight
RU Светодиодный накладной светильник downlight
DE Downlight-LED-Leuchte für Aufputzmontage
HU Downlight típusú vakolat feletti LED lámpatest

TWINS

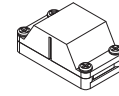
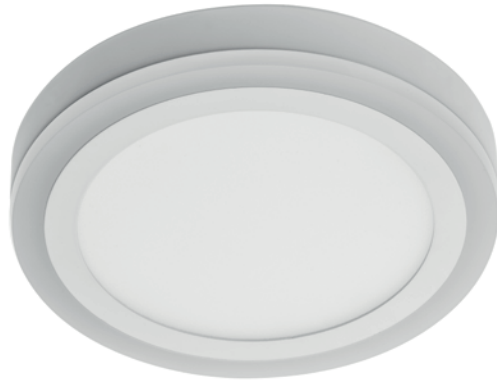

Akcesoria,
Accessories,
Аксессуары,
Zubehör,
Tartozékok:
LZ-KOI2KO-10

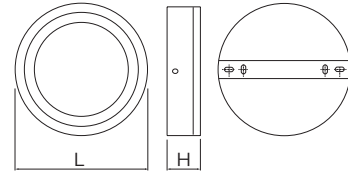

LD-TWN09W-CB	9 W (6W+3W)	● 3000 K	640 lm	aluminium, PC aluminium, PC	ø 147 × 37	290 g	5901867191045
LD-TWN16W-CB	16 W (12W+4W)		1140 lm	алюминий, PC Aluminium, PC aluminium, PC	ø 195 × 37	480 g	5901867191052



PL Oprawa LED typu downlight wpuszczana
EN Recessed LED downlight
RU Светодиодный встраиваемый светильник downlight
DE Downlight-LED-Leuchte für Einlass-Montage
HU Süllyesztett LED lámpatest

TWINS

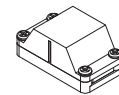

Akcesoria,
Accessories,
Аксессуары,
Zubehör,
Tartozékok:
LZ-KOI2KO-10

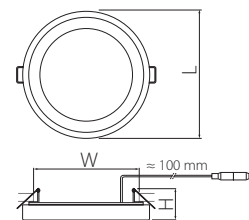

LD-TWW09W-CB	9 W (6W+3W)	● 3000 K	640 lm	aluminium, PC aluminium, PC	ø 145 × 130 × 30	200 g	5901867191069
LD-TWW16W-CB	16 W (12W+4W)		1140 lm	алюминий, PC Aluminium, PC aluminium, PC	ø 190 × 175 × 30	324 g	5901867191076



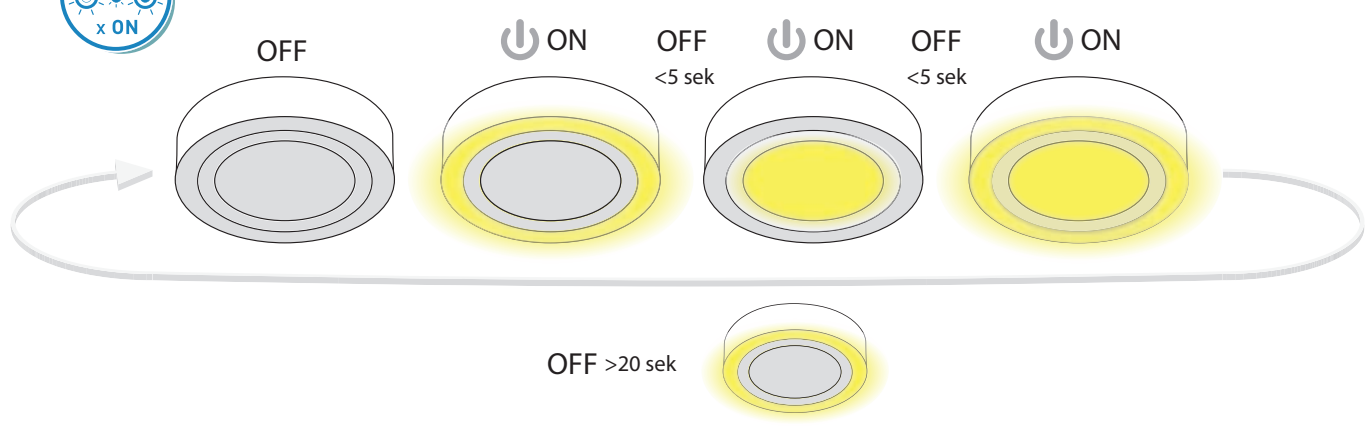

PL Oprawa LED typu downlight wpuszczana
EN Recessed LED downlight
RU Светодиодный встраиваемый светильник downlight
DE Downlight-LED-Leuchte für Einlass-Montage
HU Süllyesztett LED lámpatest

SOLERO II

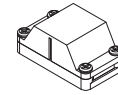

Akcesoria,
Accessories,
Аксессуары,
Zubehör,
Tartozékok:
LZ-KOI2KO-10

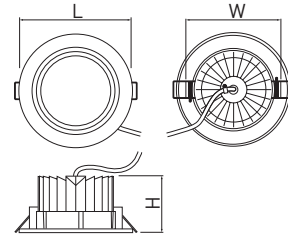

LD-SO206W-NB	6 W	● 4000 K	420 lm	aluminium aluminium алюминий Aluminium aluminium	ø 100 × 90 × 60	PF > 0,5	160 g	5901867190932
LD-SO212W-NB	12 W		880 lm		ø 130 × 110 × 65		346 g	5901867190949
LD-SO218W-NB	18 W		1350 lm		ø 160 × 150 × 75		496 g	5901867190956
LD-SO224W-NB	24 W		1600 lm		ø 190 × 175 × 75		646 g	5901867190963



PL Oprawa LED typu downlight wpuszczana
EN Recessed LED downlight
RU Светодиодный встраиваемый светильник downlight
DE Downlight-LED-Leuchte für Einlass-Montage
HU Süllyesztett LED lámpatest

VERIS

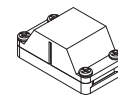

Akcesoria,
Accessories,
Аксессуары,
Zubehör,
Tartozékok:
LZ-KOI2KO-10

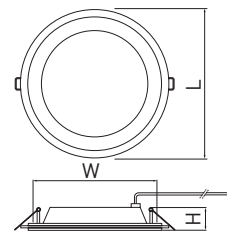

LD-VEW06W-CB	6 W	● 3000 K	400 lm	szkło, aluminium glass, aluminium стекло, алюминий Glas, Aluminium üveg, aluminium	ø 100 × 75 × 30	175 g	5901867191014
LD-VEW12W-CB	12 W		700 lm		ø 160 × 130 × 32	350 g	5901867191021
LD-VEW18W-CB	18 W		1300 lm		ø 200 × 170 × 32	540 g	5901867191038





PL Oprawa LED typu downlight wpuszczana
EN Recessed LED downlight
RU Светодиодный встраиваемый светильник downlight
DE Downlight-LED-Leuchte für Einlass-Montage
HU Süllyesztett LED lámpatest

VOLARE

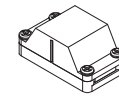

Aksesoria,
Accessories,
Аксессуары,
Zubehör,
Tartozékok:
LZ-KOI2KO-10

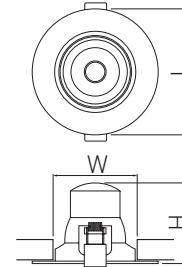

LD-VLROK0538-CB	5 W	● 3000 K	400 lm	ø 90 × 75 × 45	PC	75 g	5902801015830
LD-VLROK1038-CB	10 W		800 lm	ø 104 × 80 × 60		120 g	5902801015885



PL Oprawa LED typu downlight wpuszczana
EN Recessed LED downlight
RU Светодиодный встраиваемый светильник downlight
DE Downlight-LED-Leuchte für Einlass-Montage
HU Süllyesztett LED lámpatest

VOLARE

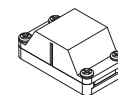

Aksesoria,
Accessories,
Аксессуары,
Zubehör,
Tartozékok:
LZ-KOI2KO-10

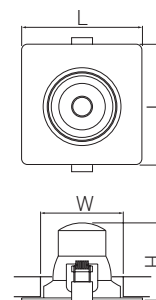

LD-VLRKW0538-CB	5 W	● 3000 K	400 lm	90 × 75 × 45	PC	75 g	5902801015823
LD-VLRKW1038-CB	10 W		800 lm	104 × 80 × 60		120 g	5902801015854



Technical & industrial
fixtures



PL Oprawa LED typu downlight wpuszczana
 EN Recessed LED downlight
 RU Светодиодный встраиваемый светильник downlight
 DE Downlight-LED-Leuchte für Einlass-Montage
 HU Süllyesztett LED lámpatest

Akcesoria,
 Accessories,
 Аксессуары,
 Zubehör,
 Tartozékok:
 LZ-KO12KO-10

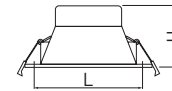
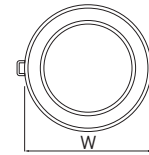
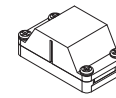

TORONTO



Model	Power (W)	Color Temp (K)	Beam Angle (°)	Material	Dimensions (mm)	Weight (g)	Barcode
LD-TOR08W-NB	8 W	● 4000 K	600 lm	aluminium, PC aluminium, PC алюминий, PC Aluminium, PC aluminium, PC	ø 90-100 × 115 × 58	135 g	5901867190970
LD-TOR12W-NB	12 W		900 lm		ø 120-130 × 145 × 61	189 g	5901867190987
LD-TOR20W-NB	20 W		1600 lm		ø 155-170 × 190 × 75	288 g	5901867190994
LD-TOR24W-NB	24 W		1900 lm		ø 185-205 × 225 × 85	379 g	5901867191007



PL Oprawa LED typu downlight wpuszczana
 EN Recessed LED downlight
 RU Светодиодный встраиваемый светильник downlight
 DE Downlight-LED-Leuchte für Einlass-Montage
 HU Süllyesztett LED lámpatest

Akcesoria,
 Accessories,
 Аксессуары,
 Zubehör,
 Tartozékok:
 LZ-KO12KO-10

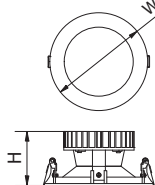
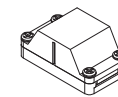

FARO



Model	Power (W)	Color Temp (K)	Beam Angle (°)	Material	Dimensions (mm)	Weight (g)	Barcode
LD-FAR10W-40	10 W	● 4000 K	800 lm	aluminium aluminium алюминий Aluminium aluminium	ø 90-100 × 110 × 70	410 g	5902801255342
LD-FAR20W-40	20 W		1600 lm		ø 150-160 × 170 × 90	880 g	5902801253201





722

723

724

725

726

727

728

729



NAŚWIETLACZE LED
LED FLOODLIGHTS
СВЕТОДИОДНЫЕ ПРОЖЕКТОРЫ
LED FLUTLICHTSTARAHLER
LED REFLEKTOR

PL Naświetlacz LED
EN LED floodlight
RU Светодиодный прожектор
DE LED-Flutlichtstrahler
HU LED reflektor

VIPER

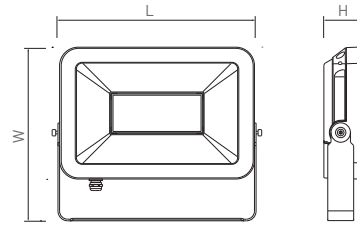

Model	Power (W)	Color Temp (K)	Beam Angle (lm)	Material	Dimensions (mm)	Color	Weight (g)	Barcode
LD-VIPERS30W-40	30 W	4000 K	2700 lm	szkło, aluminium glass, aluminium стекло, алюминий Glas, Aluminium üveg, alumínium	198 × 191 × 33,5	czarny, black, черный, schwarz, fekete	860 g	5902801266195
LD-VIPERS50W-40	50 W		4500 lm		229 × 213,5 × 34,5		1150 g	5902801266263
LD-VIPERS100W-40	100 W		10000 lm		306 × 268 × 58		2200 g	5902801251764
LD-VIPERS150W-40	150 W		15000 lm		367 × 315 × 72		3500 g	5902801251771



Technical & industrial fixtures

PL Naświetlacz LED z czujnikiem ruchu
EN LED floodlight with motion sensor
RU Светодиодный прожектор с датчиком движения
DE LED-Flutlichtscheinwerfer mit Bewegungssensor
HU LED világítás mozgásérzékelővel

iNEXT

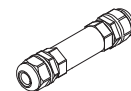

Akcesoria,
Accessories,
Аксессуары,
Zubehör,
Tartozékok:
WZL-2

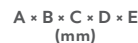
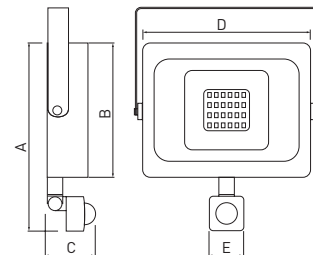

Model	Power (W)	Color Temp (K)	Beam Angle (lm)	Material	Dimensions (mm)	Color	Weight (g)	Barcode
LD-INEXT10W-64	10 W	6400 K	800 lm	aluminium, szkło aluminium, glass алюминий, стекло Aluminium, Glas alumínium, üveg	150 × 88 × 50 × 110 × 40	czarny, black, черный, schwarz, fekete	250 g	5902801007682
LD-INEXT20W-64	20 W		1600 lm		180 × 120 × 50 × 160 × 40		500 g	5902801007699
LD-INEXT30W-64	30 W		2400 lm		180 × 120 × 50 × 160 × 40		800 g	5902801007705
LD-INEXT50W-64	50 W		4000 lm		210 × 145 × 50 × 190 × 40		1200 g	5902801007712



PL Naświetlacz LED
EN LED floodlight
RU Светодиодный прожектор
DE LED-Flutlichtstrahler
HU LED reflektor

iNEXT

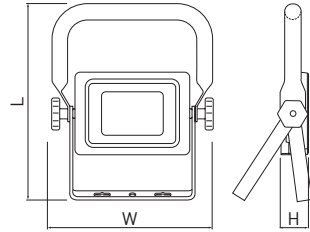

LD-INEXT30WP-64	30 W	6400 K	2400 lm	aluminium, szkło aluminium, glass алюминий, стекло Aluminium, Glas aluminium, üveg	247 × 218 × 38	czarny, black, черный, schwarz, fekete	800 g	5902801007729
LD-INEXT50WP-64	50 W		4000 lm		270 × 256 × 38		1200 g	5902801007736



PL Naświetlacz LED
EN LED floodlight
RU Светодиодный прожектор
DE LED-Flutlichtstrahler
HU LED reflektor

iLUX

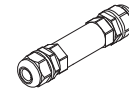

Akcesoria,
Accessories,
Аксессуары,
Zubehör,
Tartozékok:
WZL-2

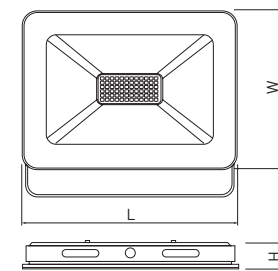

LD-ILUXC10W-64	10 W	6400 K	800 lm	>0,5	PC, szkło PC, glass PC, стекло PC, Glas PC, üveg	128 × 92 × 31	biały, white, белый, weiß, fehér	160 g	5901867191267
LD-ILUXCC10W-64			2400 lm			czarny, black, черный, schwarz, fekete	5902801005268		
LD-ILUXC20W-64	20 W	6400 K	1600 lm	>0,5	PC, szkło PC, glass PC, стекло PC, Glas PC, üveg	170 × 130 × 36	biały, white, белый, weiß, fehér	470 g	5901867191243
LD-ILUXCC20W-64			2400 lm			czarny, black, черный, schwarz, fekete	5902801005282		
LD-ILUXC30W-64	30 W	6400 K	2400 lm	>0,9	PC, szkło PC, glass PC, стекло PC, Glas PC, üveg	230 × 170 × 36	biały, white, белый, weiß, fehér	780 g	5901867191243
LD-ILUXCC30W-64			4000 lm			czarny, black, черный, schwarz, fekete	5902801005305		
LD-ILUXC50W-64	50 W	6400 K	4000 lm	>0,9	PC, szkło PC, glass PC, стекло PC, Glas PC, üveg	300 × 220 × 36	biały, white, белый, weiß, fehér	1230 g	5901867191229
LD-ILUXCC50W-64			4000 lm			czarny, black, черный, schwarz, fekete	5902801005329		



PL Naświetlacz LED
EN LED floodlight
RU Светодиодный прожектор
DE LED-Flutlichtstrahler
HU LED reflektor

iLUX

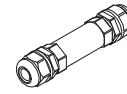

Akcesoria,
Accessories,
Аксессуары,
Zubehör,
Tartozékok:
WZL-2

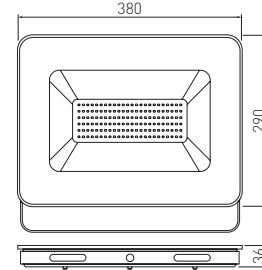

LD-ILUXC100W-64	100 W	6400 K	8000 lm	PC, szkło PC, glass PC, стекло PC, Glas PC, üveg	biały, white белый, weiß, fehér	2000 g	5901867191267
LD-ILUXCC100W-64					czarny, black, черный, schwarz, fekete		5901867191243



PL Naświetlacz LED
EN LED floodlight
RU Светодиодный прожектор
DE LED-Flutlichtstrahler
HU LED reflektor

iMAX

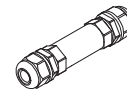

Akcesoria,
Accessories,
Аксессуары,
Zubehör,
Tartozékok:
WZL-2

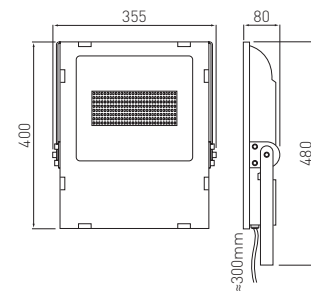

LD-IMAXC200W-64	200 W	6400 K	18000 lm	aluminium, szkło aluminium, glass алюминий, стекло Aluminium, Glas aluminium, üveg	czarny, black, черный, schwarz, fekete	6000 g	5902801000805
-----------------	-------	--------	----------	--	--	--------	---------------





OPRAWY LED TYPU HIGH BAY
HIGH BAY LED LUMINAIRES
СВЕТОДИОДНЫЕ HIGH BAY СВЕТИЛЬНИКИ
HIGHBAY LED-LEUCHTEN
MAGAS LED-ES LÁMPATESTEK

PL High-bay LED
 EN High-bay LED
 RU Светодиодный светильник High Bay
 DE High-bay LED
 HU High-bay LED

ARIZONA

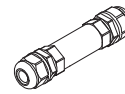

Akcesoria,
 Accessories,
 Аксессуары,
 Zubehör,
 Tartozékok:
 WZL-2

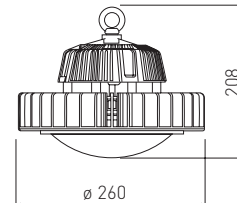

LD-HB150W-40	150 W	● 4000 K	18000 lm	aluminium, aluminium, алюминий Aluminium, alumínium	4500 g	5901867166432
--------------	-------	----------	----------	--	--------	---------------



PL Reflektor do highbaya Arizona
 EN Reflector for highbay Arizona
 RU Рефлектор для highbay Arizona
 DE Reflektor für Arizona-Highbay
 HU Reflektor Arizona High-bayhez

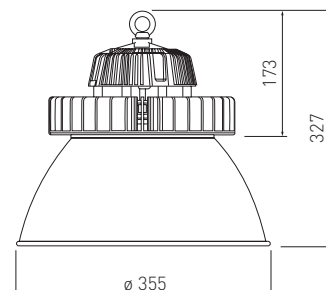

RF-HB150W-40	aluminium, aluminium, алюминий Aluminium, alumínium	szary, grey, серый, grau, szürke	750 g	5901867170583
--------------	--	-------------------------------------	-------	---------------



Technical & industrial
 fixtures

PL High-bay LED
 EN High-bay LED
 RU Светодиодный светильник High Bay
 DE High-bay LED
 HU High-bay LED

TEKSAS

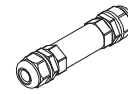

Akcesoria,
 Accessories,
 Аксессуары,
 Zubehör,
 Tartozékok:
 WZL-2

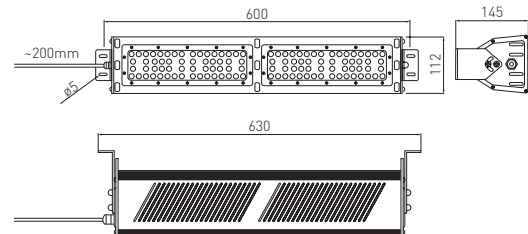

Technical & industrial
 fixtures



LD-TK100W-40	100 W	● 4000 K	12 000 lm	aluminium, aluminium, алюминий, Aluminium, aluminium	szary, grey, серый, grau, szürke	3000 g	5902801001970
--------------	-------	----------	-----------	--	-------------------------------------	--------	---------------



PL Soczewki wymienne
 EN Exchangeable lenses
 RU Сменные линзы
 DE Wechselobjektive
 HU Cserélhető lencsék



SO-TK060DE-00	60° X 60°	5902801008979
SO-TK090DE-00	90° X 90°	5902801008986
SO-TK612DE-00	60° X 120°	5902801008962
SO-TK069DE-00	60° X 90°	5902801024931

PL High-bay LED
EN High-bay LED
RU Светодиодный светильник High Bay
DE High-bay LED
HU High-bay LED

NEVADA

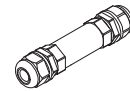

Aksesoria,
Accessories,
Аксессуары,
Zubehör,
Tartozékok:
WZL-2

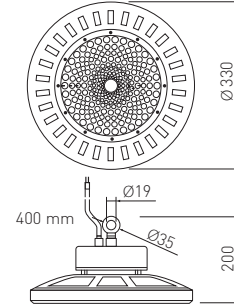

LD-HBN150W-40	150 W	● 4000 K	18000 lm	aluminium, aluminium, алюминий Aluminium, aluminium	czarny, black, черный, schwarz, fekete	3000 g	5902801024443
---------------	-------	----------	----------	---	--	--------	---------------



PL High-bay LED
EN High-bay LED
RU Светодиодный светильник High Bay
DE High-bay LED
HU High-bay LED

MONTANA

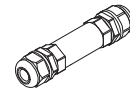

Aksesoria,
Accessories,
Аксессуары,
Zubehör,
Tartozékok:
WZL-2

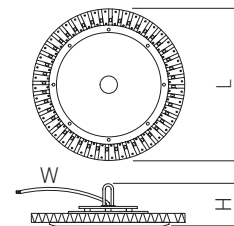

LD-HBM050W-40	50 W	● 4000 K	5000 lm	aluminium, aluminium, алюминий Aluminium, aluminium	ø 270 × 600 × 125	czarny, black, черный, schwarz, fekete	1100 g	5902801008993
LD-HBM100W-40	100 W		10000 lm		ø 305 × 600 × 90		1900 g	5902801009006



Technical & industrial
fixtures



OPRAWY ULICZNE I PARKOWE LED
STREET AND PARK LUMINAIRES LED
СВЕТОДИОДНЫЕ УЛИЧНЫЕ И ПАРКОВЫЕ СВЕТИЛЬНИКИ LED
STRASSEN- UND PARKLEUCHTEN LED
UTCAI ÉS PARKOS LÁMPATESTEK LED

PL Lampa uliczno-parkowa LED
EN Street and Park LED Lamp
RU Светодиодная лампа улично-парковая
DE LED Straßen- und Parkplatzleuchte
HU LED utacai-kerti lámpa

PARKER

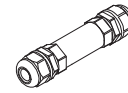

Akcesoria,
Accessories,
Аксессуары,
Zubehör,
Tartozékok:
WZL-2

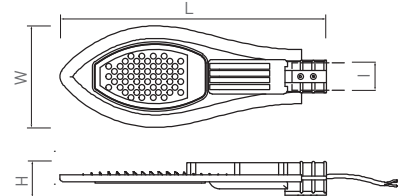

						LxWxHd mm			
LD-PARK30W-40	30 W	● 4000 K	3000 lm	aluminium, aluminium, алюминий Aluminium, aluminium	497 x 173 x 58 x ø38		PF > 0,95	680 g	5902801241895
LD-PARK50W-40	50 W		5000 lm					1270 g	5902801241925



Technical & industrial
fixtures

PL Lampa uliczno-parkowa LED
EN Street and Park LED Lamp
RU Светодиодная лампа улично-парковая
DE LED Straßen- und Parkplatzleuchte
HU LED utacai-kerti lámpa

STELLA

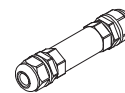

Akcesoria,
Accessories,
Аксессуары,
Zubehör,
Tartozékok:
WZL-2

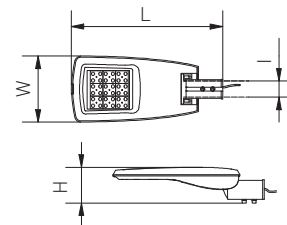

						LxWxHd mm			
LD-STEL080W-40	80 W	● 4000 K	10400 lm	PF > 0,9	aluminium aluminium алюминий Aluminium aluminium	610 x 256 x 145 x ø60		5000 g	5902801202179
LD-STEL150W-40	150 W		20300 lm					7000 g	5902801202209



PL Lampa uliczno-parkowa LED
EN Street and Park LED Lamp
RU Светодиодная лампа улично-парковая
DE LED Straßen- und Parkplatzleuchte
HU LED utacai-kerti lámpa

ROCKET



LD-LUR050W-40



LD-LUR100W-40

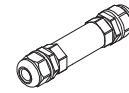

Akcesoria,
Accessories,
Аксессуары,
Zubehör,
Tartozékok:
WZL-2

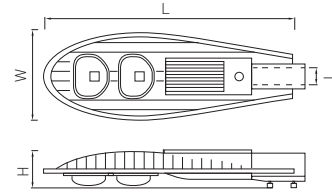

LD-LUR050W-40	50 W	● 4000 K	4500 lm	aluminium aluminium алюминий Aluminium aluminium	510 × 210 × 70 × ø53	2000 g	5901867166418	
LD-LUR100W-40	100 W		9000 lm				720 × 280 × 120 × ø63	4800 g



PL Adapter do opraw uliczno - parkowych
EN Adapter for street fixtures
RU Адаптер для уличных ламп
DE Adapter für Straßen- und Parkleuchten
HU Adapter utcai-parki keretekhez



SA1



SA2

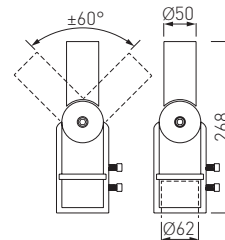

SA1

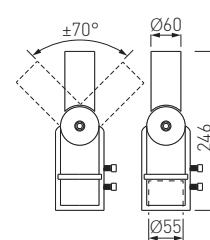

SA2

SA1		680 g	5901867190840
SA2		550 g	5901867190864







OPRAWY AWARYJNE LED
LED EMERGENCY LIGHT FIXTURES
АВАРИЙНЫЕ СВЕТИЛЬНИКИ
LED NOTBELEUCHTUNG
LED VÉSZVILÁGÍTÓK

PL Oprawa sieciowo awaryjna LED
EN Emergency LED mains lamp fixture
RU Аварийный светодиодный светильник
DE LED-Nothinweisleuchte
HU Hálózati LED vészhelyzeti lámpatest

SAHER DUO

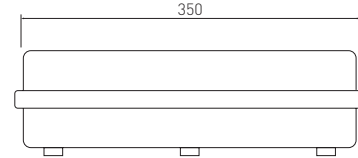
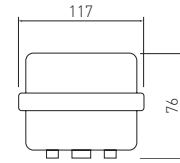

LD-SAHER1-DUO	3 W	1 h	6400 K	300 lm	PC	biały белый weiß fehér	805 g	5901867198280
LD-SAHER3-DUO		3 h					805 g	5901867198273



PL Oprawa oświetlenia awaryjnego LED dwuzadaniowa
EN Two-functional emergency LED fixture
RU Светодиодный двухфункциональный светильник аварийного освещения
DE Bifunktionale LED-Nothinweisleuchte
HU Kétfeladatú vészvilágító LED lámpatest

SALED

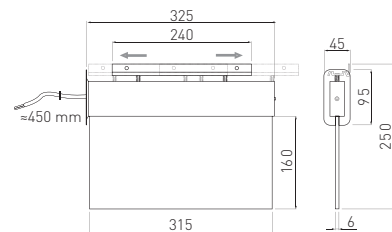

OA-SALED1-08	3 W	1 h	6400 K	aluminium aluminium алюминий Aluminium aluminium	chrom chrome хром Chrom króm	910 g	5908231370440
OA-SALED3-08		3 h				910 g	5908231301956



Technical & industrial fixtures

PL Piktogramy
EN Pictograms
RU Пиктограммы
DE Piktogramme
HU Piktogramok



0A-PIKTO-01
0A-PIKTO-A1



0A-PIKTO-05



0A-PIKTO-07
0A-PIKTO-08



0A-PIKTO-A7
0A-PIKTO-A8



0A-PIKTO-02
0A-PIKTO-A2



0A-PIKTO-01	100x300mm, 150x300mm	5908231301963
0A-PIKTO-A1		5908231302021
0A-PIKTO-05	100x300mm, 150x300mm	5908231302007
0A-PIKTO-07	100x300mm, 150x300mm	5901867125101
0A-PIKTO-08		5901867125118
0A-PIKTO-A7	100x300mm, 150x300mm	5901867125149
0A-PIKTO-A8		5901867125163
0A-PIKTO-02	100x300mm, 150x300mm	5908231301970
0A-PIKTO-A2		5908231302038



**WYJŚCIE
EWAKUACYJNE**



OPRAWY RASTROWE, KLOSZOWE
LOUVRE FITTINGS
РАСТРОВЫЕ СВЕТИЛЬНИКИ
RASTERLEUCHTEN
VÉSZVILÁGÍTÓK

- PL Oprawa rastrowa natynkowa
- EN Surface mounted louvre fitting
- RU Растровый накладной светильник
- DE Aufbaurasterleuchte
- HU Falra szerelhető fénycső lámpatest



Aksesoria,
Accessories,
Аксессуары,
Zubehör,
Tartozékok:



OS-HERZWKPL4-00

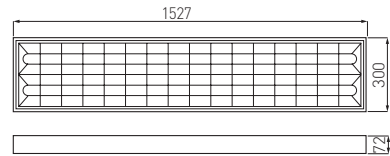

OS-LE150NJ-01	blacha stalowa, steel sheet, стальной лист, Stahlblech, acéllemez	biały, white, белый, weiß, fehér	3750 g	5908231307637
---------------	---	--	--------	---------------



- PL Oprawa rastrowa natynkowa (EVG)
- EN Surface mounted fixture (EVG)
- RU Растровый накладной светильник (EVG)
- DE Aufputz-Rasterleuchte (EVG)
- HU Vakolat feletti raszter lámpatest (EVG)



Aksesoria,
Accessories,
Аксессуары,
Zubehör,
Tartozékok:



OS-HERZWKPL4-00

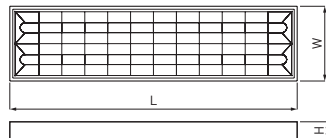

Code	Size	Dimensions (mm)	Material	Color	Weight	Barcode
OS-RE218N-01	2 x 18 W	612 x 300 x 72	korpus: blacha stalowa; raster paraboliczny z poprzeczkami V-kształtnymi	biały white белый weiß fehér	1600 g	5908231332783
OS-RE236N-01	2 x 36 W	1222 x 300 x 72	body: steel sheet; parabolic louvre screen with V-shaped cross-bars		2640 g	5908231302939
OS-RE258N-01	2 x 58 W	1522 x 300 x 72	корпус: листовая сталь; параболический экран с V-образными поперечинами		3800 g	5908231304650
OS-RE418N-01	4 x 18 W	610 x 610 x 72	Korpus: Stahlblech; Parabol-Raster mit V-förmigen Querleisten váz: acéllemez, parabolatükrös lámpatest V alakú rácsozással		2620 g	5908231302946



- PL Oprawa rastrowa wpuszczana (EVG)
- EN Recessed fixture (EVG)
- RU Растровый встраиваемый светильник (EVG)
- DE Aufputz-Rasterleuchte (EVG)
- HU Vakolat feletti raszter lámpatest (EVG)



Akcesoria,
Accessories,
Аксессуары,
Zubehör,
Tartozékok:



OS-QU418W-UC

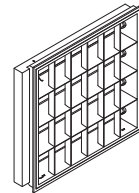
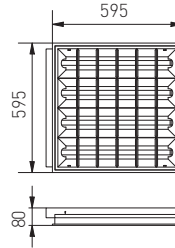
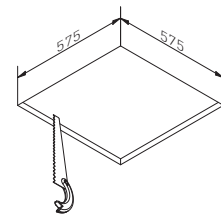

OS-RE418W-01	4 x 18 W	<p>korpus: blacha stalowa; raster paraboliczny z poprzeczkami V-kształtnymi body: steel sheet; parabolic louvre screen with V-shaped cross-bars корпус: листовая сталь; параболический экран с V-образными поперечинами Korpus: Stahlblech; Parabol-Raster mit V-förmigen Querleisten váz: acéllemez; parabolatükrös lámpatest V alakú rácsozással</p>	<p>biały white белый weiß fehér</p>	2740 g	5908231302953
--------------	----------	--	---	--------	---------------



- PL Oprawa rastrowa natynkowa (EVG)
- EN Surface mounted fixture (EVG)
- RU Растровый накладной светильник (EVG)
- DE Aufputz-Rasterleuchte (EVG)
- HU Vakolat feletti raszter lámpatest (EVG)



Akcesoria,
Accessories,
Аксессуары,
Zubehör,
Tartozékok:



OS-HERZWKPL4-00

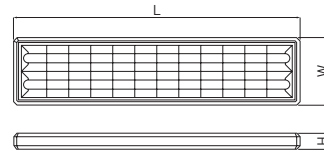

OS-RC236N-01	2 x 36 W	1250 x 300 x 70	<p>korpus: blacha stalowa; raster paraboliczny z poprzeczkami V-kształtnymi body: steel sheet; parabolic louvre screen with V-shaped cross-bars корпус: листовая сталь; параболический экран с V-образными поперечинами</p>	<p>biały white белый weiß fehér</p>	2680 g	5908231365965
OS-RC418N-01	4 x 18 W	640 x 596 x 70	<p>Korpus: Stahlblech; Parabol-Raster mit V-förmigen Querleisten váz: acéllemez; parabolatükrös lámpatest V alakú rácsozással</p>	<p>biały white белый weiß fehér</p>	2800 g	5908231365989



- PL Oprawa modułowa z kloszem wpuszczana (EVG)
- EN Recessed modular fixture with lens (EVG)
- RU Растровый встраиваемый светильник (EVG)
- DE Modulleuchte zum Einlassen (EVG)
- HU Vakolat feletti raszter lámpatest (EVG)

inside
G13
4x18 W



Akcesoria,
Accessories,
Аксессуары,
Zubehör,
Tartozékok:



OS-QU418W-UC

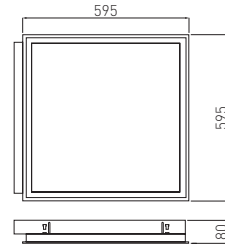

On Request:
compatible
with DALI
>8x



OS-SE418W-01	korpus: stal; klosz mleczny, body: steel; lens: soft white, корпус: сталь, рассеиватель белый матовый, Gehäuse: Stahl; Schirm milchig, test: acél, lencse tejszínű	biały white белый weiß fehér	2850 g	5908231334664
--------------	--	--	--------	---------------

- PL Oprawa modułowa z kloszem natynkowa (EVG)
- EN Surface mounted louvre fixture (EVG)
- RU Растровый накладной светильник (EVG)
- DE Aufputz-Modulleuchte (EVG)
- HU Vakolat feletti raszter lámpatest (EVG)

inside
G13



Akcesoria,
Accessories,
Аксессуары,
Zubehör,
Tartozékok:



OS-HERZWKPL4-00



On Request:
compatible
with DALI
>8x



OS-SC236N-01	2 x 36 W	1250 x 295 x 70	korpus: stal; klosz mleczny, body: steel; lens: soft white, корпус: сталь, рассеиватель белый матовый, Gehäuse: Stahl; Schirm milchig, test: acél, lencse tejszínű	biały white белый weiß fehér	3400 g	5908231304698
OS-SC418N-01	4 x 18 W	640 x 595 x 70		3200 g	5908231304711	



PL Oprawa świetłówkowa
EN Fluorescent fitting
RU Светильник для люминесцентных ламп T8
DE Leuchtstoffröhren-Lampe
HU Fénycsöves lámpatest

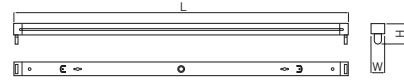

OS-OSE118-00	18 W	620 x 50 x 76	blacha stalowa, steel sheet, стальной лист, Stahlblech, acélleme	biały, white, белый, weiß, fehér	500 g	5908231339560
OS-OSE136-00	36 W	1230 x 50 x 76			820 g	5908231302816
OS-OSE158-00	58 W	1530 x 50 x 76			1100 g	5908231339577



PL Oprawa świetłówkowa
EN Fluorescent fitting
RU Светильник для люминесцентных ламп T8
DE Leuchtstoffröhren-Lampe
HU Fénycsöves lámpatest



OS-OSE218-00	2 x 18 W	620 x 100 x 76	blacha stalowa, steel sheet, стальной лист, Stahlblech, acélleme	biały, white, белый, weiß, fehér	530 g	5908231339584
OS-OSE236-00	2 x 36 W	1230 x 100 x 76			880 g	5908231302793
OS-OSE258-00	2 x 58 W	1530 x 100 x 76			1240 g	5908231339591



PL Oprawa świetłówkowa
EN Fluorescent fitting
RU Светильник для светодиодных ламп T8
DE Leuchtstoffröhrenlampe
HU Fénycsöves lámpatest

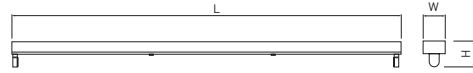

OS-OSL1060S-00	620 × 42 × 47	blacha stalowa, steel sheet, стальной лист, Stahlblech, acéllemez		270 g	5902801017599
OS-OSL1090S-00	920 × 42 × 47			255 g	5901867173720
OS-OSL1120S-00	1230 × 42 × 47			320 g	5901867173737
OS-OSL1150S-00	1530 × 42 × 47			420 g	5901867173751



PL Oprawa świetłówkowa
EN Fluorescent fitting
RU Светильник для светодиодных ламп T8
DE Leuchtstoffröhrenlampe
HU Fénycsöves lámpatest



OS-OSL2120S-00	1230 × 100 × 47	blacha stalowa, steel sheet, стальной лист, Stahlblech, acéllemez		380 g	5901867173744
OS-OSL2150S-00	1530 × 100 × 47			470 g	5901867173768



PL Reflektory do opraw świetłówkowych
 EN Reflectors for luminescent lamps
 RU Рефлекторы для люминесцентных светильников
 DE Reflektoren für Leuchtstoffröhren-Leuchten
 HU Reflektorok fénycsöves lámpatestekhez



INFO



OS-REF136-00	OS-OSE136-00 OS-OSL1120S-00	symetryczny symmetric симметрический symmetrisch zimetrikus	1230 mm	5908231302823
OS-REF158-00	OS-OSE158-00 OS-OSL1150S-00		1530 mm	5908231364692
OS-REF236-00	OS-OSE236-00 OS-OSL21200S-00		1230 mm	5908231302809
OS-REF258-00	OS-OSE258-00 OS-OSL21500S-00		1530 mm	5901867100986







OPRAWY PRZEMYSŁOWE
INDUSTRIAL FIXTURES
ПРОМЫШЛЕННЫЕ СВЕТИЛЬНИКИ
INDUSTRIELEUCHTEN
IPARI LÁMPATESTEK

PL Oprawa LED hermetyczna na źródła światła LED T8
 EN Airtight T8 LED fixture
 RU Светильник для светодиодных источников T8
 DE LED-Leuchte für T8-Leuchtmittel
 HU Lámpatestek T8 LED fényforrások részére

ZEFIR

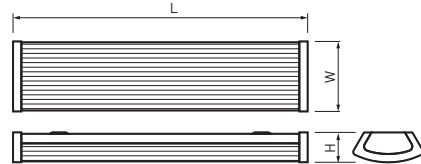
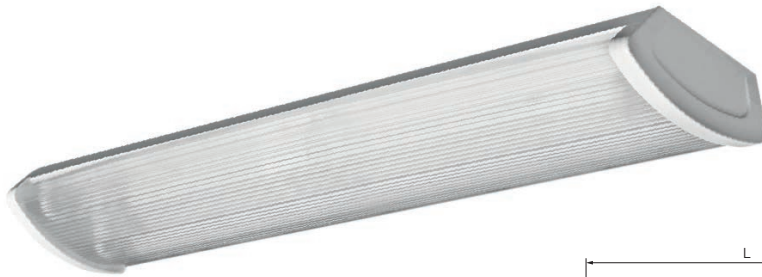

Folder	LxWxH mm	Material	Material	Weight	Barcode
LD-OZE218-00	640 x 152 x 65	ABS, PC, blacha stalowa ABS, PC, steel sheet	przeźroczysty, clear, прозрачный, durchsichtig, átlátszó	700 g	5901867159632
LD-OZE236-00	1250 x 152 x 65	ABS, ПК, листовая сталь ABS, PC, Stahlblech ABS, PC, acéllemez		1000 g	5901867151605



Technical & industrial fixtures

PL Oprawa LED hermetyczna na źródła światła LED T8
 EN Airtight T8 LED fixture
 RU Светильник для светодиодных источников T8
 DE LED-Leuchte für T8-Leuchtmittel
 HU Lámpatestek T8 LED fényforrások részére

ZEFIR

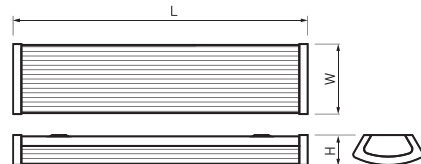

Folder	LxWxH mm	Material	Material	Weight	Barcode
LD-OZE218-01	640 x 152 x 65	ABS, PC, blacha stalowa ABS, PC, steel sheet	mleczny, soft white, белый матовый, milchig, tejszínű	700 g	5901867177582
LD-OZE236-01	1250 x 152 x 65	ABS, ПК, листовая сталь ABS, PC, Stahlblech ABS, PC, acéllemez		1000 g	5901867177698



PL Oprawa świetłówkowa (EVG)
EN Fluorescent fitting (EVG)
RU Линейный светильник (EVG)
DE Leuchtstoffröhrenlampe (EVG)
HU Fénycsöves lámpatest (EVG)

ZEFIR



Akcesoria,
Accessories,
Аксессуары,
Zubehör,
Tartozékok:



OS-HERZWKPL4-00

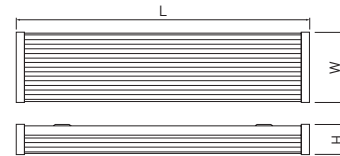

OS-OZE218-00	2 x 18 W	640 x 152 x 65	ABS, PC, blacha stalowa ABS, PC, steel sheet ABS, ПК, листовая сталь	przezroczysty, clear, прозрачный, durchsichtig, átlátszó	1000 g	5908231323088
OS-OZE236-00	2 x 36 W	1250 x 152 x 65	ABS, PC, Stahlblech ABS, PC, acéllemez		2500 g	5908231323095



PL Oprawa świetłówkowa (EVG)
EN Fluorescent fitting (EVG)
RU Линейный светильник (EVG)
DE Leuchtstoffröhrenlampe (EVG)
HU Fénycsöves lámpatest (EVG)

ZEFIR



Akcesoria,
Accessories,
Аксессуары,
Zubehör,
Tartozékok:



OS-HERZWKPL4-00

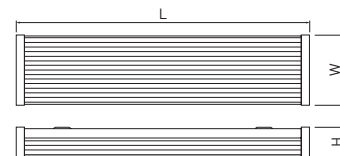

OS-OZE218-01	2 x 18 W	640 x 152 x 65	ABS, PC, blacha stalowa ABS, PC, steel sheet ABS, ПК, листовая сталь	mleczny, soft white, белый матовый, milchig, tejszínű	1000 g	5908231335982
OS-OZE236-01	2 x 36 W	1250 x 152 x 65	ABS, PC, Stahlblech ABS, PC, acéllemez		2500 g	5908231335999



PL Oprawa LED hermetyczna do źródeł światła LED T8
 EN Airtight LED fitting for LED T8 light sources
 RU Герметичный светильник для источников LED T8
 DE Hermetische LED-Leuchte für die Lichtquellen LED T8
 HU Hermetikus LED lámpatest LED T8 fényforráshoz

LOTUS

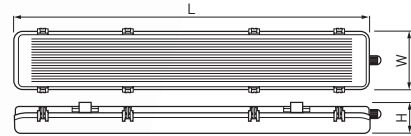

	LxWxH mm				
LD-LOTU218-30	665 × 106 × 60	ABS / PC		510 g	5902801002007
LD-LOTU236-30	1270 × 106 × 60			870 g	5902801002014
LD-LOTU258-30	1570 × 106 × 60			1100 g	5902801002021



PL Oprawa LED hermetyczna do źródeł światła LED T8
 EN Airtight LED fitting for LED T8 light sources
 RU Герметичный светильник для источников LED T8
 DE LED-Feuchtraumleuchte für T8-Lichtmittel
 HU Hermetikus lámpatestek T8 LED fényforrások részére

HAGEN

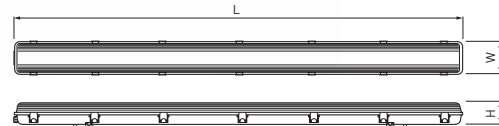

	LxWxH mm				
LD-HAG136-30	1280 × 67 × 50	PC / PC		520 g	5901867194060
LD-HAG158-30	1590 × 67 × 50			900 g	5902801009877
LD-HAG218-30	690 × 115 × 58			1000 g	5901867194053
LD-HAG236-30	1270 × 100 × 60			900 g	5901867154606
LD-HAG258-30	1590 × 110 × 60			1000 g	5901867166395



PL Oprawa LED hermetyczna do źródeł światła LED T8
 EN Airtight LED fitting for LED T8 light sources
 RU Герметичный светильник для источников LED T8
 DE Hermetische LED-Leuchte für die Lichtquellen LED T8
 HU Hermetikus LED lámpatest LED T8 fényforráshoz



HELIOS BIS

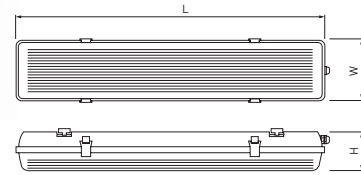

Product Code	Dimensions (LxWxH) mm	Color	Material	Weight (g)	EAN-13
LD-HEL136B-30*	1250 x 152 x 65	szary, grey, серый, grau, szürke	ABS, PS	1500 g	5901867163325
LD-HEL136BPC-30**			ABS, PC	1500 g	5901867186614
LD-HEL218B-30*	640 x 152 x 65		ABS, PS	1500 g	5901867163301
LD-HEL218BPC-30**			ABS, PC	1500 g	5901867186607
LD-HEL236B-30*	1250 x 152 x 65		ABS, PS	1800 g	5901867163349
LD-HEL236BPC-30**			ABS, PC	1800 g	5901867186621
LD-HEL258B-30*	1550 x 152 x 65		ABS, PS	2500 g	5901867163363
LD-HEL258BPC-30**			ABS, PC	2500 g	5901867186638



PL Oprawa hermetyczna ścienna-sufitowa (EVG)
 EN Airtight wall, ceiling lamp fixture (EVG)
 RU Герметичный настенно-потолочный светильник (EVG)
 DE Hermetische Wand-/Deckenleuchte (EVG)
 HU Fali-mennyezeti hermetikus lámpatest (EVG)

HELIOS

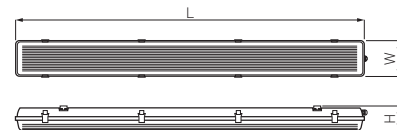

Product Code	Dimensions (LxWxH) mm	Power (W)	Color	Material	Weight (g)	EAN-13
OS-HEL118-30	662 x 85 x 90	18 W	szary, grey, серый, grau, szürke	ABS, PC	1200 g	5908231332479
OS-HEL136-30	1267 x 85 x 90	36 W			1900 g	5908231332486
OS-HEL218-30	662 x 130 x 90	2 x 18 W			1500 g	5908231332509
OS-HEL258-30	1559 x 130 x 90	2 x 58 W			3600 g	5908231322029



- PL Oprawa hermetyczna ścienna-sufitowa (EVG)
- EN Airtight wall, ceiling lamp fixture (EVG)
- RU Герметичный настенно-потолочный светильник (EVG)
- DE Hermetische Wand-/Deckenleuchte (EVG)
- HU Fali-mennyezeti hermetikus lámpatest (EVG)

HEKATE EVG

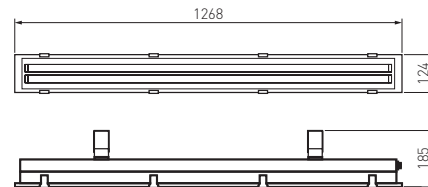

Technical & industrial fixtures

OS-HEK236-30	1268 × 124 × 185	aluminium, szkło hartowane aluminium, tempered glass алюминий, закаленное стекло Aluminium, Gehärtetes Glas aluminium, hőkezelt üveg	szary, grey, серый, grau, szürke	5050 g	5908231332370



- PL Oprawa hermetyczna ścienna-sufitowa (T8 LED)
- EN Airtight wall, ceiling lamp fixture (T8 LED)
- RU Герметичный светильник для светодиодных источников T8
- DE Hermetische Wand-/Deckenleuchte (T8 LED)
- HU Fali-mennyezeti hermetikus lámpatest (T8 LED)

HEKATE T8

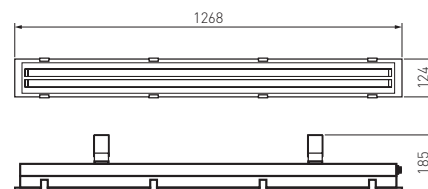

LD-HEK258-30	1568 × 124 × 185	aluminium, szkło hartowane aluminium, tempered glass алюминий, закаленное стекло Aluminium, Gehärtetes Glas aluminium, hőkezelt üveg	szary, grey, серый, grau, szürke	6000 g	5902801025907
LD-HEK236-30	1268 × 124 × 185			5050 g	5901867157966



PL Zapinka metalowa do opraw LOTUS, boczna
 EN Metal clamp for LOTUS fixtures, side
 RU Металлическая защелка для светильников LOTUS, боковая
 DE Metallklammer für LOTUS Leuchten, seitlich
 HU Fém kapcsoló LOTUS keretekhez, oldalsó



LD-LOTB-ME

metal, metal, металл, Metall, fém

5902801002434

PL Zapinka metalowa do opraw HAGEN, boczna
 EN Metal clamp for HAGEN fixtures, side
 RU Металлическая защелка для светильников HAGEN, боковая
 DE Metallklammer für HAGEN Leuchten, seitlich
 HU Fém kapcsoló HAGEN keretekhez, oldalsó



LD-HAG236KL-ME

metal, metal, металл, Metall, fém

5901867189264

PL Linka stalowa
 EN Steel cable
 RU Стальной трос
 DE Stahlleine zur Aufhängung
 HU Acél kábel



OS-HERZW1-00

metal, metal, металл, Metall, fém

200 cm

19 g

5902801129551







PLAFONIERY I OPRAWY KANAŁOWE
CEILING FIXTURES & BULKHEAD FIXTURES
ЖКХ СВЕТИЛЬНИКИ
DECKEN- UND FEUCHTRAUM-/AUSSENLEUCHTEN
MENNYEZETI LÁMPÁK ÉS MÉLYSUGÁRZÓ LÁMPATESTEK

- PL Plafoniera z czujnikiem ruchu
- EN Ceiling fixture with motion sensor
- RU Светильник с датчиком движения
- DE Decken-/Wandleuchte mit Bewegungsmelder
- HU Mozgásérzékelővel felszerelt mennyezeti lámpa

PLCRKM

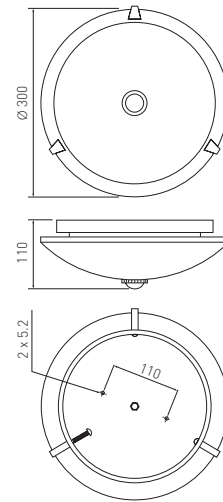

OS-PLCRKM-00	szkło - metal, glass - metal, стекло - металл, Glas - Metall, üveg - fém	mleczny, soft white, белый матовый, milchig, tejszínű	1320 g	5908231302885



- PL Plafoniera z mikrofalowym czujnikiem ruchu
- EN Ceiling fixture with microwave motion sensor
- RU Светильник с микроволновым датчиком движения
- DE Decken-/Wandleuchte mit Bewegungsmelder
- HU Mikrohullámú mozgásérzékelővel felszerelt mennyezeti lámpa

PLCZMI

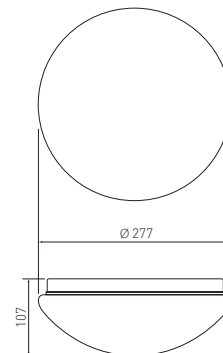

OS-PLCZMI-00	tworzywo, plastic, пластмасса, Kunststoff, anyag	mleczny, soft white, белый матовый, milchig, tejszínű	500 g	5908231336996



PL Plafoniera z czujnikiem ruchu
EN Ceiling fixture with motion sensor
RU Светильник с датчиком движения
DE Decken-/Wandleuchte mit Bewegungsmelder
HU Mozgásérzékelővel felszerelt mennyezeti lámpa

VIZELA

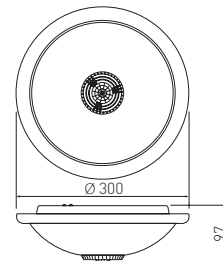

OS-PLCRKZ-00	szkło - metal, glass - metal, стекло - металл, Glas - Metall, üveg - fém	biały, white, белый, weiß, fehér	860 g	5908231339973
--------------	--	--	-------	---------------



PL Plafoniera
EN Ceiling fixture
RU Светодиодный светильник лестничный
DE Deckenleuchte
HU Mennyezeti lámpa

SILVER

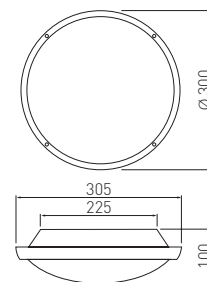

OS-PSL02E27-80	tworzywo sztuczne, plastic, пластмасса, Kunststoff, műanyag	szary; osłona mleczna, grey; soft white cover, серый; молочный рассеиватель, grau; milchige Abdeckung, szürke; tejszínű védőkupak	1300 g	5901867138835
----------------	---	---	--------	---------------



PL Plafoniera
EN Ceiling fixture
RU Светодиодный светильник
DE Deckenleuchte
HU Mennyezeti lámpa



SILVER-X

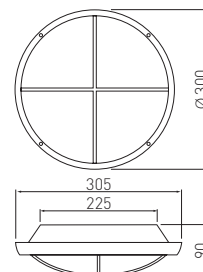

OS-PSLX2E27-80	tworzywo sztuczne, plastic, пластмасса, Kunststoff, műanyag	szary; osłona mleczna, grey; soft white cover, серый; молочный рассеиватель, grau; milchige Abdeckung, szürke; tejszínű védőkupak	1300 g	5901867138859



PL Plafoniera
EN Ceiling fixture
RU Светильник
DE Deckenleuchte
HU Mennyezeti lámpa

RINGO

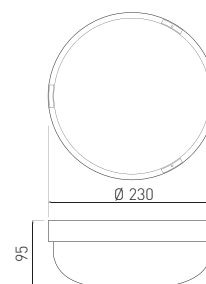

OS-RINGO1-00	korpus: ABS; klosz: szkło hartowane body: ABS; lens: tempered glass, корпус ABS, рассеиватель: закаленное стекло, Gehäuse: ABS; Schirm: Gehärtetes Glas test: ABS; lencse: hőkezelt üveg	biały, white, белый, weiß, fehér	900 g	5901867122896



Technical & industrial fixtures

PL Oprawa kanałowa
EN Bulkhead fixtures
RU ЖКХ Светильник
DE Robuste Wand-/Deckenleuchte
HU Mélysugárzó lámpatest

IBIZA

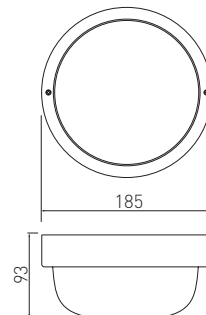

OS-IBBL060-00	korpus ABS; klosz szkło, body: ABS, lens: glass, корпус ABS, рассеиватель стекло, Gehäuse ABS; Schirm Glas, test ABS, lencse üveg	biały, white, белый, weiß, fehér	720 g	5908231338464
---------------	---	--	-------	---------------



PL Oprawa kanałowa
EN Bulkhead fixtures
RU ЖКХ Светильник
DE Robuste Wand-/Deckenleuchte
HU Mélysugárzó lámpatest

IBIZA

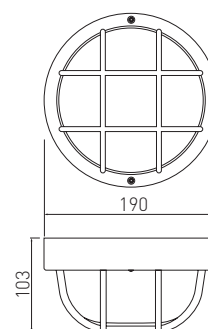

OS-IBKRO60-00	korpus: ABS; klosz: szkło, body: ABS, lens: glass, корпус ABS, рассеиватель: стекло, Gehäuse: ABS; Schirm: Glas, test: ABS, lencse: üveg	biały, white, белый, weiß, fehér	710 g	5908231338457
---------------	--	--	-------	---------------



- PL Oprawa kanałowa z czujnikiem ruchu
- EN Bulkhead fixture with motion sensor
- RU ЖКХ Светильник с датчиком движения
- DE Robuste Decken-/Wandleuchte mit Bewegungsmelder
- HU Mozgásérzékelővel felszerelt mélysugárzó lámpatest



KACROO

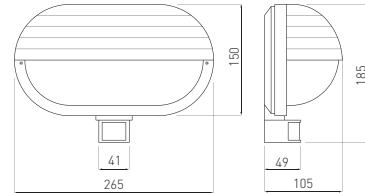

OS-KACROO-00	ABS, PC	biały, white, белый, weiß, fehér	580 g	5908231302151
--------------	---------	----------------------------------	-------	---------------



- PL Oprawa kanałowa z czujnikiem ruchu
- EN Bulkhead fixture with motion sensor
- RU ЖКХ Светильник с датчиком движения
- DE Robuste Decken-/Wandleuchte mit Bewegungsmelder
- HU Mozgásérzékelővel felszerelt mélysugárzó lámpatest

KACROO

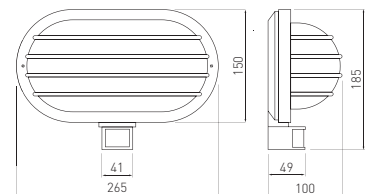

OS-KACRKR-00	ABS, PC,	biały, white, белый, weiß, fehér	530 g	5908231302168
--------------	----------	----------------------------------	-------	---------------



Technical & industrial fixtures



PL Oprawa kanałowa
EN Bulkhead fixtures
RU ЖКХ Светильник
DE Robuste Wand-/Deckenleuchte
HU Mélysugárzó lámpatest

SANGUESA – KAY

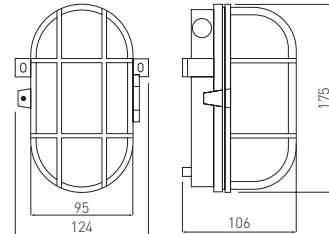

OS-KAY060-00	korpus: ABS; klosz: szkło, body: ABS, lens: glass, корпус ABS, рассеиватель: стекло, Gehäuse: ABS; Schirm: Glas, test: ABS, lencse: üveg	biały, white, белый, weiß, fehér	560 g	5908231302137
OS-KAY060-10		czarny, black, черный, schwarz, fekete		5908231302144



PL Oprawa kanałowa
EN Bulkhead fixtures
RU ЖКХ Светильник
DE Robuste Wand-/Deckenleuchte
HU Mélysugárzó lámpatest

SANGUESA – KAM

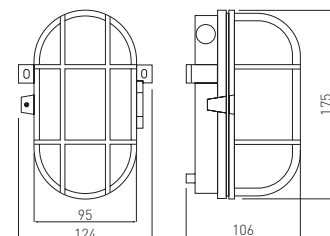

OS-KAM060-00	korpus: ABS; klosz: szkło, body: ABS, Lens: glass, корпус ABS, рассеиватель: стекло, Gehäuse: ABS; Schirm: Glas, test: ABS, lencse: üveg	biały, white белый, weiß, fehér	500 g	5908231394620
OS-KAM060-10		czarny, black черный, schwarz, fekete		5908231337795







OPRAWY WARSZTATOWE I LATARKI LED
WORKSHOP FIXTURES & LED FLASHLIGHTS
СВЕТИЛЬНИКИ ДЛЯ МАСТЕРСКОЙ И LED-ФОНАРИ
WERKSTATTLEUCHTEN UND LED-TASCHENLAMPEN
MENNYEZETI LÁMPÁK ÉS MÉLYSUGÁRZÓ LÁMPATESTEK

PL Oprawa przenośna
EN Portable fitting
RU Переносной светильник
DE Tragbare Leuchte
HU Hordozható lámpatest



OS-KAN527-24	60 W	tworzywo; metal, plastic; metal, пластик; металл, Kunststoff; Metall, műanyag; fém	550 g	5908231301307
--------------	------	--	-------	---------------



PL Oprawa przenośna z magnesem
EN Portable fitting with magnet
RU Переносной светильник с магнитом
DE Tragbare Leuchte mit Magnet
HU Hordozható mágneses lámpatest



OS-KAN527-24M	60 W	tworzywo; metal, plastic; metal, пластик; металл, Kunststoff; Metall, műanyag; fém	550 g	5901867122827
---------------	------	--	-------	---------------



Technical & industrial
fixtures



PL Oprawa przenośna świetlówkowa
 EN Portable fluorescent lamp fixture
 RU Переносной люминесцентный светильник
 DE Tragbare Leuchtstoffröhren-Lampe
 HU Fénycsöves mozgó lámpatest



OS-KAX527-10

tworzywo, plastic, пластмасса, Kunststoff, anyag

5908231301291



PL Oprawa przenośna
 EN Portable lamp fixture
 RU Переносной светильник
 DE Tragbare Lampe
 HU Fénycsöves mozgó lámpatest



OS-KAG508-10

tworzywo, plastic, пластмасса, Kunststoff, anyag

5908231301284



- PL Latarka LED
- EN LED Flashlight
- RU LED-фонарь
- DE LED-Taschenlampe
- HU LED Zseblámpa

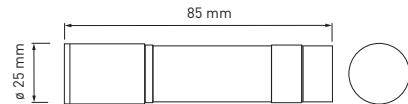

LT-LK3WBL-60	3 W	6400 K	150 lm	aluminium aluminium алюминий Aluminium aluminium	35 g	5902801260063



- PL Latarka LED
- EN LED Flashlight
- RU LED-фонарь
- DE LED-Taschenlampe
- HU LED Zseblámpa

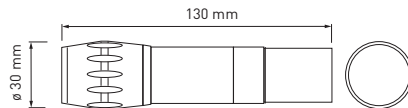

LT-LKSZ3W-60	5 W	6400 K	300 lm	aluminium aluminium алюминий Aluminium aluminium	130 g	5902801260124



Technical & industrial fixtures







OPRAWY DEKORACYJNE
DECORATIVE FIXTURES
ДЕКОРАТИВНЫЕ СВЕТИЛЬНИКИ
DEKORATIVE FASSUNGEN
DÍSZVILÁGÍTÁS



Oprawy schodowe Staircase fixtures Лестничные светильники Treppenhauseuchten Lépcsővilágítók	157.
Oprawy punktowe Spot light fixtures Точечные светильники Punktstrahler Spot-keretek	164.
Oprawy sufitowe Ceiling fixtures Потолочные светильники Deckenleuchten Plafonkeretek	184.
Oprawy ogrodowe i elewacyjne Garden and wall-mounted fixtures Садовые и фасадные светильники Garten- und Fassadenleuchten Kerti és homlokzati keretek	196.
Lampki Desk lamps Настольные лампы Schreibtischlampen Asztali lámpák	208.



OPRAWY SCHODOWE
STAIRCASE FIXTURES
ЛЕСТНИЧНЫЕ СВЕТИЛЬНИКИ
TREPPENHAUSLEUCHTEN
LEPCSŐVILAGITOK

PL Oprawy schodowe LED
EN Staircase LED fixtures
RU Лестничные светодиодные светильники
DE LED-Treppenleuchten
HU LED lépcsővilágítók

ESCADA

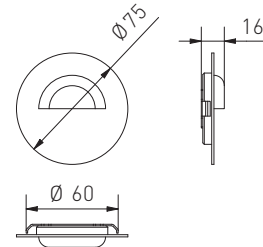

LD-ESOA084-51

0,8 W

● 4000 K

70 lm

inox

5902801211119



PL Oprawy schodowe LED
EN Staircase LED fixtures
RU Лестничные светодиодные светильники
DE LED-Treppenleuchten
HU LED lépcsővilágítók

ESCADA

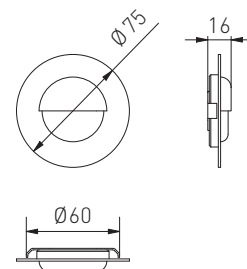

LD-ESOB084-51

0,8 W

● 4000 K

70 lm

inox

5902801210990



PL Oprawy schodowe LED
 EN Staircase LED fixtures
 RU Лестничные светодиодные светильники
 DE LED-Treppenleuchten
 HU LED lépcsővilágítók

ESCADA

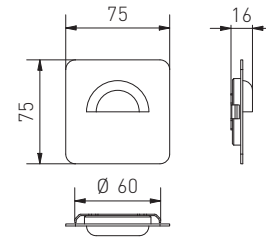

LD-ESKA084-51	0,8 W	● 4000 K	70 lm	inox	5902801211270

PL Oprawy schodowe LED
 EN Staircase LED fixtures
 RU Лестничные светодиодные светильники
 DE LED-Treppenleuchten
 HU LED lépcsővilágítók

ESCADA

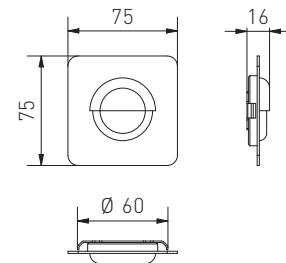

LD-ESKB084-51	0,8 W	● 4000 K	70 lm	inox	5902801211201

Decorative fixtures

PL Oprawy schodowe LED
EN Staircase LED fixtures
RU Лестничные светодиодные светильники
DE LED-Treppenleuchten
HU LED lépcsővilágítók

SILVER

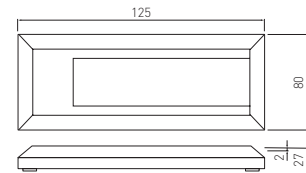

LD-OSSLPB1W-80	1 W	3000 K	45 lm	szary, grey, серый, grau, szürke	220 g	5901867138897
----------------	-----	--------	-------	--	-------	---------------



PL Oprawy schodowe LED
EN Staircase LED fixtures
RU Лестничные светодиодные светильники
DE LED-Treppenleuchten
HU LED lépcsővilágítók

SILVER

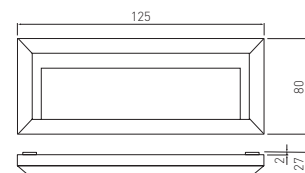

LD-OSSLPB2W-80	2 W	3000 K	100 lm	szary, grey, серый, grau, szürke	220 g	5901867138873
----------------	-----	--------	--------	--	-------	---------------



PL Oprawy schodowe LED
EN Staircase LED fixtures
RU Лестничные светодиодные светильники
DE LED-Treppenleuchten
HU LED lépcsővilágítók

SILVER

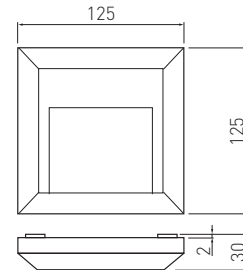

LD-OSSLKD2W-80	2 W	3000 K	100 lm	szary, grey, серый, grau, szürke	180 g	5901867138927

PL Oprawy schodowe LED
EN Staircase LED fixtures
RU Лестничные светодиодные светильники
DE LED-Treppenleuchten
HU LED lépcsővilágítók

SILVER

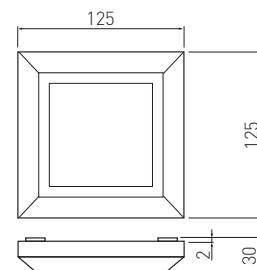

LD-OSSLKW4W-80	4 W	3000 K	250 lm	szary, grey, серый, grau, szürke	180 g	5901867138903



PL Oprawy schodowe LED
EN Staircase LED fixtures
RU Лестничные светодиодные светильники
DE LED-Treppenleuchten
HU LED lépcsővilágítók

SILVER

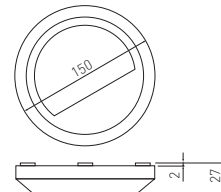
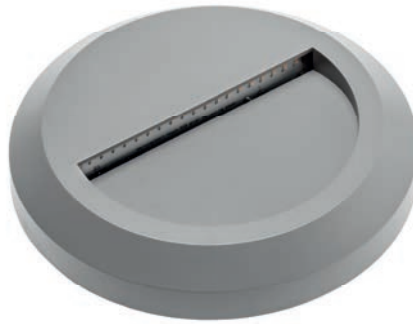

LD-OSSLOD2W-80	2 W	3000 K	100 lm	szary, grey, серый, grau, szürke	200 g	5901867138965
----------------	-----	--------	--------	--	-------	---------------



PL Oprawy schodowe LED
EN Staircase LED fixtures
RU Лестничные светодиодные светильники
DE LED-Treppenleuchten
HU LED lépcsővilágítók

SILVER

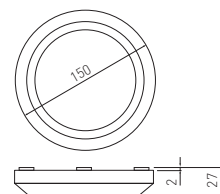

LD-OSSLOW3W-80	3 W	3000 K	200 lm	szary, grey, серый, grau, szürke	200 g	5901867138941
----------------	-----	--------	--------	--	-------	---------------







OPRAWY PUNKTOWE
SPOT LIGHT FIXTURES
ТОЧЕЧНЫЕ СВЕТИЛЬНИКИ
PUNKTSTRAHLER
SPOT-KERETEK

PL Sufitowa oprawa punktowa
 EN Ceiling spot light fixture
 RU Потолочный точечный светильник
 DE Decken-Punktleuchte
 HU Mennyezeti spot lámpatest

PARMA

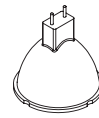

MR16

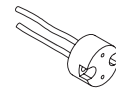

GZ-MR16-0000

Powiązane produkty:
 Related products:
 Связанных с ними продуктов:
 Verwandte Produkte:
 Kapcsolodo termekek:



OP-PAST1-01	stal steel сталь Stahl acél	chrom, chrome, хром, Chrom, króm	40 g	5908231384195
OP-PAST1-02		inox, inox, inox, Inox, inox		5908231384232
OP-PAST1-10		biały, white, белый, weiß, fehér		5908231384171
OP-PAST1-21		czarny chrom, black chrome, черный хром, schwarz Chrom, fekete króm		5908231384188
OP-PAST1-30		patyna, weathered, патина, Patina, patina		5908231384201

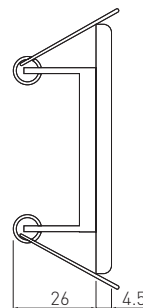
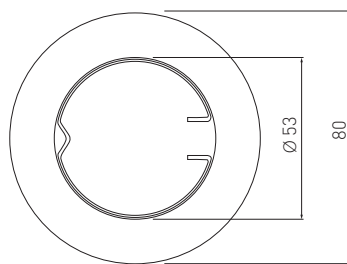

PL Sufitowa oprawa punktowa
 EN Ceiling spot light fixture
 RU Потолочный точечный светильник
 DE Decken-Punktleuchte
 HU Mennyezeti spot lámpatest

PARMA



OP-PAST2-01

OP-PAST2-02

OP-PAST2-10



OP-PAST2-21



OP-PAST2-30

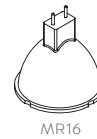

MR16

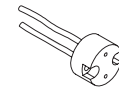

GZ-MR16-0000

Powiązane produkty:
 Related products:
 Связанных с ними продуктов:
 Verwandte Produkte:
 Kapcsolodo termek:



OP-PAST2-01	stal steel сталь Stahl acél	chrom, chrome, хром, Chrom, króm	50 g	5901867101594
OP-PAST2-02		inox, inox, inox, Inox, inox		5901867101587
OP-PAST2-10		biały, white, белый, weiß, fehér		5901867101693
OP-PAST2-21		czarny chrom, black chrome, черный хром, schwarz Chrom, fekete króm		5901867101600
OP-PAST2-30		patyna, weathered, патина, Patina, patina		5901867101570

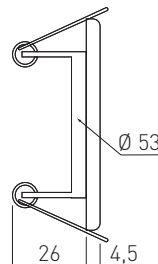
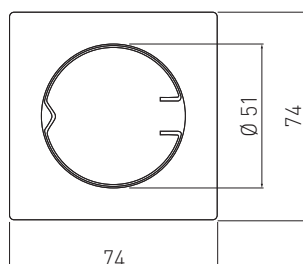

PL Sufitowa oprawa punktowa
 EN Ceiling spot light fixture
 RU Потолочный точечный светильник
 DE Decken-Punktleuchte
 HU Mennyezeti spot lámpatest

PARMA II



OP-PADST1-10



OP-PADST1-01



OP-PADST1-52



OP-PADST1-61



OP-PADST1-21

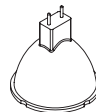

MR16

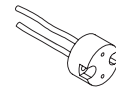

GZ-MR16-0000

Powiązane produkty:
 Related products:
 Связанных с ними продуктов:
 Verwandte Produkte:
 Kapcsolodo termek:



OP-PADST1-10	stal steel сталь Stahl acél	biały, white, белый, weiß, fehér	35 g	5908231384195
OP-PADST1-01		chrom, chrome, хром, Chrom, króm		5908231384232
OP-PADST1-52		satyna, satin, сатин, Nickel matt, Szatén,		5908231384171
OP-PADST1-61		stare złoto, antique gold, старое золото, Altgold, Régi arany		5908231384188
OP-PADST1-21		czarny chrom, black chrome, черный хром, schwarz Chrom, fekete króm		5908231384201

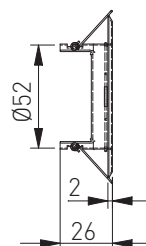
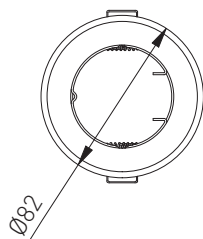

PL Sufitowa oprawa punktowa
 EN Ceiling spot light fixture
 RU Потолочный точечный светильник
 DE Decken-Punktleuchte
 HU Mennyezeti spot lámpatest

PARMA II



OP-PADRK1-10



OP-PADRK1-01



OP-PADRK1-52



OP-PADRK1-61



OP-PADRK1-21

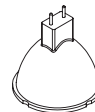

MR16

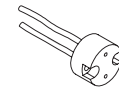

GZ-MR16-0000

Powiązane produkty:
 Related products:
 Связанных с ними продуктов:
 Verwandte Produkte:
 Kapcsolodo termek:



OP-PADRK1-10	stal steel сталь Stahl acél	biały, white, белый, weiß, fehér	60 g	5908231384195
OP-PADRK1-01		chrom, chrome, хром, Chrom, króm		5908231384232
OP-PADRK1-52		satyna, satin, сатин, Nickel matt, Szatén,		5908231384171
OP-PADRK1-61		stare złoto, antique gold, старое золото, Altgold, Régi arany		5908231384188
OP-PADRK1-21		czarny chrom, black chrome, черный хром, schwarz Chrom, fekete króm		5908231384201

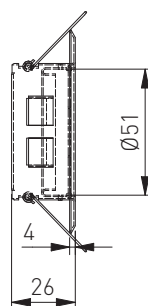
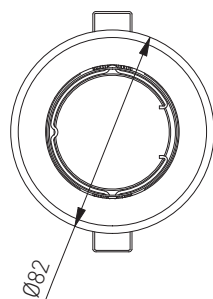

PL Sufitowa oprawa punktowa
 EN Ceiling spot light fixture
 RU Потолочный точечный светильник
 DE Decken-Punktleuchte
 HU Mennyezeti spot lámpatest

PORTO

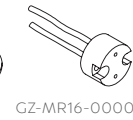
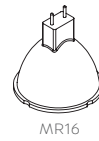

Powiązane produkty:
 Related products:
 Связанных с ними продуктов:
 Verwandte Produkte:
 Kapcsolodo termekek:



OP-PROD3-01	aluminium aluminium алюминий Aluminium aluminium	chrom, chrome, хром, Chrom, króm	40 g	5908231384225
OP-PROD3-02		inox, inox, inox, Inox, inox		5908231384249
OP-PROD3-21		czarny chrom, black chrome, черный хром, schwarz Chrom, fekete króm		5908231384256
OP-PROD3-30		patyna, weathered, патина, Patina, patina		5908231384263

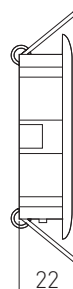
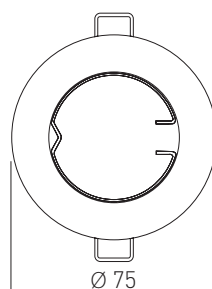

PL Sufitowa oprawa punktowa
 EN Ceiling spot light fixture
 RU Потолочный точечный светильник
 DE Decken-Punktleuchte
 HU Mennyezeti spot lámpatest

PORTO



Decorative fixtures

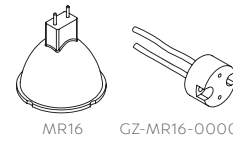

Powiązane produkty:
 Related products:
 Связанных с ними продуктов:
 Verwandte Produkte:
 Kapcsolodo termek:

Model	Material	Finish	Weight	Barcode
OP-PROD4-01	aluminium aluminium алюминий Aluminium aluminium	chrom, chrome, хром, Chrom, króm	50 g	5901867101617
OP-PROD4-02		inox, inox, inox, Inox, inox		5901867101631
OP-PROD4-21		czarny chrom, black chrome, черный хром, schwarz Chrom, fekete króm		5901867101624
OP-PROD4-30		patyna, weathered, патина, Patina, patina		5901867101648

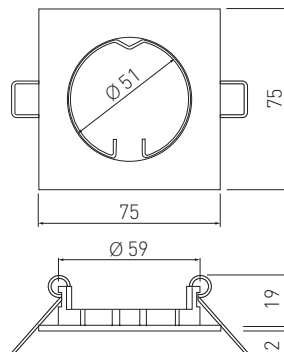

PL Sufitowa oprawa punktowa uchylna
 EN Directional ceiling spot light fixture
 RU Потолочный точечный светильник с изменением наклона
 DE Decken-Punktleuchte schwenkbar
 HU Mennyezeti spot bukó lámpatest

PORTO K

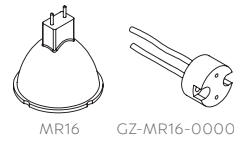

Powiązane produkty:
 Related products:
 Связанных с ними продуктов:
 Verwandte Produkte:
 Kapcsolodo termek:

OP-PRAN5-01	aluminium aluminium алюминий Aluminium alumínium	chrom, chrome, хром, Chrom, króm	80 g	5908231384270
OP-PRAN5-02		inox, inox, inox, Inox, inox		5908231384287
OP-PRAN5-21		czarny chrom, black chrome, черный хром, schwarz Chrom, fekete króm		5908231384294
OP-PRAN5-30		patyna, weathered, патина, Patina, patina		5908231384300

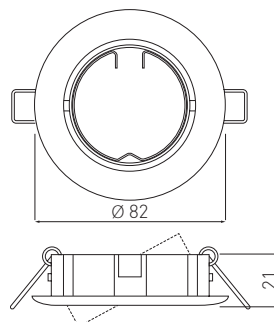

PL Sufitowa oprawa punktowa uchylna
 EN Directional ceiling spot light fixture
 RU Потолочный точечный светильник с изменением наклона
 DE Decken-Punktleuchte schwenkbar
 HU Mennyezeti spot bukó lámpatest

PORTO K

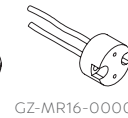
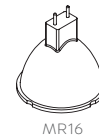

Powiązane produkty:
 Related products:
 Связанных с ними продуктов:
 Verwandte Produkte:
 Kapcsolodo termek:



OP-PRAN6-01	aluminium aluminium алюминий Aluminium aluminium	chrom, chrome, хром, Chrom, króm	60 g	5901867101655
OP-PRAN6-02		inox, inox, inox, Inox, inox		5901867101686
OP-PRAN6-21		czarny chrom, black chrome, черный хром, schwarz Chrom, fekete króm		5901867101679
OP-PRAN6-30		patyna, weathered, патина, Patina, patina		5901867101662

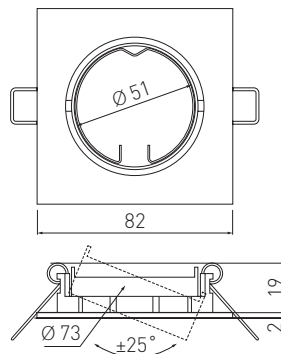

PL Sufitowa oprawa punktowa uchylna
 EN Directional ceiling spot light fixture
 RU Потолочный точечный светильник с изменением наклона
 DE Decken-Punktleuchte schwenkbar
 HU Mennyezeti spot bukó lámpatest

VILA

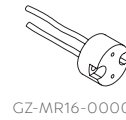
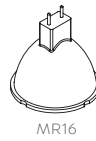

Powiązane produkty:
 Related products:
 Связанных с ними продуктов:
 Verwandte Produkte:
 Kapcsolodo termek:

Icon: Folder	Icon: Cubes	Icon: Leaf	Icon: Bolt	Icon: Barcode
OP-VILAKW-01	stal, steel, сталь, Stahl, acél	chrom, chrome, хром, Chrom, króm	100 g	5901867127518
OP-VILAKW-02		inox, inox, inox, Inox, inox		5901867127532
OP-VILAKW-10		biały, white, белый, weiß, fehér		5901867127570
OP-VILAKW-30		patyna, weathered, патина, Patina, patina		5901867127556

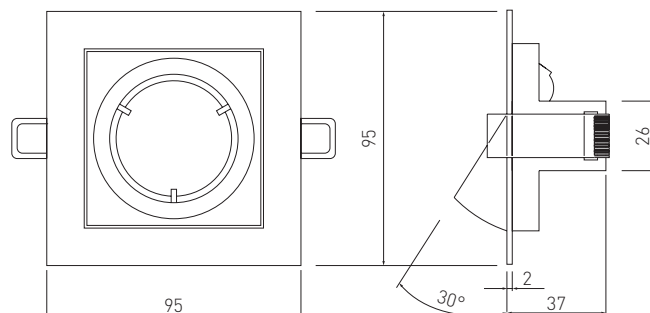



PL Sufitowa oprawa punktowa
EN Ceiling spot light fixture
RU Потолочный точечный светильник
DE Decken-Punktleuchte
HU Mennyezeti spot lámpatest

MAREA



Inox

White

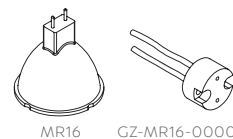

MR16 GZ-MR16-0000

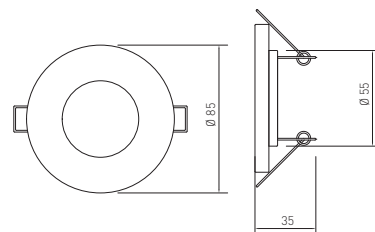

OP-MAROK-02	metal, metal, металл, Metall, fém	inox, inox, inox, Inox, inox	95 g	5901867197603
OP-MAROK-10		biały, white, белый, weiß, fehér		5901867197597



PL Sufitowa oprawa punktowa
EN Ceiling spot light fixture
RU Потолочный точечный светильник
DE Decken-Punktleuchte
HU Mennyezeti spot lámpatest

BRILLANTE



Black

White

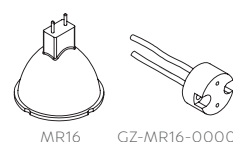

MR16 GZ-MR16-0000

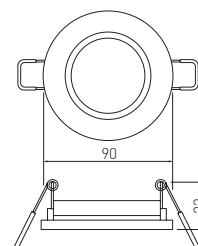

OP-OPROKR-10	szkło, glass, стекло, Glas, üveg	biały, white, белый, weiß, fehér	130 g	5901867109699
OP-OPROKR-21		czarny, black, черный, schwarz, fekete		5901867109705





PL Sufitowa oprawa punktowa
EN Ceiling spot light fixture
RU Потолочный точечный светильник
DE Decken-Punktleuchte
HU Mennyezeti spot lámpatest

BRILLANTE



Black

White

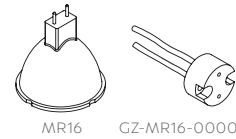

MR16 GZ-MR16-0000

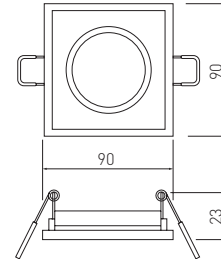

OP-OPRKWT-10	szkło, glass, стекло, Glas, üveg	biały, white, белый, weiß, fehér	130 g	5901867109675
OP-OPRKWT-21		czarny, black, черный, schwarz, fekete		5901867109682



PL Sufitowa oprawa punktowa
EN Ceiling spot light fixture
RU Потолочный точечный светильник
DE Decken-Punktleuchte
HU Mennyezeti spot lámpatest

BRILLANTE



Black

White

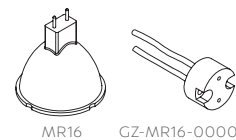

MR16 GZ-MR16-0000

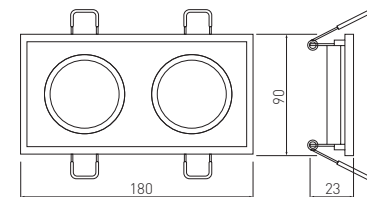

OP-DUOKWT-10	szkło, glass, стекло, Glas, üveg	biały, white, белый, weiß, fehér	300 g	5901867110329
OP-DUOKWT-21		czarny, black, черный, schwarz, fekete		5901867110336



Decorative fixtures



Powiązane produkty:
Related products:
Связанных с ними продуктов:
Verwandte Produkte:
Kapcsolodo termek:



PL Sufitowa oprawa punktowa uchylna
 EN Directional ceiling spot light fixture
 RU Потолочный точечный светильник с изменением наклона
 DE Decken-Punktleuchte schwenkbar
 HU Mennyezeti spot bukó lámpatest

Powiązane produkty:
 Related products:
 Связанных с ними продуктов:
 Verwandte Produkte:
 Kapcsolodo termek:

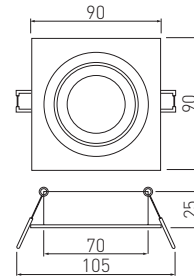
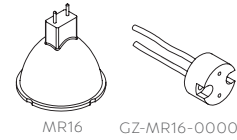

Black

Silver



OP-OPRKW1-20	aluminium, aluminium, алюминий, Aluminium, aluminium	czarny, black, черный, schwarz, fekete	50 g	5901867127853
OP-OPRKW1-80		srebrny, silver, серебряный, silber, ezüst		5901867127839



Decorative fixtures



PL Sufitowa oprawa punktowa uchylna
 EN Directional ceiling spot light fixture
 RU Потолочный точечный светильник с изменением наклона
 DE Decken-Punktleuchte schwenkbar
 HU Mennyezeti spot bukó lámpatest

Powiązane produkty:
 Related products:
 Связанных с ними продуктов:
 Verwandte Produkte:
 Kapcsolodo termek:

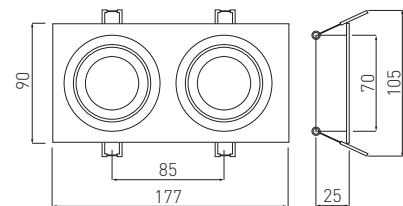
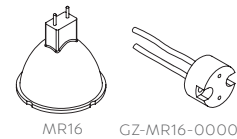

Black

Silver



OP-OPRKW2-20	aluminium, aluminium, алюминий, Aluminium, aluminium	czarny, black, черный, schwarz, fekete	100 g	5901867127938
OP-OPRKW2-80		srebrny, silver, серебряный, silber, ezüst		5901867127914







PL Sufitowa oprawa punktowa uchylna
 EN Directional ceiling spot light fixture
 RU Потолочный точечный светильник с изменением наклона
 DE Decken-Punktleuchte schwenkbar
 HU Mennyezeti spot bukó lámpatest

Powiązane produkty:
 Related products:
 Связанных с ними продуктов:
 Verwandte Produkte:
 Kapcsolodo termekek:

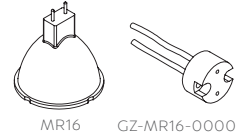

MORENA



Black

Silver

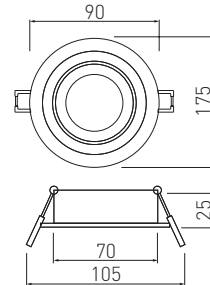

OP-OPROK1-20	aluminium, aluminium, алюминий, Aluminium, alumínium	czarny, black, черный, schwarz, fekete	50 g	5901867127815
OP-OPROK1-80		srebrny, silver, серебряный, Silber, ezüst		5901867127792



PL Sufitowa oprawa punktowa uchylna
 EN Directional ceiling spot light fixture
 RU Потолочный точечный светильник с изменением наклона
 DE Decken-Punktleuchte schwenkbar
 HU Mennyezeti spot bukó lámpatest

Powiązane produkty:
 Related products:
 Связанных с ними продуктов:
 Verwandte Produkte:
 Kapcsolodo termekek:

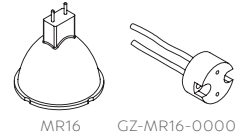

MORENA



Black

Silver

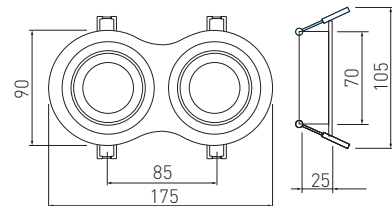

OP-OPROK2-20	aluminium, aluminium, алюминий, Aluminium, alumínium	czarny, black, черный, schwarz, fekete	100 g	5901867127891
OP-OPROK2-80		srebrny, silver, серебряный, Silber, ezüst		5901867127877





PL Sufitowa oprawa punktowa
EN Ceiling spot light fixture
RU Потолочный точечный светильник
DE Decken-Punktleuchte
HU Mennyezeti spot lámpatest

Powiązane produkty:
Related products:
Связанных с ними продуктов:
Verwandte Produkte:
Kapcsolodo termekek:

PALACE



OP-PALACEOK-10



OP-PALACEOK-20

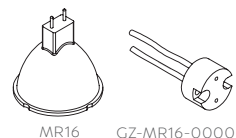

MR16 GZ-MR16-0000

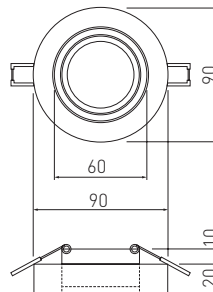

OP-PALACEOK-10	szkło, glass, стекло, Glas, üveg	biały, white, белый, weiß, fehér	210 g	5901867128034
OP-PALACEOK-20		czarny, black, черный, schwarz, fekete		5901867128058



PL Sufitowa oprawa punktowa
EN Ceiling spot light fixture
RU Потолочный точечный светильник
DE Decken-Punktleuchte
HU Mennyezeti spot lámpatest

PALACE



OP-PALACEKW-10

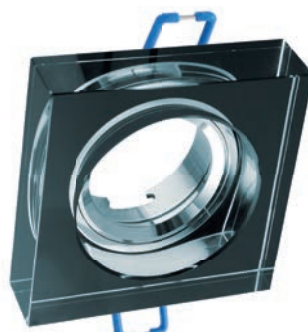

OP-PALACEKW-20

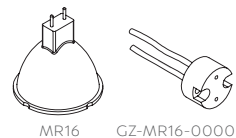

MR16 GZ-MR16-0000

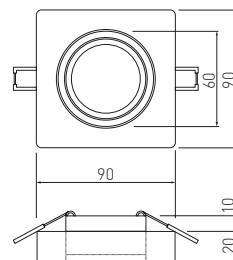

OP-PALACEKW-10	szkło, glass, стекло, Glas, üveg	biały, white, белый, weiß, fehér	210 g	5901867128072
OP-PALACEKW-20		czarny, black, черный, schwarz, fekete		5901867128096



Powiązane produkty:
Related products:
Связанных с ними продуктов:
Verwandte Produkte:
Kapcsolodo termekek:



PL Sufitowa oprawa punktowa
EN Ceiling spot light fixture
RU Потолочный точечный светильник
DE Decken-Punktleuchte
HU Mennyezeti spot lámpatest

Powiązane produkty:
Related products:
Связанных с ними продуктов:
Verwandte Produkte:
Kapcsolodo termekek:

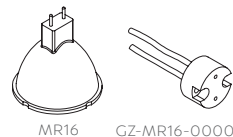

MR16 GZ-MR16-0000

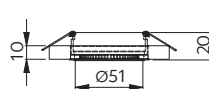
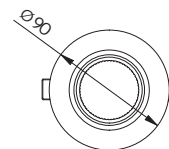

PALACE II

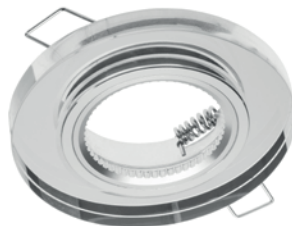

Black

White



OP-PALACEDOK-10	szkło, glass, стекло, Glas, üveg	biały, white, белый, weiß, fehér	125 g	5902801130038
OP-PALACEDOK-20		czarny, black, черный, schwarz, fekete		5902801130083



Decorative fixtures



PL Sufitowa oprawa punktowa
EN Ceiling spot light fixture
RU Потолочный точечный светильник
DE Decken-Punktleuchte
HU Mennyezeti spot lámpatest

Powiązane produkty:
Related products:
Связанных с ними продуктов:
Verwandte Produkte:
Kapcsolodo termekek:

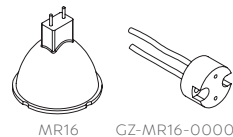

MR16 GZ-MR16-0000

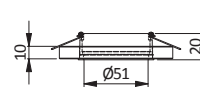
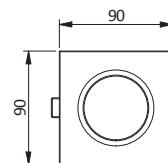

PALACE II

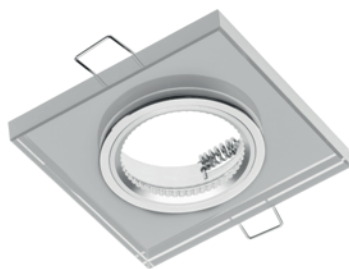

Black

White



OP-PALACEDKW-10	szkło, glass, стекло, Glas, üveg	biały, white, белый, weiß, fehér	165 g	5902801130052
OP-PALACEDKW-20		czarny, black, черный, schwarz, fekete		5902801130069





PL Sufitowa oprawa punktowa
EN Ceiling spot light fixture
RU Потолочный точечный светильник
DE Decken-Punktleuchte
HU Mennyezeti spot lámpatest

Powiązane produkty:
Related products:
Связанных с ними продуктов:
Verwandte Produkte:
Kapsolodo termek:

AURORA



OP-AUROKB-10



OP-AUROKS-52



OP-AUROKC-00

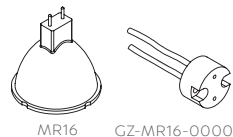

MR16 GZ-MR16-0000

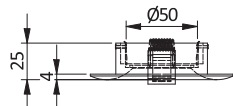
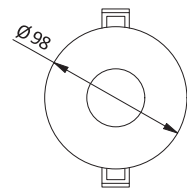

OP-AUROKB-10	aluminium, aluminium, алюминий, Aluminium, aluminium	biały, white, белый, weiß, fehér	100 g	5902801238819
OP-AUROKS-52		satyna, satin, сатин, Nickel matt, Szatén		5902801239731
OP-AUROKC-00		czarny, black, черный, schwarz, fekete		5902801267895



PL Sufitowa oprawa punktowa
EN Ceiling spot light fixture
RU Потолочный точечный светильник
DE Decken-Punktleuchte
HU Mennyezeti spot lámpatest

Powiązane produkty:
Related products:
Связанных с ними продуктов:
Verwandte Produkte:
Kapsolodo termek:

AURORA



OP-AURKWB-10



OP-AURKWS-52



OP-AURKWC-00

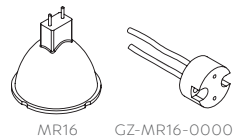

MR16 GZ-MR16-0000

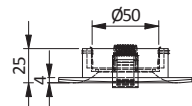
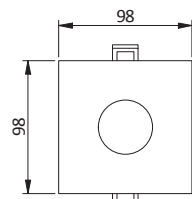

OP-AURKWB-10	aluminium, aluminium, алюминий, Aluminium, aluminium	biały, white, белый, weiß, fehér	130 g	5902801239991
OP-AURKWS-52		satyna, satin, сатин, Nickel matt, Szatén		5902801240034
OP-AURKWC-00		czarny, black, черный, schwarz, fekete		5902801267901





PL Sufitowa oprawa punktowa uchylna
 EN Directional ceiling spot light fixture
 RU Потолочный точечный светильник с изменением наклона
 DE Decken-Punktleuchte schwenkbar
 HU Mennyezeti spot bukó lámpatest

Powiązane produkty:
 Related products:
 Связанных с ними продуктов:
 Verwandte Produkte:
 Kapcsolodo termek:

SALTO

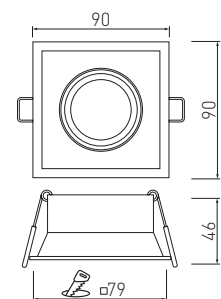
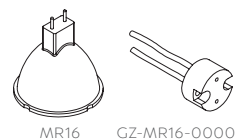

OP-SALKW-10	aluminium, aluminium, алюминий, Aluminium, alumínium	biały, white, белый, weiß, fehér	98 g	5901867197580
-------------	---	----------------------------------	------	---------------



PL Sufitowa oprawa punktowa uchylna
 EN Directional ceiling spot light fixture
 RU Потолочный точечный светильник с изменением наклона
 DE Decken-Punktleuchte schwenkbar
 HU Mennyezeti spot bukó lámpatest

Powiązane produkty:
 Related products:
 Связанных с ними продуктов:
 Verwandte Produkte:
 Kapcsolodo termek:

SALTO

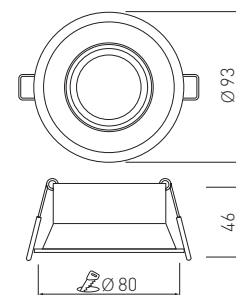
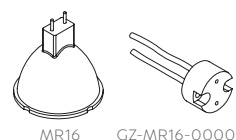

OP-SALOK-10	aluminium, aluminium, алюминий, Aluminium, alumínium	biały, white, белый, weiß, fehér	98 g	5901867197573
-------------	---	----------------------------------	------	---------------



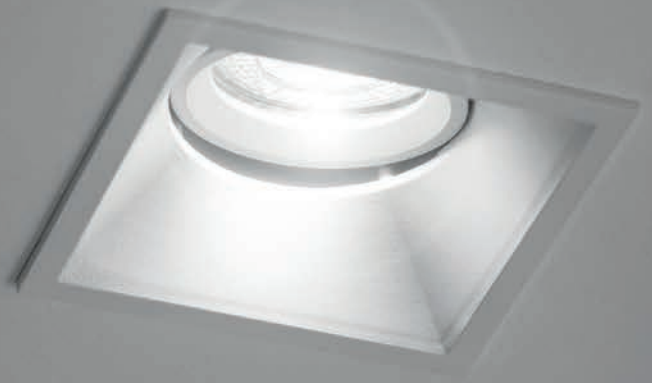



OPRAWY SUFITOWE
CEILING FIXTURES
ПОТОЛОЧНЫЕ СВЕТИЛЬНИКИ
DECKENLEUCHTEN
PLAFONKERETEK



PL Oprawa sufitowa
EN Ceiling light fitting
RU Плафониера
DE Deckenleuchte
HU Mennyezeti lámpatest

Powiązane produkty:
Related products:
Связанных с ними продуктов:
Verwandte Produkte:
Kapcsolodo termekek:

SENSA mini



Black

White

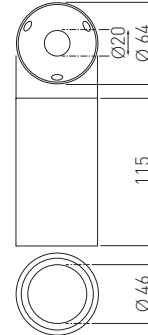
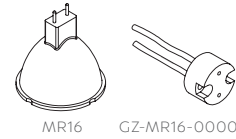

OS-SENM5081OKCZ-00	aluminium aluminium алюминий	czarny, black, черный, schwarz, fekete	5901867176769
OS-SENM5081OKB-10	Aluminium aluminium	biały, white, белый, weiß, fehér	5901867176752



PL Oprawa sufitowa
EN Ceiling light fitting
RU Плафониера
DE Deckenleuchte
HU Mennyezeti lámpatest

Powiązane produkty:
Related products:
Связанных с ними продуктов:
Verwandte Produkte:
Kapcsolodo termekek:

SENSA mini



Black

White

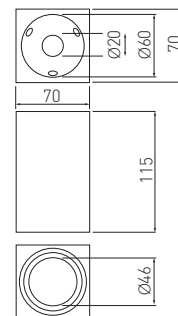
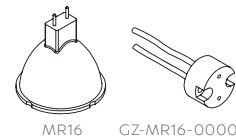

OS-SENM5091KWB-10	aluminium aluminium алюминий	biały, white, белый, weiß, fehér	5901867176837
OS-SENM5091KWCZ-00	Aluminium aluminium	czarny, black, черный, schwarz, fekete	5901867176851





PL Oprawa sufitowa
EN Ceiling light fitting
RU Плафониера
DE Deckenleuchte
HU Mennyezeti lámpatest

SENSA



Black

White

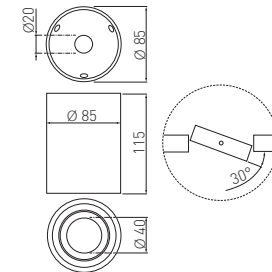
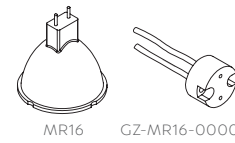

Powiązane produkty:
Related products:
Связанных с ними продуктов:
Verwandte Produkte:
Kapcsolodo termek:



OS-SEN5087OKCZ-00	aluminium aluminium алюминий Aluminium aluminium	czarny, black, черный, schwarz, fekete	5901867176813
OS-SEN5087OKB-10		biały, white, белый, weiß, fehér	5901867176776



Decorative fixtures

PL Oprawa sufitowa
EN Ceiling light fitting
RU Плафониера
DE Deckenleuchte
HU Mennyezeti lámpatest

SENSA



Black

White

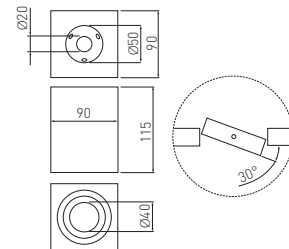
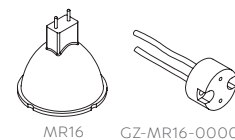

Powiązane produkty:
Related products:
Связанных с ними продуктов:
Verwandte Produkte:
Kapcsolodo termek:



OS-SEN5097KWB-10	aluminium aluminium алюминий Aluminium aluminium	biały, white, белый, weiß, fehér	5901867176875
OS-SEN5097KWCZ-00		czarny, black, черный, schwarz, fekete	5901867176899





PL Oprawa sufitowa
EN Ceiling light fitting
RU Плафониера
DE Deckenleuchte
HU Mennyezeti lámpatest

SENSO DUO



Black

White

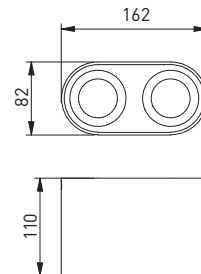

OS-SEND5083OKB-10	aluminium aluminium алюминий Aluminium aluminium	biały, white, белый, weiß, fehér	720 g	5902801129971
OS-SEND5083OKCZ-00		czarny, black, черный, schwarz, fekete		5902801129933



PL Zawieszka SENSEA
EN Hanger SENSEA
RU Подвес для профиля SENSEA
DE Aufhänger SENSEA
HU Fügő akasztó SENSEA



OP-SENZWOKB-10	OS-SEN5087OKB-10 OS-SEN5087OKCZ-00 OS-SEN5097KWB-10 OS-SEN5097KWZ-00	1,5 m	biały, white, белый, weiß, fehér	aluminium aluminium алюминий Aluminium aluminium	250 g	5902801000454
OP-SENZWOKCZ-00			czarny, black, черный, schwarz, fekete			5902801000447





PL Oprawa sufitowa
 EN Ceiling light fitting
 RU Плафониера
 DE Deckenleuchte
 HU Mennyezeti lámpatest

BLINK



Black

White

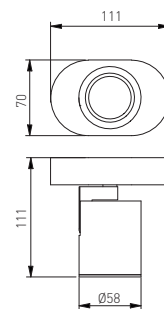

Icon: Folder	Icon: Cubes	Icon: Leaf	Icon: Bottle	Icon: Barcode
OS-BLN50W1-10	aluminium aluminium алюминий Aluminium aluminium	biały, white, белый, weiß, fehér	250 g	5902801240256
OS-BLN50W1-00		czarny, black, черный, schwarz, fekete		5902801240065



PL Oprawa sufitowa
EN Ceiling light fitting
RU Плафониера
DE Deckenleuchte
HU Mennyezeti lámpatest

BLINK



Black

White

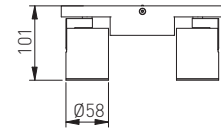
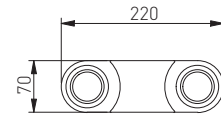

OS-BLN50W2-10	aluminium aluminium алюминий Aluminium aluminium	biały, white, белый, weiß, fehér	490 g	5902801240096
OS-BLN50W2-00		czarny, black, черный, schwarz, fekete		5902801240263



PL Oprawa sufitowa
EN Ceiling light fitting
RU Плафониера
DE Deckenleuchte
HU Mennyezeti lámpatest

BLINK



Black

White

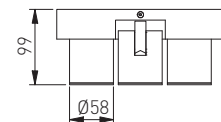
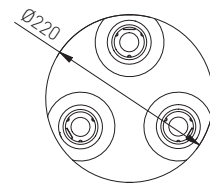

OS-BLN50W3-10	aluminium aluminium алюминий Aluminium aluminium	biały, white, белый, weiß, fehér	920 g	5902801242274
OS-BLN50W3-00		czarny, black, черный, schwarz, fekete		5902801241888





PL Sufitowa oprawa natynkowa
EN Surface ceiling fixture
RU Накладной светильник
DE Decken-Aufputzleuchte
HU Mennyezeti vakolat alatti lámpatest

PIREO N



Black

White

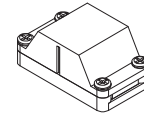
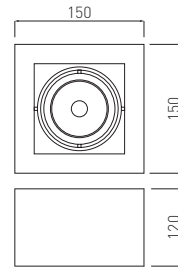

Akcesoria,
Accessories,
Аксессуары,
Zubehör,
Tartozékok:
LZ-KOI2KO-10



AR111

Powiązane produkty:
Related products:
Связанных с ними продуктов:
Verwandte Produkte:
Kapcsolódó termékek:



OP-PIREN1-00	stal steel сталь	biały, white, белый, weiß, fehér	500 g	5902801248412
OP-PIREN1-20	Stahl acél	czarny, black, черный, schwarz, fekete		5901867191151



PL Sufitowa oprawa natynkowa
EN Surface ceiling fixture
RU Накладной светильник
DE Decken-Aufputzleuchte
HU Mennyezeti vakolat alatti lámpatest

PIREO N



Black

White

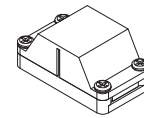
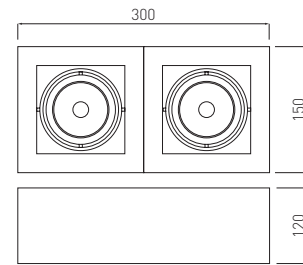

Akcesoria,
Accessories,
Аксессуары,
Zubehör,
Tartozékok:
LZ-KOI2KO-10

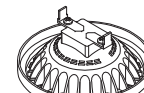

AR111

Powiązane produkty:
Related products:
Связанных с ними продуктов:
Verwandte Produkte:
Kapcsolódó termékek:



OP-PIREN2-00	stal steel сталь	biały, white, белый, weiß, fehér	900 g	5902801248535
OP-PIREN2-20	Stahl acél	czarny, black, черный, schwarz, fekete		5901867191151



PL Sufitowa oprawa podtynkowa
EN Recessed ceiling fixture
RU Потолочный светильник для скрытой установки
DE Decken-Unterputzleuchte
HU Mennyezeti vakolat alatti lámpatest

PIREO

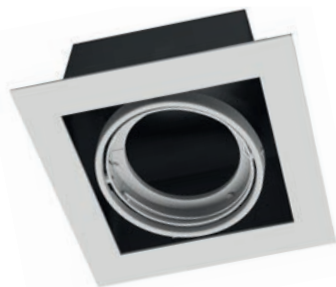

Black

Grey

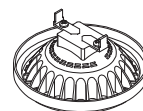
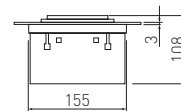
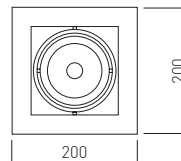

AR111

Powiązane produkty:
Related products:
Связанных с ними продуктов:
Verwandte Produkte:
Kapcsolódó termékek:



OP-PIREO1-20	stal steel сталь Stahl acél	czarny, black, черный, schwarz, fekete	500 g	5901867128287
OP-PIREO1-81		szary, grey, серый, grau, szürke		5901867128386



PL Sufitowa oprawa podtynkowa
EN Recessed ceiling fixture
RU Потолочный светильник для скрытой установки
DE Decken-Unterputzleuchte
HU Mennyezeti vakolat alatti lámpatest

PIREO



Black

Grey

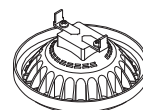
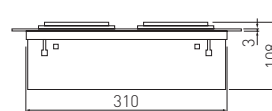
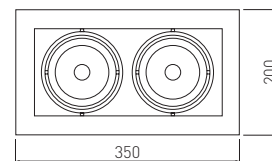

AR111

Powiązane produkty:
Related products:
Связанных с ними продуктов:
Verwandte Produkte:
Kapcsolódó termékek:



OP-PIREO2-20	stal steel сталь Stahl acél	czarny, black, черный, schwarz, fekete	920 g	5901867128300
OP-PIREO2-81		szary, grey, серый, grau, szürke		5901867128409



PL Sufitowa oprawa podtynkowa
EN Recessed ceiling fixture
RU Потолочный светильник для скрытой установки
DE Decken-Unterputzleuchte
HU Mennyezeti vakolat alatti lámpatest

PIREO



Black

Grey

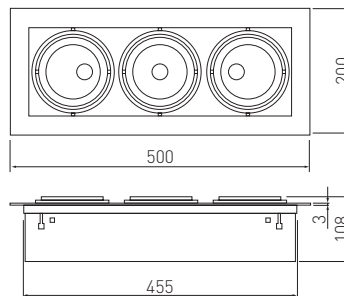

AR111

Powiązane produkty:
Related products:
Связанных с ними продуктов:
Verwandte Produkte:
Kapcsolódó termékek:

Decorative fixtures

OP-PIREO3-20	stal steel сталь	czarny, black, черный, schwarz, fekete	1200 g	5901867128324
OP-PIREO3-81	Stahl acél	szary, grey, серый, grau, szürke		5901867128423



PL Lampa wisząca
EN Pendant lamp
RU Висящая лампа
DE Hängeleuchte
HU Fűgőlámpa

MINIO



OS-MINIOE27-20

Black

Green

White

Red

Blue

Grey

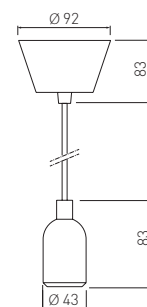

OS-MINIOE27-10	PC, silikon PC, silicone PC, силикон PC, Silikon PC, szilikon	biały, white, белый, weiß, fehér	110 g	5901867190710
OS-MINIOE27-20		czarny, black, черный, schwarz, fekete		5901867190673
OS-MINIOE27-40		niebieski, blue, синий, blau, kék		5901867190734
OS-MINIOE27-41		zielony, green, зеленый, grün, zöld		5901867190772
OS-MINIOE27-42		czerwony, red, красный, rot, piros		5901867190758
OS-MINIOE27-80		szary, grey, серый, grau, szürke		5901867190697







OPRAWY OGRODOWE I ELEWACYJNE
GARDEN AND WALL-MOUNTED FIXTURES
САДОВЫЕ И ФАСАДНЫЕ СВЕТИЛЬНИКИ
GARTEN- UND FASSADENLEUCHTEN
KERTI ÉS HOMLOKZATI KERETEK

PL Oprawa elewacyjna
EN Façade fitting
RU Фасадный светильник
DE Fassadenleuchte
HU Homlokzati lámpatest

MILAN



OS-MILA00A-00



OS-MILA00U-00

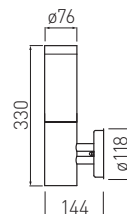

OS-MILA00A-00



OS-MILA00U-00



OS-MILA00A-00	stal nierdzewna, PC stainless steel, PC нержавеющая сталь, ПК rostfreier Stahl, PC rozsdamentes acél, PC	inox	502 g	5901867199218
OS-MILA00U-00			358 g	5901867199195



PL Oprawa ogrodowa
EN Garden luminaire
RU Садовый светильник
DE Gartenleuchte
HU Kerti LED lámpatest

MILAN



OS-MILA45P-00



OS-MILA10P-00



OS-MILA45P-00

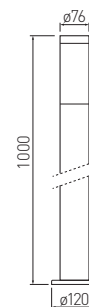

OS-MILA10P-00



OS-MILA10P-00	stal nierdzewna, PC stainless steel, PC нержавеющая сталь, ПК rostfreier Stahl, PC rozsdamentes acél, PC	inox	876 g	5901867199256
OS-MILA45P-00			463 g	5901867199232





PL Oprawa elewacyjna
EN Façade fitting
RU Фасадный светильник
DE Fassadenleuchte
HU Homlokzati lámpatest

GRANDE

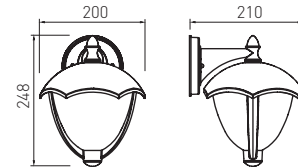

OS-GRAODA-00	aluminium, PC aluminium, PC алюминий, PC Aluminium, PC aluminium, PC	czarny, black, черный, schwarz, fekete	627 g	5901867199133
--------------	--	--	-------	---------------



PL Oprawa elewacyjna
EN Façade fitting
RU Фасадный светильник
DE Fassadenleuchte
HU Homlokzati lámpatest

GRANDE

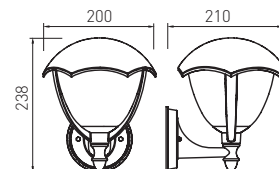

OS-GRAOUA-00	aluminium, PC aluminium, PC алюминий, PC Aluminium, PC aluminium, PC	czarny, black, черный, schwarz, fekete	627 g	5901867199157
--------------	--	--	-------	---------------





PL Oprawa ogrodowa
 EN Garden luminaire
 RU Садовый светильник
 DE Gartenleuchte
 HU Kerti LED lámpatest

GRANDE



Decorative fixtures

OS-GRA00P-00	aluminium, PC aluminium, PC алюминий, PC Aluminium, PC aluminium, PC	czarny, black, черный, schwarz, fekete	1020 g	5901867199119

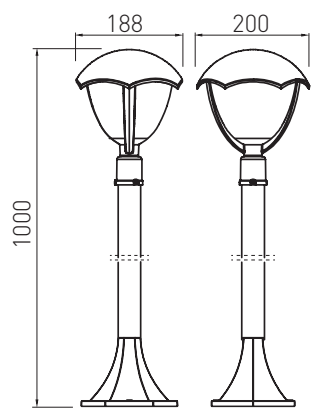



PL Oprawa elewacyjna
EN Façade fitting
RU Фасадный светильник
DE Fassadenleuchte
HU Homlokzati lámpatest

TOSKANA

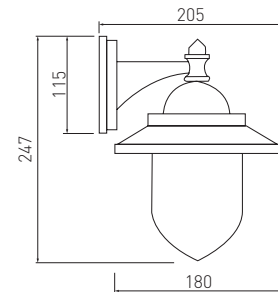

OS-TOS0DA-00	aluminium, PC aluminium, PC алюминий, PC Aluminium, PC aluminium, PC	627 g	5901867199171
--------------	--	-------	---------------



Decorative fixtures

PL Oprawa elewacyjna
EN Facade luminaire
RU Фасадный светильник
DE Fassadenleuchte
HU Homlokzati lámpatest

ASTRIT



Grey

Black

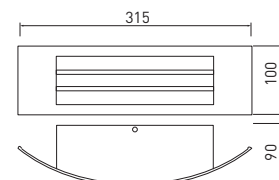

OS-ASTRITE27-20	tworzywo, plastic, пластмасса, Kunststoff, anyag	czarny, black, черный, schwarz, fekete	450 g	5901867190826
OS-ASTRITE27-80		szary, grey, серый, grau, szürke	450 g	5901867190802





PL Oprawa ścienna
EN Wall mounted fixture
RU Настенный светильник
DE Wandlampe
HU Fali lámpatest



NESSA



Grey

Black

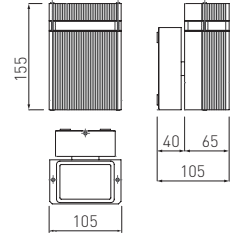

INFO



LD-NESSAGU10J-80	stop aluminium; szkło hartowane, aluminium alloy; tempered glass, сплав алюминия; закаленное стекло, Aluminiumlegierung; gehärtetes Glas, aluminium öntvény; hőkezelt üveg	szary, grey, серый, grau, szürke	jednokierunkowa, unidirectional, однонаправленный, unidirektional, egyirányú	850 g	5901867122230
LD-NESSAGU10J-20		czarny, black, черный, schwarz, fekete			5901867122254



PL Oprawa ścienna
EN Wall mounted fixture
RU Настенный светильник
DE Wandlampe
HU Fali lámpatest



NESSA



Grey

Black

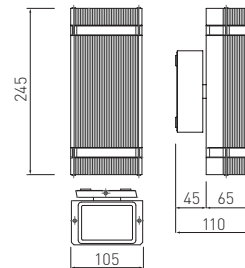

INFO



LD-NESSAGU10D-80	stop aluminium; szkło hartowane, aluminium alloy; tempered glass, сплав алюминия; закаленное стекло, Aluminiumlegierung; gehärtetes Glas, aluminium öntvény; hőkezelt üveg	szary, grey, серый, grau, szürke	dwukierunkowa, bidirectional, двунаправленный, bidirektional, kétirányú	1100 g	5901867122193
LD-NESSAGU10D-20		czarny, black, черный, schwarz, fekete			5901867122216



PL Oprawa ścienna
EN Wall mounted fixture
RU Настенный светильник
DE Wandlampe
HU Fali lámpatest



SILVA



Grey

Black

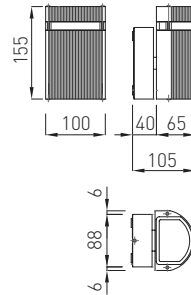

INFO



LD-SILVAGU10J-80	stop aluminium; szkło hartowane, aluminium alloy; tempered glass, сплав алюминия; закаленное стекло, Aluminiumlegierung; gehärtetes Glas, aluminium öntvény; hőkezelt üveg	szary, grey, серый, grau, szürke	jednokierunkowa, unidirectional, однонаправленный, unidirektional, egyirányú	800 g	5901867122117
LD-SILVAGU10J-20	stop aluminium; szkło hartowane, aluminium alloy; tempered glass, сплав алюминия; закаленное стекло, Aluminiumlegierung; gehärtetes Glas, aluminium öntvény; hőkezelt üveg	czarny, black, черный, schwarz, fekete			5901867122131



Decorative fixtures

PL Oprawa ścienna
EN Wall mounted fixture
RU Настенный светильник
DE Wandlampe
HU Fali lámpatest

SILVA



Grey

Black

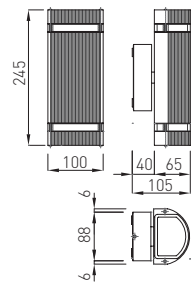

INFO



LD-SILVAGU10D-80	stop aluminium; szkło hartowane, aluminium alloy; tempered glass, сплав алюминия; закаленное стекло, Aluminiumlegierung; gehärtetes Glas, aluminium öntvény; hőkezelt üveg	szary, grey, серый, grau, szürke	dwukierunkowa, bidirectional, двунаправленный, bidirektional, kétirányú	1100 g	5901867122155
LD-SILVAGU10D-20	stop aluminium; szkło hartowane, aluminium alloy; tempered glass, сплав алюминия; закаленное стекло, Aluminiumlegierung; gehärtetes Glas, aluminium öntvény; hőkezelt üveg	czarny, black, черный, schwarz, fekete			5901867122179



PL Oprawa elewacyjna
EN Facade luminaire
RU Фасадный светильник
DE Fassadenleuchte
HU Homlokzati lámpatest

BALEO



LD-BA2E27-00



LD-BA2GU10-0M

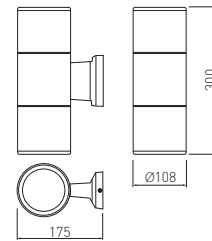

LD-BA2E27-00

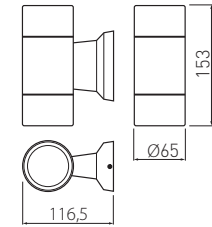

LD-BA2GU10-0M



INFO



LD-BA2E27-00	2 x max 40 W	E27	stop aluminium; szkło hartowane, aluminium alloy; tempered glass, сплав алюминия; закаленное стекло, Aluminiumlegierung; gehärtetes Glas, aluminium öntvény; hőkezelt üveg	szary, grey, серый, grau, szürke	dwukierunkowa, bidirectional, двунаправленный, bidirektional, kétirányú	900 g	5901867136930
LD-BA2GU10-0M	2 x max 10 W	GU10				400 g	5901867136893



PL Oprawa elewacyjna
EN Facade luminaire
RU Фасадный светильник
DE Fassadenleuchte
HU Homlokzati lámpatest

BALEO



LD-BALE27-00



LD-BALGU10-0S

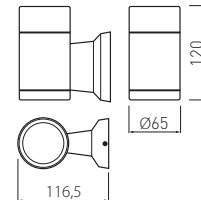

LD-BALE27-00

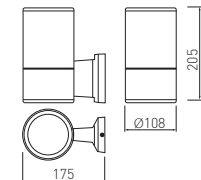

LD-BALGU10-0S



INFO



LD-BALGU10-0S	1 x max 10 W	GU10	stop aluminium; szkło hartowane, aluminium alloy; tempered glass, сплав алюминия; закаленное стекло, Aluminiumlegierung; gehärtetes Glas, aluminium öntvény; hőkezelt üveg	szary, grey, серый, grau, szürke	jednokierunkowa, unidirectional, однонаправленный, unidirektional, egyirányú	300 g	5901867136879
LD-BALE27-00	1 x max 40 W	E27				600 g	5901867136916



PL Oprawa elewacyjna
EN Facade luminaire
RU Фасадный светильник
DE Fassadenleuchte
HU Homlokzati lámpatest



TIAGO



Inox

Black

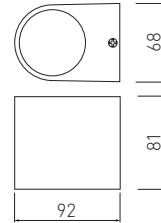

				INFO		
LD-TIAGOGU10J-20	1 x max 35 W	stop aluminium; szkło hartowane, aluminium alloy; tempered glass, сплав алюминия; закаленное стекло, Aluminiumlegierung; gehärtetes Glas, aluminium öntvény; hőkezelt üveg	czarny, black, черный, schwarz, fekete	jednokierunkowa, unidirectional, однонаправленный, unidirektional, egyrányú	300 g	5901867162144
LD-TIAGOGU10J-01			inox			5902801255984



PL Oprawa elewacyjna
EN Facade luminaire
RU Фасадный светильник
DE Fassadenleuchte
HU Homlokzati lámpatest

TIAGO



Inox

Black

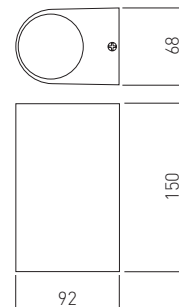

				INFO		
LD-TIAGOGU10D-20	2 x max 35 W	stop aluminium; szkło hartowane, aluminium alloy; tempered glass, сплав алюминия; закаленное стекло, Aluminiumlegierung; gehärtetes Glas, aluminium öntvény; hőkezelt üveg	czarny, black, черный, schwarz, fekete	dwukierunkowa, bidirectional, двунаправленный, bidirektional, kétirányú	470 g	5901867162151
LD-TIAGOGU10D-01			inox			5902801256042



PL Oprawa ogrodowa
EN Garden luminaire
RU Садовый светильник
DE Gartenleuchte
HU Kerti LED lámpatest

DIEGO



Grey

Black

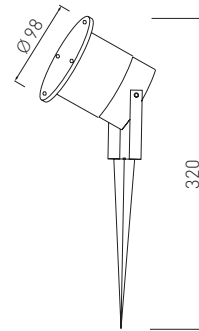

OS-DIEGOGU10-20	aluminium aluminium алюминий Aluminium aluminium	czarny, black, черный, schwarz, fekete	330 g	5901867185716
OS-DIEGOGU10-80		szary, grey, серый, grau, szürke		5902801256493



PL Oprawa dogruntowa
EN Garden fixture
RU Светильник садовый
DE Garten-Bodenleuchte
HU Taposólámpa

ALFA



ON-ALFAOGU10-06



ON-ALFAKGU10-06

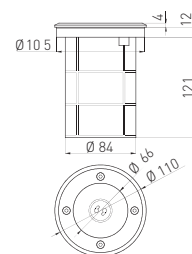

ON-ALFAOGU10-06

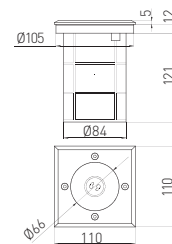

ON-ALFAKGU10-06



ON-ALFAOGU10-06	pierścień - stal nierdzewna, korpus - aluminium, puszka montażowa - PC, Ring - stainless steel, body - aluminum, assembly box - PC, кольцо - нержавеющая сталь, корпус - алюминий, монтажная чашка - поликарбонат, Ring - Edelstahl, Gehäuse - Aluminium, Montagebox - PC, gyűrű - rozsdamentes acél; ház - műanyag	500 g	5901867109934
ON-ALFAKGU10-06		700 g	5901867109958



PL Oprawa wbudowana podłogowa
EN Floor built-in fixture
RU Напольный встраиваемый светильник
DE Fußbodeneinbauleuchte
HU Taposólámpa

ALFA MINI



ON-ALFAOGU10-06



ON-ALFAKGU10-06

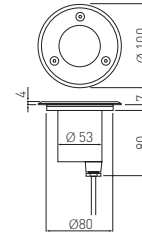

ON-ALFAOGU10-06

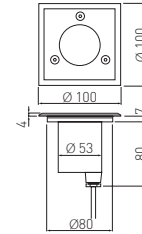

ON-ALFAKGU10-06



ON-ALFAOGU10-06-MINI	pierścień - stal nierdzewna; obudowa - aluminium, ring - stainless steel; enclosure - aluminium, кольцо - нержавеющая сталь; корпус - алюминий, Ring - rostfreier Stahl; Gehäuse - Aluminium, gyűrű - rozsdamentes acél; ház - aluminium	370 g	5901867119889
ON-ALFAKGU10-06-MINI			5901867119896



PL Pokrywka jednokierunkowa i dwukierunkowa do oprawy najazdowej
EN Unidirectional & bidirectional diffuser shroud for driveway flush fixtures
RU Крышка однонаправленная и двунаправленная для наездного светильника
DE Uni- und Bidirektionale Abdeckung für Einfahrtlampe
HU Egyirányú és kétirányú fedél taposólámpák részére



ALFA-O



ON-ALFAO-C1W



ON-ALFAO-C2W

ON-ALFAO-C1W	ON-ALFAOGU10-06 ON-ALFAKGU10-06	pokrywka jednokierunkowa, unidirectional diffuser shroud, Unidirektionale Abdeckung, jednosměrný kryt, egyirányú fedél	stal nierdzewna stainless steel нержавеющая сталь nerezová ocel rozsdamentes acél	5901867122360
ON-ALFAO-C2W		pokrywka dwukierunkowa, bidirectional diffuser shroud, двунаправленная крышка, bidirektionale Abdeckung, kétirányú fedél		5901867122384





LAMPKI
DESK LAMPS
НАСТОЛЬНЫЕ ЛАМПЫ
SCHREIBTISCHLAMPEN
ASZTALI LÁMPÁK

PL Lampka biurkowa LED
 EN Desktop LED lamp
 RU Настольная светодиодная лампа
 DE LED-Schreibtischlampe
 HU LED asztali lámpa

GALACTIC LED

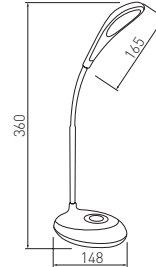

LB-GAL3WRU-10	3 W	120 lm	● 4000 K	tworzywo, plastic, пластмасса, Kunststoff, anyag	biały white белый weiß fehér	314 g	5902801010392



PL Lampka biurkowa LED
 EN Desktop LED lamp
 RU Настольная светодиодная лампа
 DE LED-Schreibtischlampe
 HU LED asztali lámpa

GALACTIC LED

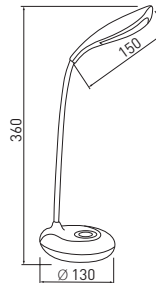

LB-GAL5WRU-10	5 W	240 lm	● 4000 K	tworzywo, plastic, пластмасса, Kunststoff, anyag	biały white белый weiß fehér	554 g	5902801010408



Decorative fixtures

PL Lampka biurkowa LED
EN Desktop LED lamp
RU Настольная светодиодная лампа
DE LED-Schreibtischlampe
HU LED asztali lámpa

GALACTIC LED

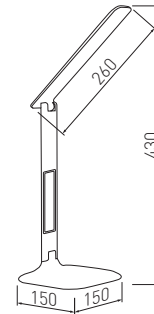

LB-GAL5WM0-10	5 W	240 lm	<ul style="list-style-type: none"> ● 3000 K ● 4000 K ● 6400 K 	tworzywo, plastic, пластик, Kunststoff, anyag	biały white, белый, weiß, fehér	732 g	5902801010514
---------------	-----	--------	--	---	---------------------------------	-------	---------------



PL Lampa podłogowa
EN Floor lamp
RU Торшер
DE Stehlampe
HU Állólámpa

BENFICA 2

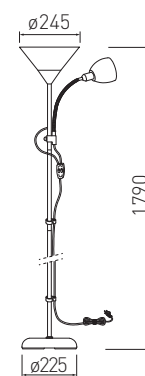

LP-BENFICA2-80	E27 - max 60 W E14 - max 40 W	tworzywo + metal, plastic + metal, пластик + металл, Kunststoff + Metall, anyag + fém	szary, grey, серый, grau, szürke	3000 g	5901867196064
----------------	----------------------------------	---	----------------------------------	--------	---------------









SYSTEMY SZYNOWE
TRACK SYSTEMS
ТРЕКОВЫЕ СИСТЕМЫ ОСВЕЩЕНИЯ
SCHIENENSYSTEME
DÍSZVILÁGÍTÁS



Reflektory LED	
Spot lights LED	
Светодиодные лампы	
Spotlights LED	
Raszter, lencsés és modul lámpatestek.....	215.
Szynoprzewody	
Track systems	
Шинопровод	
Schienensysteme	
Plafonkeretek.....	218.



REFLEKTORY LED
SPOT LIGHTS LED
СВЕТОДИОДНЫЕ ЛАМПЫ
SPOTLIGHTS LED
RASZTER, LENCSES ÉS MODUL LÁMPATESTEK

PL Reflektor LED X-Line
EN X-Line LED reflector
RU Светодиодный рефлектор X-Line
DE Spotlight LED X-Line
HU X-Line reflektorfény



XLD-1524XLN-CB0	15 W	● 3000 K	1094 lm	biały, white, белый, weiß, fehér	24°	0,6 kg	5901867199799
XLD-1540XLN-CB0					40°		5901867199805
XLD-1560XLN-CB0					60°		5901867199812
XLD-1524XLN-NB0		● 4000 K			24°		5901867199829
XLD-1540XLN-NB0					40°		5901867199836
XLD-1560XLN-NB0					60°		5901867199843
XLD-3024XLN-CB0	30 W	● 3000 K	2052 lm		24°	1,2 kg	5901867199850
XLD-3040XLN-CB0					40°		5901867199867
XLD-3060XLN-CB0					60°		5901867199874
XLD-3024XLN-NB0		● 4000 K			24°		5901867199881
XLD-3040XLN-NB0					40°		5901867199898
XLD-3060XLN-NB0					60°		5901867199904
XLD-4024XLN-CB0	40 W	● 3000 K	3245 lm	24°	1,5 kg	5901867199911	
XLD-4040XLN-CB0				40°		5901867199928	
XLD-4060XLN-CB0				60°		5901867199935	
XLD-4024XLN-NB0		● 4000 K		24°		5901867199942	
XLD-4040XLN-NB0				40°		5901867199959	
XLD-4060XLN-NB0				60°		5901867199966	

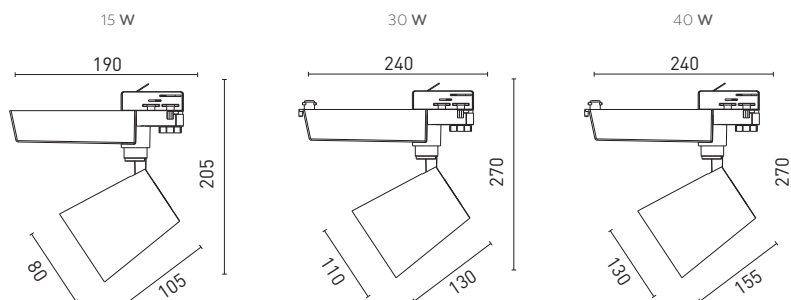

PL Reflektor LED X-Line
 EN X-Line LED reflector
 RU Светодиодный рефлектор X-Line
 DE Spotlight LED X-Line
 HU X-Line reflektorfény

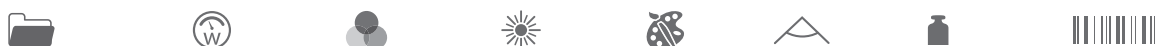

XLD-1524XLN-CB1	15 W	● 3000 K	1094 lm	czarny, black, черный, schwarz, fekete	24°	0,6 kg	5901867199973
XLD-1540XLN-CB1					40°		5901867199980
XLD-1560XLN-CB1					60°		5902801000010
XLD-1524XLN-NB1		● 4000 K			24°		5902801000027
XLD-1540XLN-NB1					40°		5902801000034
XLD-1560XLN-NB1					60°		5902801000041
XLD-3024XLN-CB1	30 W	● 3000 K	2052 lm		24°	1,2 kg	5902801000058
XLD-3040XLN-CB1					40°		5902801000065
XLD-3060XLN-CB1					60°		5902801000072
XLD-3024XLN-NB1		● 4000 K			24°		5902801000089
XLD-3040XLN-NB1					40°		5902801000096
XLD-3060XLN-NB1					60°		5902801000102
XLD-4024XLN-CB1	40 W	● 3000 K	3245 lm	24°	1,5 kg	5902801000119	
XLD-4040XLN-CB1				40°		5902801000126	
XLD-4060XLN-CB1				60°		5902801000133	
XLD-4024XLN-NB1		● 4000 K		24°		5902801000140	
XLD-4040XLN-NB1				40°		5902801000157	
XLD-4060XLN-NB1				60°		5902801000164	

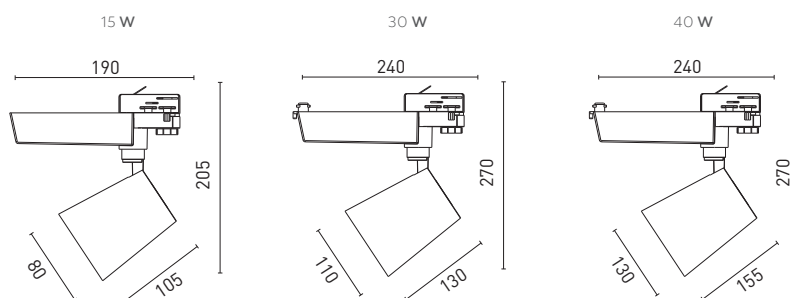

Track systems





SZYNOPRZEWODY
TRACK SYSTEMS
ШИНОПРОВОД
SCHIENENSYSTEME
PLAFONKERETEK

PL Szynoprzewód 3-fazowy
EN 3-circuit track
RU Шинопровод 3-фазовый
DE Dreiphasenschiene
HU Plafonkeret 3 fázisos

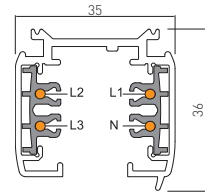

XTR-RA3FZ1B-00	biały, white, белый, weiß, fehér	1 m	5901867193131
XTR-RA3FZ1C-10	czarny, black, черный, schwarz, fekete	1 m	5901867193155
XTR-RA3FZ2B-00	biały, white, белый, weiß, fehér	2 m	5901867193162
XTR-RA3FZ2C-10	czarny, black, черный, schwarz, fekete	2 m	5901867193179



PL Zakończenie szynoprzewodu
EN End cap
RU Заглушка шинопровода
DE Schienensystemendkarpe
HU Plafonkeret végzáró

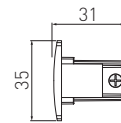

XAE-ZKUNCB-00	biały, white, белый, weiß, fehér	5901867193346
XAE-ZKUNCC-10	czarny, black, черный, schwarz, fekete	5901867193353

PL Końcówka zasilająca
EN 3-circuit live-end connector
RU Наконечник подвода питания
DE Energieversorgungsanschluss
HU 3 fázisos plafonkeret végzáró

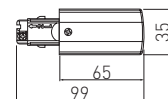

XAE-KZASLB-00	biały, white, белый, weiß, fehér	5901867193308
XAE-KZASLC-10	czarny, black, черный, schwarz, fekete	5901867193315





PL Końcówka zasilająca
EN 3-circuit live-end connector
RU Наконечник подвода питания
DE Energieversorgungsanschluss
HU 3 fázisos plafonkeret végzáró

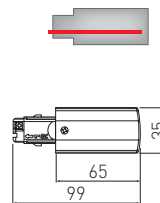

XAE-KZASPB-00	biały, white, белый, weiß, fehér	5901867193339
XAE-KZASPC-10	czarny, black, черный, schwarz, fekete	5901867193322



PL Łącznik „L” regulowany
EN 3-circuit adjustable „L” connector
RU Соединитель угловой 90°
DE "L" Verbindungsstück, regulierbar
HU 3 fázisos állítható L csatlakozó

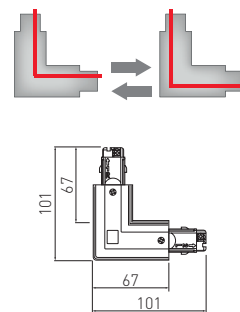
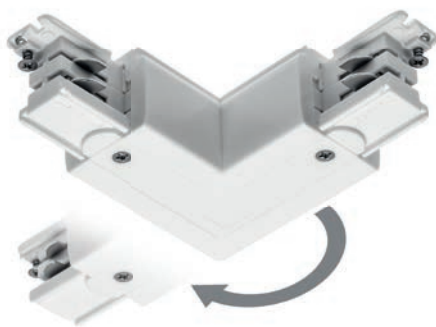

XAE-LKLRZWB-00	biały, white, белый, weiß, fehér	5901867193544
XAE-LKLRZWC-10	czarny, black, черный, schwarz, fekete	5901867193551



PL Łącznik „L”
EN 3-circuit „L” connector 90°
RU Соединитель угловой 90°
DE "L" Verbindungsstück
HU 3 fázisos L csatlakozó

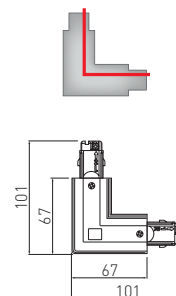

XAE-LKLPWB-00	biały, white, белый, weiß, fehér	5901867193407
XAE-LKLPWC-10	czarny, black, черный, schwarz, fekete	5901867193414





PL Łącznik „L”
EN 3-circuit „L” connector 90°
RU Соединитель угловой 90°
DE "L" Verbindungsstück
HU 3 fázisos L csatlakozó

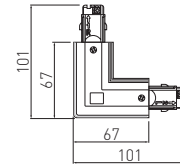

XAE-LKLLZB-00	biały, white, белый, weiß, fehér	5901867193421
XAE-LKLLZC-10	czarny, black, черный, schwarz, fekete	5901867193438



PL Łącznik „T”
EN 3-circuit „T” connector
RU Соединитель угловой „T”
DE "T" Verbindungsstück
HU 3 fázisos T csatlakozó

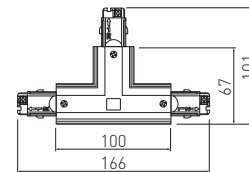
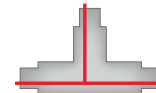
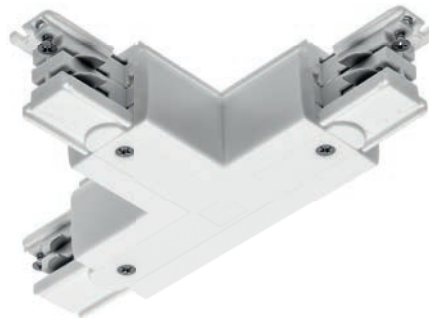

XAE-LKTZPB-00	biały, white, белый, weiß, fehér	5901867193469
XAE-LKTZPC-10	czarny, black, черный, schwarz, fekete	5901867193476



PL Łącznik „T”
EN 3-circuit „T” connector
RU Соединитель угловой „T”
DE "T" Verbindungsstück
HU 3 fázisos T csatlakozó

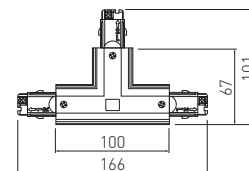
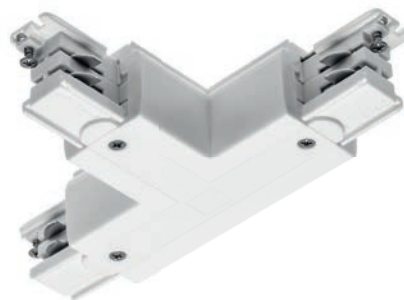

XAE-LKTZLB-00	biały, white, белый, weiß, fehér	5901867193483
XAE-LKTZLC-10	czarny, black, черный, schwarz, fekete	5901867193490



PL Łącznik „T”
EN 3-circuit „T” connector
RU Соединитель угловой „Т”
DE "T" Verbindungsstück
HU 3 fázisos T csatlakozó

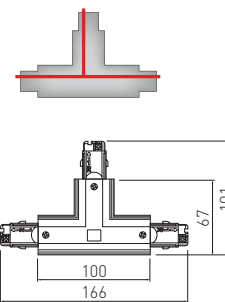
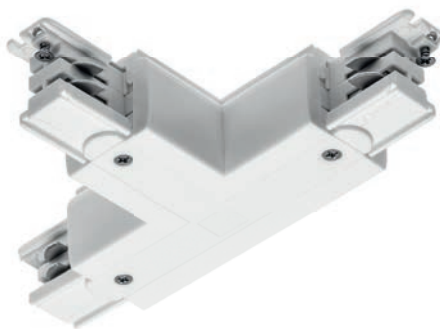

XAE-LKTWPB-00	biały, white, белый, weiß, fehér	5902801001284
XAE-LKTWPC-10	czarny, black, черный, schwarz, fekete	5902801001291



PL Łącznik „T”
EN 3-circuit „T” connector
RU Соединитель угловой „Т”
DE "T" Verbindungsstück
HU 3 fázisos T csatlakozó

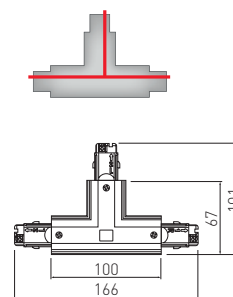
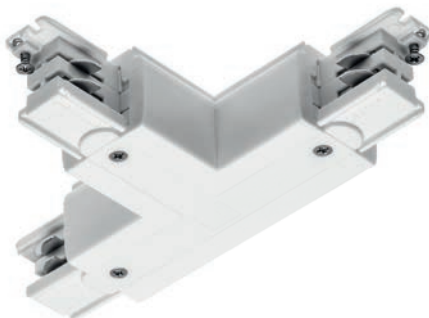

XAE-LKTWLB-00	biały, white, белый, weiß, fehér	5902801001307
XAE-LKTWLC-10	czarny, black, черный, schwarz, fekete	5902801001314



PL Łącznik „X”
EN 3-circuit „X” connector
RU Соединитель угловой „X”
DE "X" Verbindungsstück
HU 3 fázisos X csatlakozó

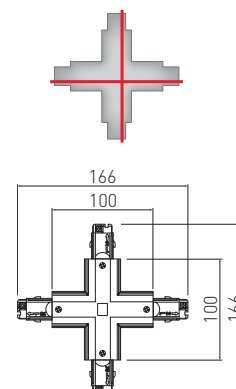
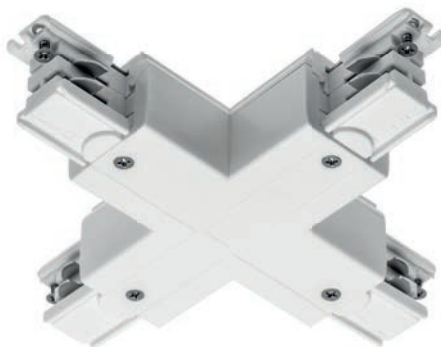

XAE-LKXUB-00	biały, white, белый, weiß, fehér	5901867193445
XAE-LKXUC-10	czarny, black, черный, schwarz, fekete	5901867193452





PL Łącznik „T” regulowany
EN 3-circuit adjustable „T” connector
RU Соединитель угловой „Т”
DE "T" Verbindungsstück, regulierbar
HU 3 fázisos állítható T csatlakozó

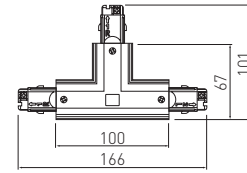
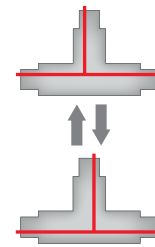
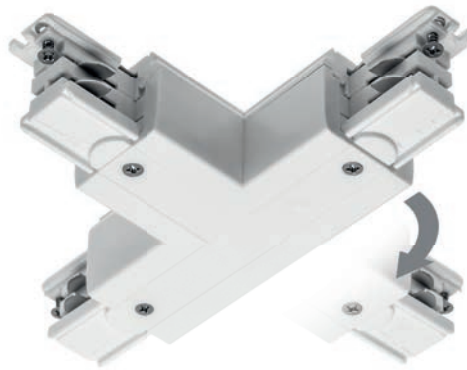

XAE-LKTRZWPB-00	biały, white, белый, weiß, fehér	5901867193568
XAE-LKTRZWPC-10	czarny, black, черный, schwarz, fekete	5901867193575



PL Łącznik „T” regulowany
EN 3-circuit adjustable „T” connector
RU Соединитель угловой „Т”
DE "T" Verbindungsstück, regulierbar
HU 3 fázisos állítható T csatlakozó

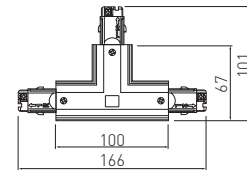
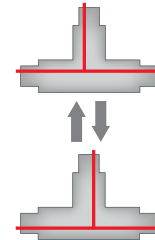
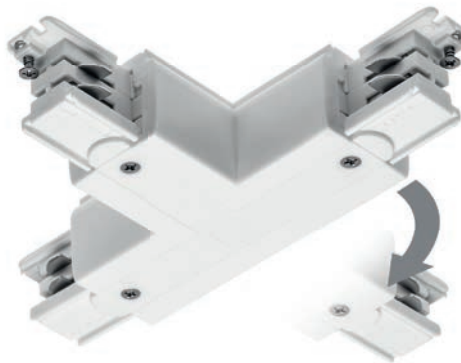

XAE-LKTRZWLB-00	biały, white, белый, weiß, fehér	5901867193582
XAE-LKTRZWLC-10	czarny, black, черный, schwarz, fekete	5901867193599



PL Łącznik prosty
EN 3-circuit connector
RU Соединитель электрический
DE Gerades Verbindungsstück
HU 3 fázisos csatlakozó

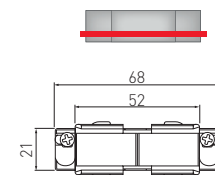

XAE-LKELB-00	biały, white, белый, weiß, fehér	5901867193360
XAE-LKELC-10	czarny, black, черный, schwarz, fekete	5901867193377





PL Łącznik prosty
EN 3-circuit connector
RU Соединитель электрический
DE Gerades Verbindungsstück
HU 3 fázisos csatlakozó

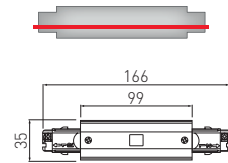

XAE-LELZB-00	biały, white, белый, weiß, fehér	5901867193384
XAE-LELZC-10	czarny, black, черный, schwarz, fekete	5901867193391



PL Łącznik regulowany
EN 3-circuit adjustable connector
RU Соединитель регулируемый
DE Regulierbares Verbindungsstück
HU 3 fázisos állítható csatlakozó

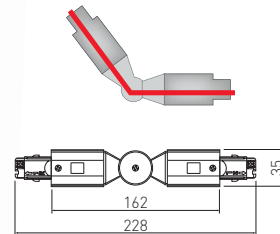

XAE-LKRUB-00	biały, white, белый, weiß, fehér	5901867193520
XAE-LKRUC-10	czarny, black, черный, schwarz, fekete	5901867193537



PL Łącznik elastyczny
EN 3-circuit flexible connector
RU Соединитель гибкий
DE Elastisches Verbindungsstück
HU 3 fázisos rugalmas csatlakozó

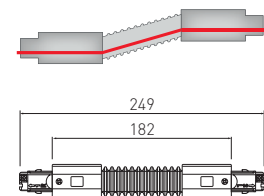
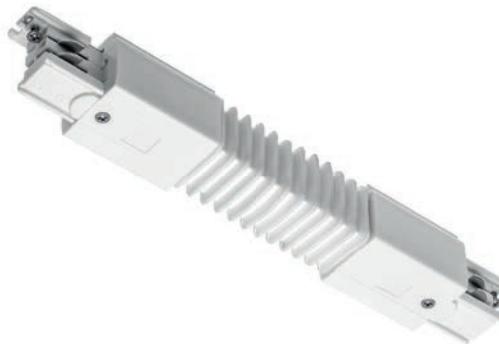

XAE-LELUB-00	biały, white, белый, weiß, fehér	5901867193506
XAE-LELUC-10	czarny, black, черный, schwarz, fekete	5901867193513





- PL Zestaw mocowanie sufitowe E-Z Click z linką
 EN Ceiling mount suspension kit with wire
 RU Крепление потолочное E-Z Click
 DE Deckenhalterung für Schienensystem (Set E-Z Click mit Seil)
 HU Mennyezetre szerelhető felfüggesztő készlet (E-Z Click és drót)

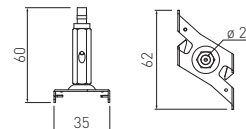
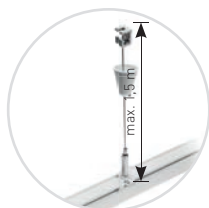

XAE-ZZWECLB-00	biały, white, белый, weiß, fehér	5901867193605
XAE-ZZWECLC-10	czarny, black, черный, schwarz, fekete	5901867193612

- PL Zestaw mocowanie sufitowe 120 mm z linką
 EN Ceiling mount suspension kit with wire
 RU Крепление потолочное усиленное
 DE Deckenhalterung für Schienensystem (Set)
 HU Mennyezetre szerelhető felfüggesztő készlet

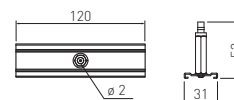

XAE-ZZWL120B-00	biały, white, белый, weiß, fehér	5901867193667
XAE-ZZWL120C-10	czarny, black, черный, schwarz, fekete	5901867193674

- PL Łącznik mechaniczny 182 mm
 EN Suspension clamp for track connection
 RU Подвесной зажим для подключения дорожки
 DE Mechanisches Verbindungsstück
 HU Felfüggesztési bilincs a síncsatlakozáshoz

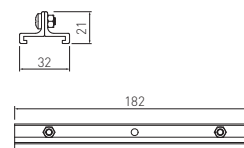

XAE-LMIZB-00	biały, white, белый, weiß, fehér	5901867193742
XAE-LMIZC-10	czarny, black, черный, schwarz, fekete	5901867193759

Track systems

PL Mocowanie sufitowe
EN Suspension kit
RU Набор для подвешивания
DE Deckenhalterung
HU Feölfügestő készlet



XAE-MSUNB-00	biały, white, белый, weiß, fehér	5901867193766
XAE-MSUNC-10	czarny, black, черный, schwarz, fekete	5901867193773

PL Mocowanie sufitowe E-Z Click T25
EN T-bar mounting kit
RU Крепление потолочное E-Z Click
DE Deckenhalterung für Schienensystem (Set E-Z Click T25)
HU Mennyezetre szerelhető felfügestő készlet (E-Z Click T25)

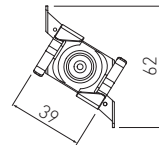
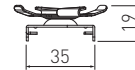

XAE-MSEZB-00	biały, white, белый, weiß, fehér	5901867193629
XAE-MSEZC-10	czarny, black, черный, schwarz, fekete	5901867193636

PL Mocowanie sufitowe 120 mm T25
EN T25 profile mounting kit
RU Крепление потолочное усиленное
DE Deckenhalterung T25
HU Feölfügestő készlet T25

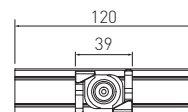

XAE-MS120B-00	biały, white, белый, weiß, fehér	5901867193704
XAE-MS120C-10	czarny, black, черный, schwarz, fekete	5901867193711





- PL Baza do montażu natynkowego
- EN Fixed monopint track adapter
- RU База для поверхностного монтажа
- DE Basis für Aufputzmontage
- HU Rögzített monopólusú adapter

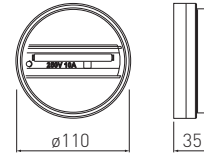

XAE-BNADB-00	biały, white, белый, weiß, fehér	5901867193780
XAE-BNADC-10	czarny, black, черный, schwarz, fekete	5901867193797

- PL Haczyk do zawieszenia
- EN Suspension hook
- RU Крючок для подвески
- DE Aufhängehaken
- HU Felfüggesztési horog

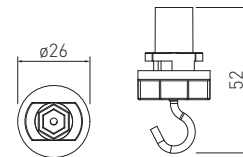

XAE-HMKB-00	biały, white, белый, weiß, fehér	5901867193728
XAE-HMKC-10	czarny, black, черный, schwarz, fekete	5901867193735

- PL Gniazdo SCHUKO
- EN Euro-trac mount electrical outlet
- RU Гнездо SCHUKO
- DE Buchse SCHUKO
- HU SCHUKO duglalat

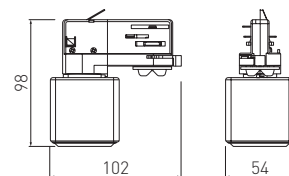

XAE-GNSCH-00	biały, white, белый, weiß, fehér	5901867193803
--------------	----------------------------------	---------------



PL Budowa systemu
EN Building the system
RU Построение системы
DE Aufbau des Schienensystems
HU Rendszer kiépítése

Zakończenie szynoprzewodu
End cap
Заглушка шинпровода
Schienensystemendkappe
Plafonkeret végzáró

Łącznik „X”
3-circuit „X” connector
Соединитель угловой „X”
"X" Verbindungsstück
3 fázisos X csatlakozó

Łącznik „T”
3-circuit „T” connector
Соединитель угловой „T”
"T" Verbindungsstück
3 fázisos T csatlakozó

Łącznik „L”
3-circuit „L” connector 90°
Соединитель угловой 90°
"L" Verbindungsstück
3 fázisos L csatlakozó

Łącznik prosty
3-circuit connector
Соединитель электрический
Gerades Verbindungsstück
3 fázisos csatlakozó

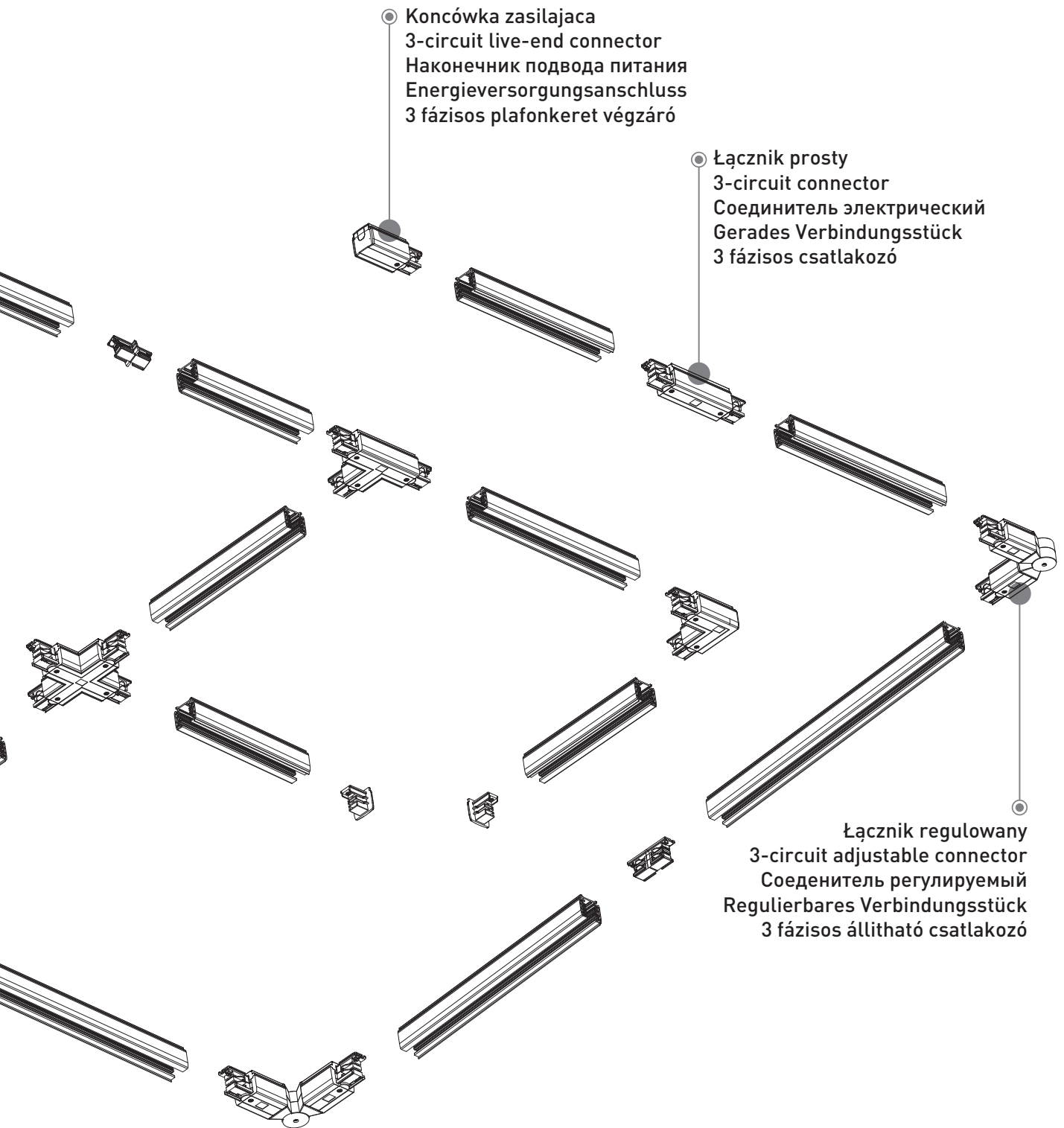

● **Koncówka zasilajaca**
3-circuit live-end connector
Наконечник подвода питания
Energieversorgungsanschluss
3 fázisos plafonkeret végzáró

● **Łącznik prosty**
3-circuit connector
Соединитель электрический
Gerades Verbindungsstück
3 fázisos csatlakozó

● **Łącznik regulowany**
3-circuit adjustable connector
Соединитель регулируемый
Regulierbares Verbindungsstück
3 fázisos állítható csatlakozó

PL Schemat łączenia
EN Connection diagram
RU Схема подключения
DE Verbindungsschema
HU Csatlakozási rajz

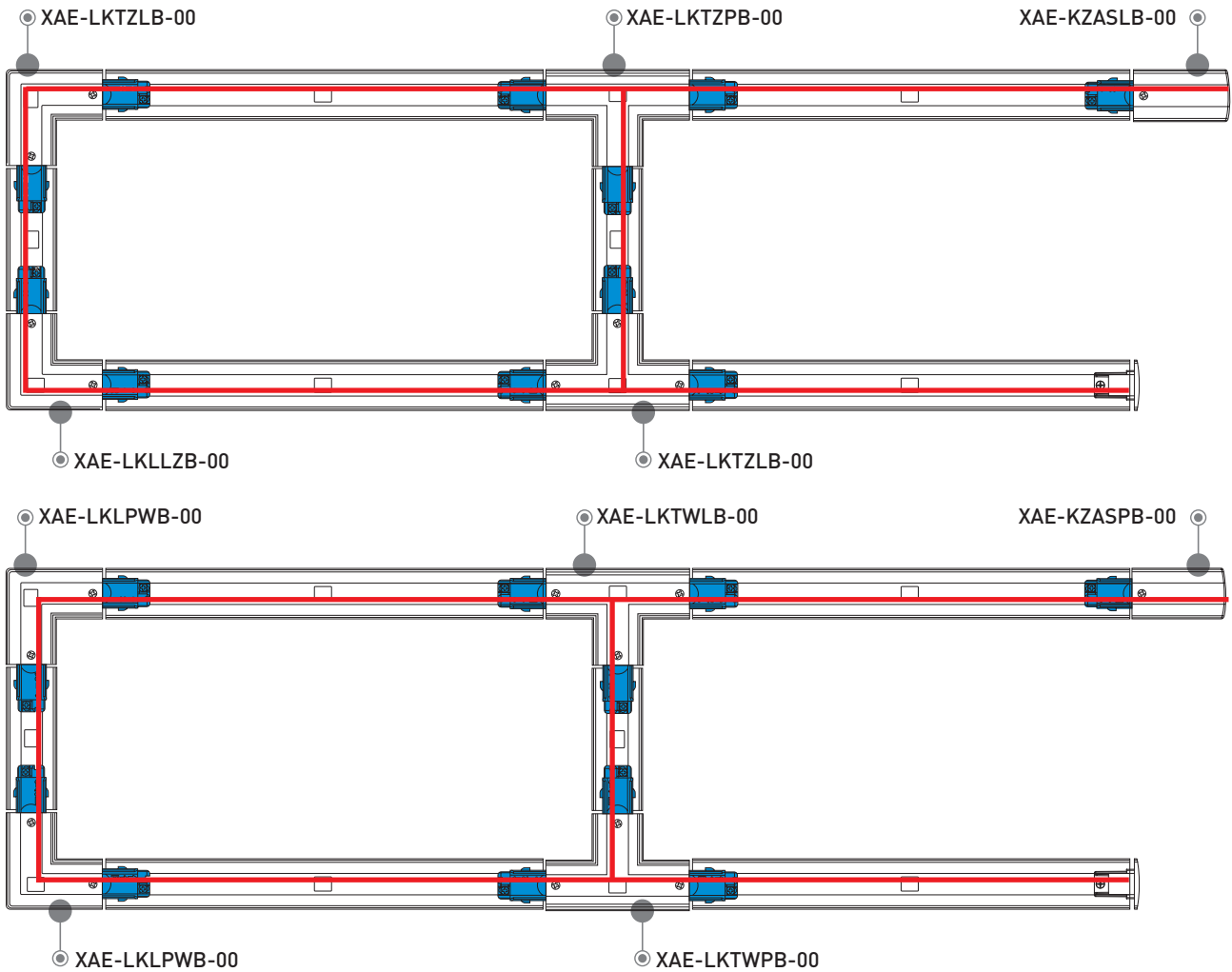

Szynoprzewód jest asymetryczny - przy doborze elementów należy zwrócić uwagę na ciągłość toru N.

Track is asymmetrical - choosing elements make sure, that the track N is continuous.

Шинопровод асимметричен - При выборе элементов, обратите внимание на непрерывность трека N.

Die Spur ist asymmetrisch- bei der Auswahl der Elemente ist es notwendig auf die Kontinuität der N-Leitung zu achten"

Aszimetrikus a vágány az elemek kiválasztásakor ügyeljen az N pálya folyamatosságára

Na rysunkach, tor N jest zaznaczony czerwoną linią.

On the drawings, the track N is marked with a red line.

На чертежах, трек N отмечен красной линией.

In den Zeichnungen ist die N-Leitung durch eine rote Linie markiert

A rajzokban az N pálya piros vonallal van jelölve







OSPRZĘT ELEKTROINSTALACYJNY
INSTALLATION FITTINGS
ЭЛЕКТРОУСТАНОВОЧНЫЕ ИЗДЕЛИЯ
ELEKTROINSTALLATIONSUSRUSTUNG
ELEKTROINSTALLACIOS TERMEKEK



Osprzęt elektroinstalacyjny	
Installation fittings	
Электроустановочные изделия	
Elektroinstallationsausrüstung	
elektroinstallacios termekek.....	232







PL Czujnik ruchu
EN Motion detector
RU Датчик движения
DE Bewegungsmelder
HU Mozgásérzékelő

CR-1



CR-CR1000-10



CR-CR1000-00

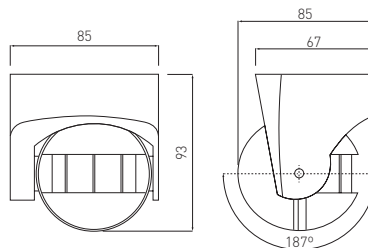

CR-CR1000-10	tworzywo, plastic, пластмасса, Kunststoff, nanyag	czarny, black, черный, schwarz, fekete	160 g	5908231308184
CR-CR1000-00		biały, white, белый, weiß, fehér		5908231308160



PL Czujnik ruchu
EN Motion detector
RU Датчик движения
DE Bewegungsmelder
HU Mozgásérzékelő



CR-2



CR-CR2000-10



CR-CR2000-00

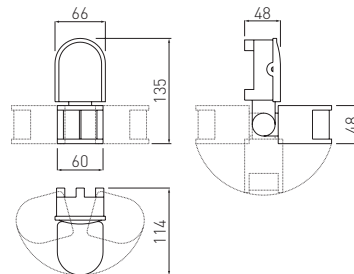

CR-CR2000-10	tworzywo, plastic, пластмасса, Kunststoff, nanyag	czarny, black, черный, schwarz, fekete	180 g	5908231308238
CR-CR2000-00		biały, white, белый, weiß, fehér		5908231308207





PL Czujnik ruchu
EN Motion detector
RU Датчик движения
DE Bewegungsmelder
HU Mozgásérzékelő

CR-3

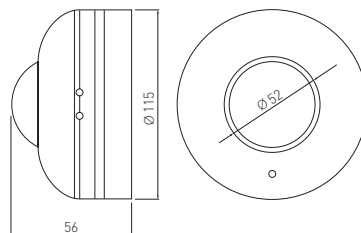

CR-CR3000-00	tworzywo, plastic, пластмасса, Kunststoff, nanyag	biały, white, белый, weiß, fehér	170 g	5908231308146
--------------	---	----------------------------------	-------	---------------



PL Czujnik ruchu
EN Motion detector
RU Датчик движения
DE Bewegungsmelder
HU Mozgásérzékelő

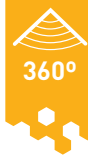

CR-3 MINI

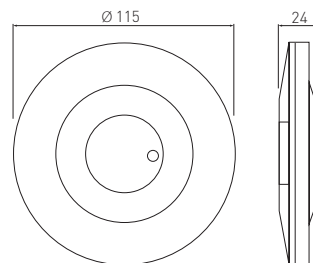

CR-CR3M00-00	tworzywo, plastic, пластмасса, Kunststoff, nanyag	biały, white, белый, weiß, fehér	100 g	5901867146076
--------------	---	----------------------------------	-------	---------------





PL Czujnik ruchu
EN Motion detector
RU Датчик движения
DE Bewegungsmelder
HU Mozgásérzékelő

CR-4

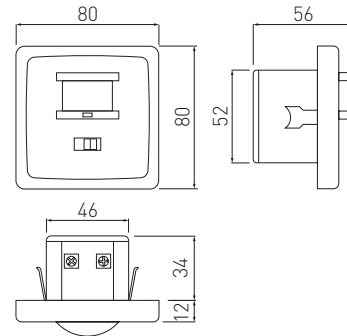

CR-CR4L00-00	tworzywo, plastic, пластмасса, Kunststoff, nanyag	biały, white, белый, weiß, fehér	100 g	5908231308122
--------------	---	----------------------------------	-------	---------------



PL Czujnik ruchu
EN Motion detector
RU Датчик движения
DE Einlass-Bewegungsmelder
HU Süllyesztett mozgásérzékelő



CR-5

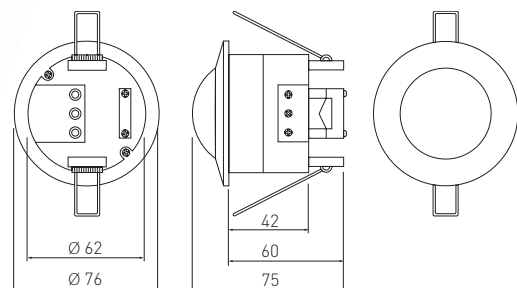

CR-CR5000-00	tworzywo, plastic, пластмасса, Kunststoff, nanyag	biały, white, белый, weiß, fehér	100 g	5908231308115
--------------	---	----------------------------------	-------	---------------





- PL Czujnik ruchu wpuszczany
- EN Recessed motion detector
- RU Датчик движения скрытый
- DE Einlass-Bewegungsmelder
- HU Süllyesztett mozgásérzékelő

CR-5 MINI

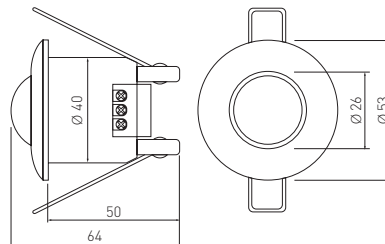

CR-CR5M00-00	tworzywo, plastic, пластмасса, Kunststoff, nanyag	biały, white, белый, weiß, fehér	50 g	5901867108890
--------------	---	----------------------------------	------	---------------



- PL Czujnik ruchu na podczerwień
- EN Infrared Motion Sensor
- RU Датчик движения инфракрасный
- DE IR-Bewegungsmelder
- HU Infravörös mozgásérzékelő



CR-6

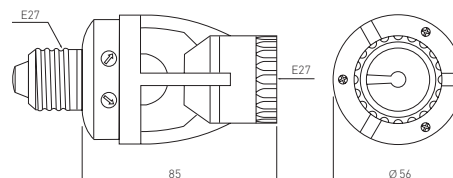

CR-CR6000-00	tworzywo, plastic, пластмасса, Kunststoff, nanyag	biały, white, белый, weiß, fehér	80 g	5901867103437
--------------	---	----------------------------------	------	---------------





PL Czujnik ruchu z zewnętrznym sensorem na podczerwień
 EN Motion detector with external IR sensor
 RU Датчик движения с наружным сенсором инфракрасный
 DE Bewegungsmelder mit externem IR-Sensor
 HU Mozgásérzékelő külső infravörös szenzorral

CR-7

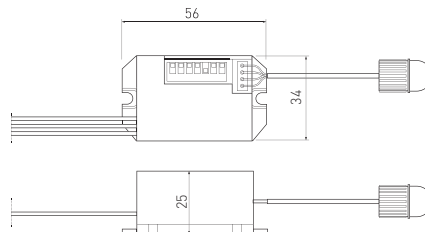

CR-CR7000-00	tworzywo, plastic, пластмасса, Kunststoff, nanyag	biały, white, белый, weiß, fehér	170 g	5901867103444
--------------	---	----------------------------------	-------	---------------



PL Czujnik ruchu
 EN Motion detector
 RU Датчик движения
 DE Einlass-Bewegungsmelder
 HU Süllyesztett mozgásérzékelő



CR-9



CR-CR9000-00

CR-CR9000-10

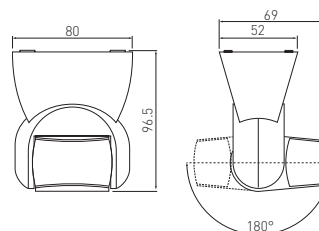

CR-CR9000-00	tworzywo, plastic, пластмасса Kunststoff, anyag	biały, white, белый, weiß, fehér	5901867108906
CR-CR9000-10		czarny, black, черный, schwarz, fekete	5901867138507



Installation fittings



PL Czujnik ruchu
EN Motion detector
RU Датчик движения
DE Bewegungsmelder
HU Mozcásérzékelő

CO-1

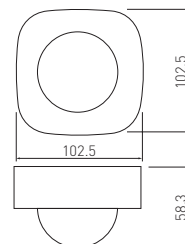

CR-CO1000-00	tworzywo, plastic, пластмасса, Kunststoff, nanyag	biały, white, белый, weiß, fehér	140 g	5901867146090
--------------	---	----------------------------------	-------	---------------



PL Czujnik ruchu i obecności
EN Motion and occupancy sensor
RU Датчик движения
DE Bewegungs- und Präsenzsensoren
HU Mozcás és jelenlétérzékelő



CR-11

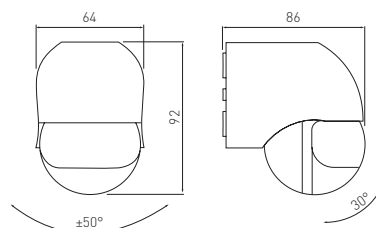

CR-CR1100-00	tworzywo, plastic, пластмасса, Kunststoff, anyag	biały, white, белый, weiß, fehér	160 g	5901867108913
--------------	--	----------------------------------	-------	---------------



PL Czujnik ruchu
EN Motion detector
RU Датчик движения
DE Bewegungsmelder
HU Mozgásérzékelő

CR-13

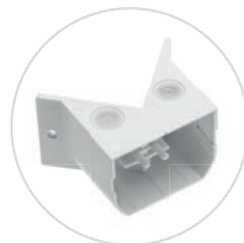

Montaż narożny
Corner mounting
Угловой монтаж
Eckmontage
Sarokba szerelhető

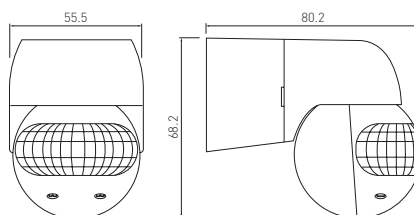

CR-CR13000-00	tworzywo, plastic, пластмасса, Kunststoff, nanyag	biały, white, белый, weiß, fehér	120 g	5901867188274
---------------	---	----------------------------------	-------	---------------



PL Czujnik ruchu
EN Motion detector
RU Датчик движения
DE Bewegungsmelder
HU Mozgásérzékelő

CR-15

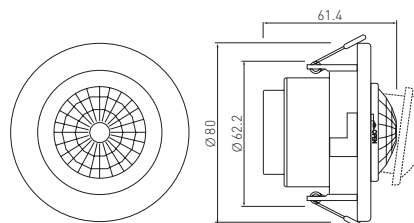

CR-CR15000-00	tworzywo, plastic, пластмасса, Kunststoff, nanyag	biały, white, белый, weiß, fehér	90 g	5901867188212
---------------	---	----------------------------------	------	---------------





PL Czujnik ruchu
EN Motion detector
RU Датчик движения
DE Bewegungsmelder
HU Mozcásérzékelő

CR-16

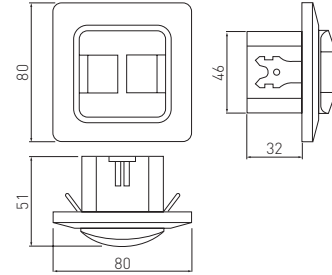

CR-CR16000-00	tworzywo, plastic, пластмасса, Kunststoff, nanyag	biały, white, белый, weiß, fehér	88 g	5902801002533
---------------	---	----------------------------------	------	---------------



PL Czujnik ruchu mikrofalowy
EN Microwave motion sensor
RU Микроволновой датчик движения
DE Mikrowellenbewegungssensor
HU Mikrohullámú mozgásérzékelő



CM-1

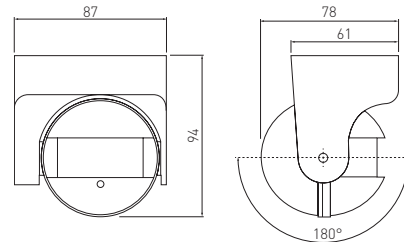

AE-CM1000-00	tworzywo, plastic, пластмасса, Kunststoff, nanyag	biały, white, белый, weiß, fehér	160 g	5901867108876
--------------	---	----------------------------------	-------	---------------





PL Mikrofalowy czujnik ruchu
 EN Microwave motion sensor
 RU Датчик движения
 DE Mikrowellen-Bewegungsmelder
 HU Mikrohullámú mozgásérzékelő

CM-3

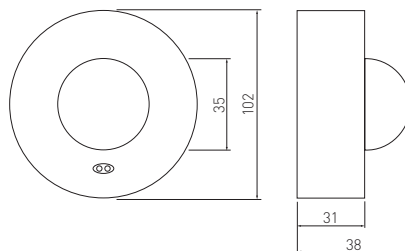

AE-CM3000-00	tworzywo, plastic, пластмасса, Kunststoff, nanyag	biały, white, белый, weiß, fehér	170 g	5908231339997
--------------	---	----------------------------------	-------	---------------



PL Mikrofalowy czujnik ruchu
 EN Microwave motion sensor
 RU Датчик движения
 DE Mikrowellen-Bewegungsmelder
 HU Mikrohullámú mozgásérzékelő



CM-3 MINI

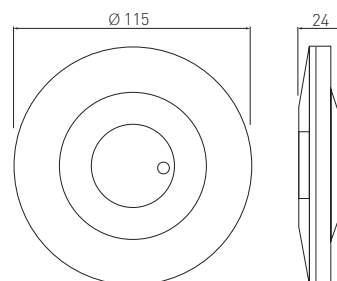

AE-CM3M00-00	tworzywo, plastic, пластмасса, Kunststoff, nanyag	biały, white, белый, weiß, fehér	110 g	5901867188250
--------------	---	----------------------------------	-------	---------------



Installation fittings





PL Mikrofalowy czujnik ruchu
 EN Microwave motion sensor
 RU Датчик движения
 DE Mikrowellen-Bewegungsmelder
 HU Mikrohullámú mozgásérzékelő

CM-4

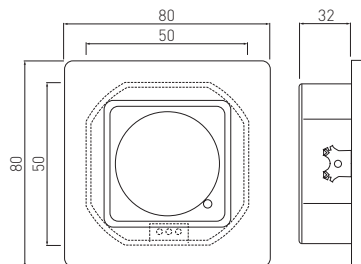

AE-CM4000-00	tworzywo, plastic, пластмасса, Kunststoff, папуэг	biały, white, белый, weiß, fehér	90 g	5901867188236
--------------	---	----------------------------------	------	---------------



PL Mikrofalowy czujnik ruchu
 EN Microwave motion sensor
 RU Датчик движения
 DE Mikrowellen-Bewegungsmelder
 HU Mikrohullámú mozgásérzékelő

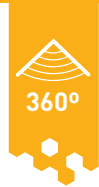

CM-5

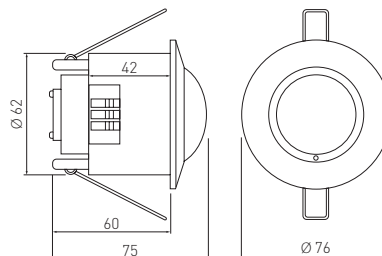

AE-CM5000-00	tworzywo, plastic, пластмасса, Kunststoff, папуэг	biały, white, белый, weiß, fehér	100 g	5901867108883
--------------	---	----------------------------------	-------	---------------





- PL Mikrofalowy czujnik ruchu
- EN Microwave motion sensor
- RU Датчик движения
- DE Mikrowellen-Bewegungsmelder
- HU Mikrohullámú mozgásérzékelő

CM-9



AE-CM9000-00



AE-CM9000-10

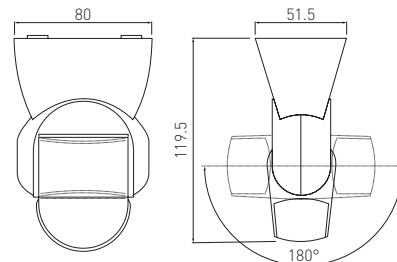

AE-CM9000-00	tworzywo, plastic, пластмасса, Kunststoff, nanyag	biały, white, белый, weiß, fehér	161 g	5901867196972
AE-CM9000-10		czarny, black, черный, schwarz, fekete		5901867196996



- PL Mikrofalowy czujnik ruchu
- EN Microwave motion sensor
- RU Датчик движения
- DE Mikrowellen-Bewegungsmelder
- HU Mikrohullámú mozgásérzékelő



CM-15

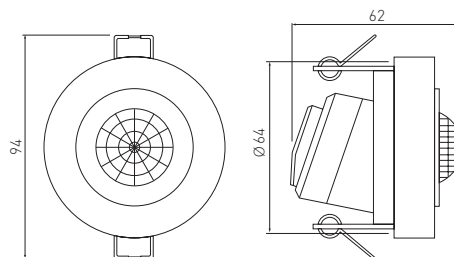

AE-CM1500-00	tworzywo, plastic, пластмасса, Kunststoff, nanyag	biały, white, белый, weiß, fehér	103 g	5902801002519



Installation fittings

PL Mikrofalowy czujnik ruchu
 EN Microwave motion sensor
 RU Датчик движения
 DE Mikrowellen-Bewegungsmelder
 HU Mikrohullámú mozgásérzékelő

SRC812-MINI

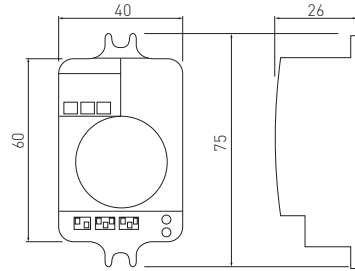

AE-SRC812-MIN	tworzywo, plastic, пластмасса, Kunststoff, panyag	biały, white, белый, weiß, fehér	40 g	5901867124326
---------------	---	----------------------------------	------	---------------



PL Mikrofalowy czujnik ruchu
 EN Microwave motion sensor
 RU Датчик движения
 DE Mikrowellen-Bewegungsmelder
 HU Mikrohullámú mozgásérzékelő

SRC812

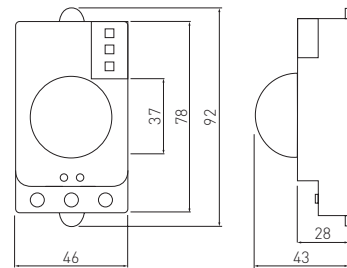

AE-SRC812-00	tworzywo, plastic, пластмасса, Kunststoff, panyag	biały, white, белый, weiß, fehér	70 g	5908231303738
--------------	---	----------------------------------	------	---------------



PL Czujnik zmierzchowy
EN Dusk sensor
RU Сумеречный датчик
DE Dämmerungssensor
HU Alkonyat érzékelő

CZ-1

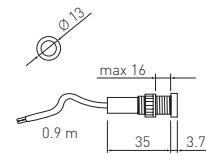
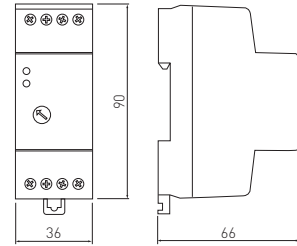

CZ-CZ1000-00	tworzywo, plastic, пластмасса, Kunststoff, nanyag	biały, white, белый, weiß, fehér	130 g	5901867108920
--------------	---	----------------------------------	-------	---------------



PL Czujnik zmierzchowy
EN Dusk sensor
RU Сумеречный датчик
DE Dämmerungssensor
HU Alkonyat érzékelő

CZ-2

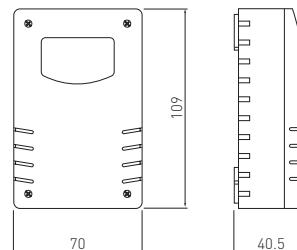

CZ-CZ2000-00	tworzywo, plastic, пластмасса, Kunststoff, nanyag	biały, white, белый, weiß, fehér	50 g	5901867108937
--------------	---	----------------------------------	------	---------------



- PL Programator czasowy mechaniczny 24 h
- EN 24h programmable timer
- RU Временной механический программатор 24 ч.
- DE Mechanische Zeitschaltuhr 24 h
- HU 24-órás mechanikus időzítő



PC-MECH24-00

PC-MECH24-SC

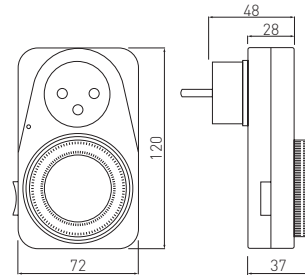

PC-MECH24-00	tworzywo, plastic, пластмасса, Kunststoff, nanyag	biały, white, белый, weiß, fehér	140 g	5908231327215
PC-MECH24-SC				5908231351104



- PL Programator czasowy elektroniczny 7 dniowy 24 h
- EN 24 h, 7 day electronic programmable timer
- RU Временной электронный программатор
- DE Elektronische 7 Tage/24 h Zeitschaltuhr
- HU 7 napi 24-órás elektronikus időzítő



PC-ELE724-00

PC-ELE724-SC

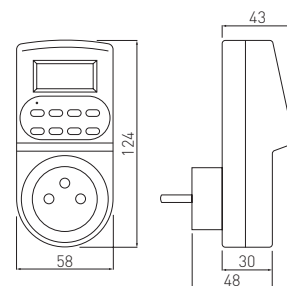

PC-ELE724-00	tworzywo, plastic, пластмасса, Kunststoff, nanyag	biały, white, белый, weiß, fehér	150 g	5908231327208
PC-ELE724-SC				5908231351128



PL Przedłużacz
EN Extension cord
RU Удлинитель
DE Steckdosenverlängerungskabel
HU Hosszabító kábel



Folder	Length (m)	Quantity	Wire Type	Barcode
AE-PS3G3M-00	3 m	3	H05VV-F 3x1.5 mm ²	5908231301192
AE-PS3G5M-00	5 m			5908231301208
AE-PS4G3M-00	3 m	4		5908231301215
AE-PS4G5M-00	5 m			5908231301222
AE-PS5G3M-00	3 m	5		5908231301239
AE-PS5G5M-00	5 m			5908231301246



PL Przedłużacz domowy
EN Extension cord
RU Удлинитель для офиса
DE Haushalts-Steckdosenverlängerungskabel
HU Hosszabító



Folder	Length (m)	Quantity	Wire Type	Barcode
AE-PF3G1M-00	1,5 m	3	H05VV-F 3G1.0 mm ²	5901867170057
AE-PF3G3M-00	3 m			5901867170033
AE-PF3G5M-00	5 m			5901867170040
AE-PF5G3M-00	3 m	5		5901867170064
AE-PF5G5M-00	5 m			5901867170071



- PL Przedłużacz bębnowy (schuko)
 EN Extension cord reel (schuko socket)
 RU Удлинитель барабанный (гнездо schuko)
 DE Trommelverlängerungskabel (schuko)
 HU Kábeldobos hosszabító kábel (fészekben schuko)



AE-SBEBEN-30	30 m	4	3 x 1,5 mm ²	tworzywo + stal plastic + steel пластик + сталь Kunststoff + Stahl műanyag + acél	czarny, black, черный, schwarz, fekete	5908231322722
AE-SBEBEN-50	50 m					5908231322739



- PL Przedłużacz bębnowy z wyłącznikiem termicznym
 EN Extension cord reel with a thermal switch
 RU Удлинитель барабанный с тепловым выключателем
 DE Trommelverlängerungskabel mit einem Thermoschalter
 HU Hosszabbítókábel tekerecs hőcserélővel



AE-PFBEBEN-20	20 m	4	3 x 1 mm ²	tworzywo + stal plastic + steel пластик + сталь Kunststoff + Stahl műanyag + acél	czarny, black, черный, schwarz, fekete	5901867170088
AE-PFBEBEN-40	40 m					5901867170095



PL Przedłużacz ogrodowy
EN Garden extension cord
RU Удлинитель садовый
DE Gartenverlängerungskabel
HU Kerti hosszabító kábel



AE-POGRODUN-10	10 m	2 x 1,0 mm ²	pomarańczowy orange оранжевый orange narancs	5901867163387
AE-POGRODUN-20	20 m			5901867163394
AE-POGRODUN-30	30 m			5901867163400



PL Gniazdo do lamp
EN Lamp base socket
RU Разъемы для ламп
DE Leuchtmittel-Fassung
HU Lámpafoglatatok



GZ-GZ10-0000	biały, white, белый, weiß, fehér	5908231305756
GZ-MR16-0000		5908231331656
GZ-G13-0000		5902801000966





PL Gniazdo do lamp
EN Lamp socket
RU Гнездо для ламп
DE Fassungen für Lampen
HU Lámpafoglatat



GZ-G90000-00

biały, white, белый, weiß, fehér

5902801222665



PL Rozgałęziacz z uziemieniem
EN Outlet junction with PE
RU Разветвитель с заземлением
DE Steckverteiler mit Erdung
HU Elosztó földeléssel



INFO



AE-RU0121-00

1 na 2 + 1, 2+1-way, 1 na 2 + 1.1 na 2 + 1

5908231301260



PL Rozgałęziacz z uziemieniem
EN Outlet junction with PE
RU Разветвитель с заземлением
DE Steckverteiler mit Erdung
HU Elosztó földeléssel



INFO



AE-RU0102-00

1 na 2, 2-way, 1 na 2, 1 na 2

5908231301253



PL Rozgałęziacz z uziemieniem
EN Outlet junction with PE
RU Разветвитель с заземлением
DE Steckverteiler mit Erdung
HU Elosztó földeléssel



AE-SC0102-00

biały, white, белый, weiß, fehér

5908231360847



PL Rozgałęziacz z uziemieniem
EN Outlet junction with PE
RU Разветвитель с заземлением
DE Steckverteiler mit Erdung
HU Elosztó földeléssel



INFO



AE-SC0103-00

1 na 3 (schuko), 3-way (schuko)
1 na 3 (schuko), 1 na 3 (schuko)

5908231360854



PL Wtyczka płaska kątowa
EN Plane angular plug
RU Плоский угловой штекер
DE Flacher Winkelstecker
HU Lapos könyökös dugasz



INFO



AE-VA1UNI-00*

biały, white, белый, weiß, fehér

5901867171887



AHTUNG:
*kein Verkauf in DE

PL Rozgałęziacz z uziemieniem
EN Outlet junction with PE
RU Разветвитель с заземлением
DE Steckverteiler mit Erdung
HU Elosztó földeléssel



INFO



AE-RU0103-00	1 na 3, 3-way, 1 на 3, 1 на 3	5908231301277
--------------	-------------------------------	---------------



PL Oprawka ceramiczna
EN Ceramic lamp holder
RU Патрон керамический
DE Keramiksocket
HU Kéramia foglalat

MAX
100 W



AE-OCEF27-00	biały, white, белый, weiß, fehér	5908231302120
--------------	----------------------------------	---------------



PL Oprawka ceramiczna
EN Ceramic lamp holder
RU Патрон керамический
DE Keramiksocket
HU Kéramia foglalat

MAX
100 W



AE-OCEE14-00	biały, white, белый, weiß, fehér	5908231302090
--------------	----------------------------------	---------------



Installation fittings

PL Oprawka ceramiczna
EN Ceramic lamp holder
RU Патрон керамический
DE Keramiksocket
HU Kéramia foglalat



AE-OCEE27-00

biały, white, белый, weiß, fehér

5908231302106



PL Oprawka ceramiczna
EN Ceramic lamp holder
RU Патрон керамический
DE Keramiksocket
HU Kéramia foglalat



AE-OCHT27-00

złoty, gold, золото, Gold, arany

5908231302113



PL Oprawka
EN Lamp holder
RU Патрон
DE Sockel
HU Foglalat



AE-OPE27K-00

biały, white, белый, weiß, fehér

5901867143341



PL Oprawka
EN Lamp holder
RU Патрон
DE Sockel
HU Foglalat



AE-OPE27P-00

biały, white, белый, weiß, fehér

5901867143327



PL Gniazdo do lamp E27
EN Lamp socket E27
RU Гнездо для ламп E27
DE Fassungen für Lampen E27
HU Lámpafoglalat E27



MAX
60 W

E27



GZ-E27000-10

czarny, black, черный, schwarz, fekete

5902801292620

GZ-E27000-00

biały, white, белый, weiß, fehér

5902801256226



PL Przejściówka
EN Adapter
RU Переходник
DE Leuchtmittel-Adapter
HU Átalakító



MAX
50 W

Installation fittings



INFO



AE-E14GU10-00

E14, GU10

biały, white, белый, weiß, fehér

5908231391797



PL Przejściówka
EN Adapter
RU Переходник
DE Leuchtmittel-Adapter
HU Átalakító



INFO



AE-E14E27-00	E14, E27	biały, white, белый, weiß, fehér	5901867112156
--------------	----------	----------------------------------	---------------



PL Przejściówka
EN Adapter
RU Переходник
DE Leuchtmittel-Adapter
HU Átalakító



INFO



AE-E27E14-00	E27, E14	biały, white, белый, weiß, fehér	5908231391780
--------------	----------	----------------------------------	---------------



PL Przejściówka
EN Adapter
RU Переходник
DE Leuchtmittel-Adapter
HU Átalakító



INFO



AE-27GU10-00	E27, GU10	biały, white, белый, weiß, fehér	5908231391803
--------------	-----------	----------------------------------	---------------



PL Przejściówka
EN Adapter
RU Переходник
DE Leuchtmittel-Adapter
HU Átalakító



INFO



AE-GU10E27-00	GU10, E27	biały, white, белый, weiß, fehér	5908231302540
---------------	-----------	----------------------------------	---------------



PL Przejściówka
EN Adapter
RU Переходник
DE Leuchtmittel-Adapter
HU Átalakító



INFO



AE-E40E27-00	E40, E27	biały, white, белый, weiß, fehér	5901867124227
--------------	----------	----------------------------------	---------------



PL Przejściówka
EN Adapter
RU Переходник
DE Befestigungsring
HU Átalakító



INFO



AE-E27RING-10	E27	biały, white, белый, weiß, fehér	590186712421
AE-E14RING-10	E14	biały, white, белый, weiß, fehér	5901867124227





- PL Wodoszczelny łącznik do przewodów elektrycznych
- EN Watertight connector for conductors
- RU Водонепроницаемый коннектор для электрических проводов
- DE Wasserdichter Verbinder für elektrische Kabel
- HU Vízhatlan kötődoboz, kábelcsatlakozó



WZL-2	tworzywo, plastic, пластмасса, Kunststoff, anyag	czarny, black, черный, schwarz, fekete	5901867122070
-------	---	--	---------------



- PL Wodoszczelny trójnik, łącznik do przewodów elektrycznych
- EN Watertight electrical wiring tee and connector
- RU Водонепроницаемый тройник и соединитель для электрических проводов
- DE Wasserdichtes T-Stück für Elektroleitungen
- HU Vízálló T-idom és csatló elektromos vezetékhez



WZL-3	tworzywo, plastic, пластмасса, Kunststoff, anyag	czarny, black, черный, schwarz, fekete	5901867122094
-------	---	--	---------------



- PL Wodoszczelny trójnik, łącznik do przewodów elektrycznych
- EN Watertight electrical wiring tee and connector
- RU Водонепроницаемый тройник и соединитель для электрических проводов
- DE Wasserdichtes T-Stück für Elektroleitungen
- HU Vízálló T-idom és csatló elektromos vezetékhez



WZL-4	tworzywo, plastic, пластмасса, Kunststoff, anyag	czarny, black, черный, schwarz, fekete	5902801016189
-------	---	--	---------------





PL Kostka z osłonką izolacyjną do opraw
 EN Connection block with insulation sleeve for fixtures
 RU Клеммная колодка с крышкой для светильников
 DE Isolierte Kabelsteckklemme für Leuchten
 HU Sorkapocs szigetelő borítással, keretekhez



LZ-KOI2KO-10	czarny, black, черный, schwarz, fekete	5901867199027
--------------	--	---------------



PL Złączki zaciskowe - elastyczne
 EN Flexible connection terminals
 RU Зажимные муфты - гибкие
 DE Lüsterklemmen - flexibel
 HU Roppantógyűrűs rugalmas csatlakozók

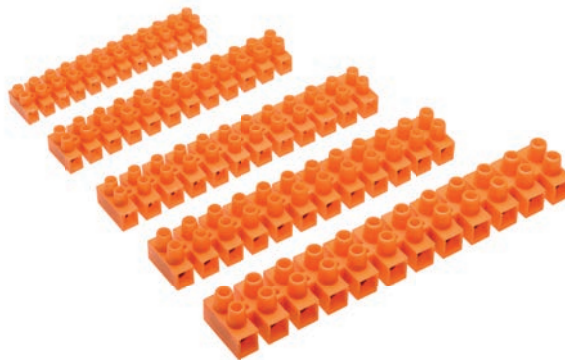

LZ-25MM00-00	24 A	polietylen полиэтилен Polyethylen polietilén	16 g	10	5908231331922
LZ-40MM00-00	32 A		26 g		5908231331939
LZ-60MM00-00	41 A		32 g		5908231331946
LZ-100MM00-00	57 A		46 g		5908231331892
LZ-160MM00-00	76 A		65 g		5908231331908
LZ-250MM00-00	101 A		96 g		5908231331915





- PL Oslona sufitowa na kostkę elektryczną
- EN Ceiling cover for connection block
- RU Потолочная крышка для клеммной колодки
- DE Deckenschutzverkleidung für Kabelsteckklemme
- HU Plafonkeret elektromos sorkapocsra



AE-CANOPY-10	biały, white, белый, weiß, fehér	5901867124234
--------------	----------------------------------	---------------

- PL Statyw do opraw halogenowych, ledowych
- EN Halogen / LED fixture stand
- RU Штатив для галогенных и светодиодных светильников
- DE Ständer für Halogen- und LED-Lampen
- HU Állvány halogén és LED lámpatestek részére

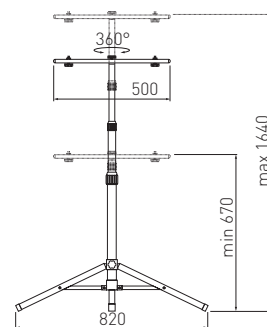

Installation fittings



OH-ST2500-23	stal, steel, сталь, Stahl, acél	żółty, yellow, желтый, gelb, sárga	2000 g	5908231360663
--------------	------------------------------------	---------------------------------------	--------	---------------



PL Kabel z wtyczką i włącznikiem, 2 m
 EN Cables with plug & switch, 2 m
 RU Кабели с вилкой и выключателем 2 м
 DE Kabel mit Stecker und Schalter, 2 m
 HU Kábelek dugóval és kapcsolóval 2 m



LD-KABE2M-00	2 m	5908231335265
LD-KABE2M-10		5902801004018



PL Kabel z wtyczką
 EN Cables with plug
 RU Кабели с вилкой
 DE Kabel mit Stecker
 HU Kábelek dugóval



KB-W310HUG-20	1,5 m	5908231385871
KB-W313HUG-20	3 m	5902801003899



PL Zapłonnik
 EN Starter
 RU Стартер
 DE Starter
 HU Indító



INFO







OS-STA422-00	4-22 W, 230 V AC	5908231332578
OS-STA465-00	4-65 W, 230 V AC	5908231332585
OS-STA480-00	4-80 W, 230 V AC	5901867122841

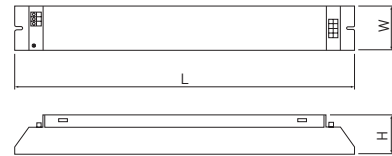

PL Stateczniki elektroniczne
EN Electronic drivers
RU Электронный балласт
DE Elektronisches Vorschaltgerät
HU Elektronikus elôtét







			LxWxH	
OS-SEL118-00	1 x 18 W / T8	70 g	210 x 28 x 30 mm	5908231332417
OS-SEL136-00	1 x 36 W / T8	78 g	210 x 28 x 30 mm	5908231332424
OS-SEL158-00	1 x 58W/T8	86 g	210 x 28 x 30 mm	5908231332431
OS-SEL218-00	2 x 18 W / T8	107 g	275 x 28 x 30 mm	5908231332448
OS-SEL236-00	2 x 36 W / T8	108 g	275 x 28 x 30 mm	5908231332455
OS-SEL258-00	2 x 58 W / T8	123 g	275 x 28 x 30 mm	5908231332462
OS-SEL414-00	4 x 14 W / T5	255 g	301 x 34 x 31 mm	5908231339768
OS-SEL418-00	4 x 18 W / T8	227 g	301 x 34 x 31 mm	5908231336040
OS-SEL418-HV	4 x 18 W / T8	225 g	301 x 34 x 31 mm	5901867101006

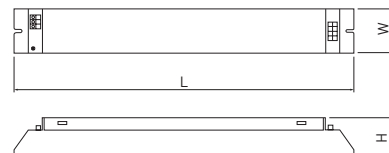

PL Stateczniki elektroniczne
EN Electronic drivers
RU Электронный балласт
DE Elektronisches Vorschaltgerät
HU Elektronikus elôtét



			LxWxH	
OS-SEL236-ZHQ	2 x 36 W / T8	70 g	210 x 28 x 30 mm	5902801038174
OS-SEL418-ZHQ	4 x 18 W / T8	78 g		5902801038167









OŚWIETLENIE MEBLOWE
FURNITURE LIGHTING
ОСВЕЩЕНИЕ МЕБЕЛИ
MÖBEL BELEUCHTUNG
BÚTOR VILÁGÍTÁS

Oświetlenie meblowe
Furniture lighting
Освещение мебели
Möbel beleuchtung
Bútor világítás

266





PL Mini lampka wtykowa LED
EN Mini plug-in LED lamp
RU Светодиодный мини-светильник в розетку
DE Mini-LED-Steckdosenleuchte
HU Bedugható mini LED lámpa

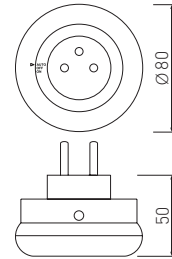

LD-ML1000-00	1W	4000 K	50 lm	tworzywo, plastic, пластмасса, Kunststoff, plasztik	78 g	5902801023392



PL Mini lampka wtykowa LED
EN Mini plug-in LED lamp
RU Светодиодный мини-светильник в розетку
DE Mini-LED-Steckdosenleuchte
HU Bedugható mini LED lámpa

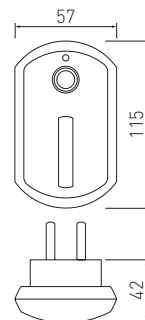

LD-ML2000-00	1W	4000 K	50 lm	tworzywo, plastic, пластмасса, Kunststoff, plasztik	72 g	5902801023392



PL Mini lampka wtykowa LED
EN Mini plug-in LED lamp
RU Светодиодный мини-светильник в розетку
DE Mini-LED-Steckdosenleuchte
HU Bedugható mini LED lámpa

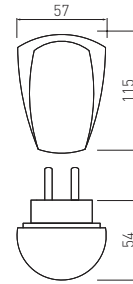

LD-ML3000-00	1W	● 4000 K	50 lm	tworzywo, plastic, пластмасса, Kunststoff, plasztik	37 g	5902801023453



PL Mini lampka wtykowa LED
EN Mini plug-in LED lamp
RU Светодиодный мини-светильник в розетку
DE Mini-LED-Steckdosenleuchte
HU Bedugható mini LED lámpa

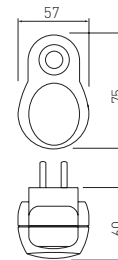

LD-ML4000-00	1W	● 4000 K	50 lm	tworzywo, plastic, пластмасса, Kunststoff, plasztik	52 g	5902801023484



PL Mini lampka wtykowa LED
EN Mini plug-in LED lamp
RU Светодиодный мини-светильник в розетку
DE Mini-LED-Steckdosenleuchte
HU Bedugható mini LED lámpa

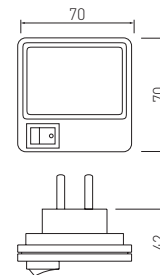

LD-ML5000-00	1W	● 4000 K	50 lm	tworzywo, plastic, пластмасса, Kunststoff, plasztik	46 g	5902801023514



PL Taśma LED FLASH
EN LED strip FLASH
RU Светодиодная лента FLASH
DE LED-Band FLASH
HU LED szalag FLASH



LD-3528-300-20-ZB	12 VDC 4,8 W/m	300 lm/m	● 6500 K	20	120°	8	60/m	5	5901867152053
LD-3528-300-20-NE			● 5000 K						5901867162083
LD-3528-300-20-NE4P			● 4000 K						5902801224911
LD-3528-300-20-CB			● 3200 K						5901867152022
LD-3528-300-20-NI			-						niebieski, blue, синий, blau, kék
LD-3528-300-65-ZB	12 VDC 4,8 W/m	280 lm/m	● 6500 K	65					5901867152114
LD-3528-300-65-CB			● 3200 K						5901867152084
LD-3528-600-20-ZB	12 VDC 9,6 W/m	550 lm/m	● 6500 K	20	120°	8	120/m	2,5	5901867152251
LD-3528-600-20-CB			● 3200 K						5901867152312
LD-3528-600-65-ZB	12 VDC 9,6 W/m	520 lm/m	● 6500 K	65					5901867152374
LD-3528-600-65-CB			● 3200 K						5901867152343
LD-2835-300-20-ZB	12 VDC 6 W/m	750 lm/m	● 6500 K	20	120°	8	60/m	5	5901867152640
LD-2835-300-20-NE			● 5000 K						5901867162021
LD-2835-300-20-NE4P			● 4000 K						5902801224980
LD-2835-300-20-CB			● 3200 K						5901867152619
LD-2835-300-65-ZB	12 VDC 6 W/m	700 lm/m	● 6500 K	65					5901867152701
LD-2835-300-65-CB			● 3200 K						5901867152671
LD-5050-300-20-ZB	12 VDC 14,4 W/m	900 lm/m	● 6500 K	20	120°	10	60/m	5	5901867152497
LD-5050-300-20-CB			● 3200 K						5901867152466
LD-5050-300-65-ZB	12 VDC 14,4 W/m	850 lm/m	● 6500 K	65					5901867152558
LD-5050-300-65-CB			● 3200 K						5901867152527
LD-5630-300-20-ZB	12 VDC 16 W/m	1750 lm/m	● 6500 K	20	120°	10	60/m	5	5901867152763
LD-5630-300-20-CB			● 3200 K						5901867152732
LD-5630-300-65-ZB	12 VDC 16 W/m	1700 lm/m	● 6500 K	65					5901867152824
LD-5630-300-65-CB			● 3200 K						5901867152794
LD-RGB-150-20	12 VDC 7,2 W/m	450 lm/m	● RGB	20	120°	10	30/m	10	5901867152404
LD-RGB-150-65			65	5901867152435					



PL Taśma LED FLASH 50 m
EN LED strip FLASH 50 m
RU Светодиодная лента FLASH 50 m
DE LED-Band FLASH 50 m
HU LED szalag FLASH 50 m



LD-3528-300-20-CB-50	12 VDC 4,8 W/m	300 lm/m	● 3200 K	20	120°	50 m	8 mm	60/m	5	5901867172082
LD-3528-300-20-NE4P-50			● 4000 K							5902801252150
LD-3528-300-20-NE-50			● 5000 K							5901867172105
LD-3528-300-20-ZB-50			● 6500 K							5901867172099
LD-2835-300-20-ZB-50	12 VDC 6 W/m	750 lm/m	● 6500 K	20	120°	50 m	8 mm	60/m	5	5901867195142
LD-2835-300-20-NE-50			● 5000 K							5902801006784
LD-2835-300-20-NE4P-50			● 4000 K							5902801225000
LD-2835-300-20-CB-50			● 3200 K							5901867195128



PL Taśma LED BIS
EN LED strip BIS
RU Светодиодная лента BIS
DE LED-Band BIS
HU LED szalag BIS



LD-3528B-300-20-CB	12 VDC 4,8 W/m	300 lm/m	● 3200 K	20	120°	5	8	60/m	5	100	5902801011283
LD-3528B-300-20-ZB			● 6500 K								5902801011290
LD-3528B-300-65-CB	12 VDC 4,8 W/m	280 lm/m	● 3200 K	65	120°	5	8	60/m	5	50	5902801011306
LD-3528B-300-65-ZB			● 6500 K								5902801011313



PL Profil GLAX nakładany, mikro
 EN GLAX profile surface mounted, micro
 RU Профиль GLAX накладной, микро
 DE GLAX micro Aufsatzprofil
 HU GLAX profil, felrakható, micro

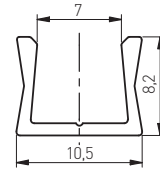
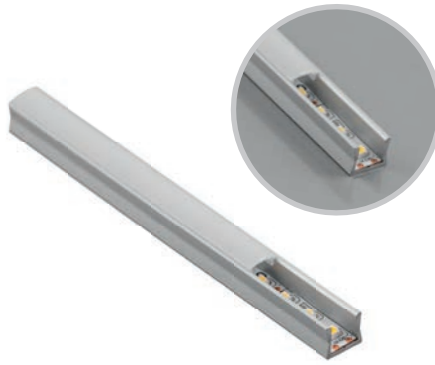

	 L m				
PA-GLAXMICNK-AL	2	profil, profile, профиль, Profile, profilok	srebrny silver серебристый silber ezüst	aluminium aluminium алюминий Aluminium aluminium	5902801281549
PA-GLAXMICNK3M-AL	3				5902801281495
PA-OSMLGLAXMIC-00	2	osłonka mikro, cover micro, крышка микро, Abdeckung micro, Takaró micro	mleczna, frosted, молочная, milchig, tejszínű	tworzywo, plastic, пластмасса, Kunststoff, plasztik	-
PA-OSMLGLAXMIC3M-00	3				-

Ostonki / Covers / Крышки / Abdeckungen / Takarók:



PA-OSMLGLAXMIC-00



PA-OSMLGLAXMIC3M-00



PL Profil GLAX nakładany mini
EN GLAX profile mini surface mounted
RU Профиль GLAX накладной мини
DE GLAX mini Aufsatzprofil
HU GLAX profil, felrakható, mini

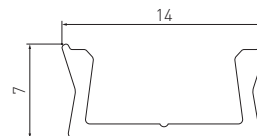

Taśma LED max 10 mm szerokości
LED strip width max 10 mm
Ширина светодиодной ленты не более 10 мм
LED-Streifen max. 10 mm breit
Max 10mm szélességű LED szallag

PA-GLAXMNK-AL	2	profil, profile, профиль, Profile, profilok	srebrny silver серебристый silber ezüst	aluminium aluminium алюминий Aluminium alumínium	5902801010316	
PA-GLAXMNK3M-AL	3				5902801010781	
PA-OSMLGLAXM-00	2	oslonka mini, cover mini, крышка мини, Abdeckung mini, Takaró mini	mleczna, frosted, молочная, milchig, tejszínű	tworzywo, plastic, прозрачная, Kunststoff, plasztik	5902801024023	
PA-OSMLGLAXM3M-00	3				5902801024047	
PA-OSTRGLAXM-00	2		transparentna, transparent, прозрачная, durchsichtig, átlátszó		5901867112002	
PA-OSTRGLAXM3M-00	3				5901867197627	
PA-OSMLGLAXMK-00	2		oslonka kwadratowa, cover square, крышка квадратная, quadratische Abdeckung, Takaró szögletes		mleczna, frosted, молочная, milchig, tejszínű	5902801040511
PA-OSMLGLAXMO-00		oslonka okrągła, cover round, крышка круглая, runde Abdeckung, Takaró kerek	5902801222702			
PA-ZASGLAXMNK-00	-	zaślepka standard, end cap standard, заглушка стандартная, Standard- Endkappen, Végzáró	szary, grey, серый, grau, szürke	ABS	5902801024061	
PA-ZASGLAXMNKK-00	-	zaślepka kwadratowa, end cap square, заглушка квадратная, quadratische Endkappen, Szögletes végzáró			5902801222962	
PA-ZASGLAXMNKO-00	-	zaślepka okrągła, end cap round, заглушка круглая, runde Abdeckung, Takaró kerek			5902801222986	

Oslonki / Covers / Крышки / Abdeckungen / Takarók:



PA-OSMLGLAXM-00
PA-OSMLGLAXM3M-00

PA-OSTRGLAXM-00
PA-OSTRGLAXM3M-00

PA-OSMLGLAXMO-00

PA-OSMLGLAXMK-00

Zaślepki / End caps / Заглушки / Endkappen / Végzárók:

PA-ZASGLAXMNK-00

PA-ZASGLAXMNKK-00

PA-ZASGLAXMNKO-00

PL Profil GLAX nakładany
EN GLAX profile surface mounted
RU Профиль GLAX накладной
DE GLAX Aufsatzprofil
HU GLAX profil, felrakható

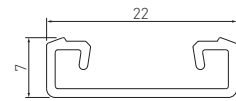

PA-GLAXNK-AL	2	profil, profile, профиль, Profile, profilok	srebrny silver серебристый silber ezüst	aluminium aluminium алюминий Aluminium aluminium	5902801257704
PA-GLAXNK3M-AL	3				5901867196606
PA-ZASGLAXNK-00	-	zaślepka, end cap, заглушка, Endkappen, Végzáró	szary, grey, серый, grau, szürke	ABS	5901867136411

Ostonki / Covers / Крышки / Abdeckungen / Takarók:

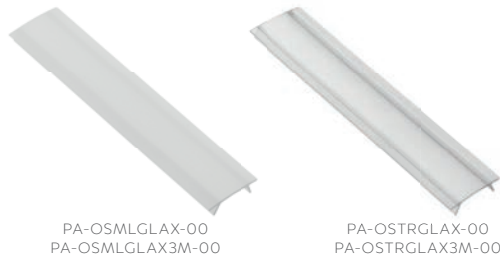

Zaślepki / End caps / Заглушки / Endkappen / Végzárók:



PL Profil GLAX nakładany mini, wysoki
EN Profile GLAX surface mounted mini, high
RU Профиль GLAX накладной мини, высокий
DE Aufbauprofil GLAX mini, hoch
HU GLAX profil, felrakható, mini, magas

Brak widocznych punktów świetlnych
Taśma LED max 10 mm szerokości
No visible points of light
LED strip width max 10 mm
Нет видимых точек света
Ширина светодиодной ленты не более 10 мм
Keine sichtbaren Lichtpunkte
LED-Streifen max. 10 mm breit
Nem látható fénypontok
Max 10mm szélességű LED szallag

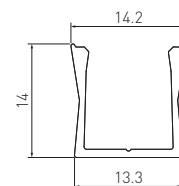
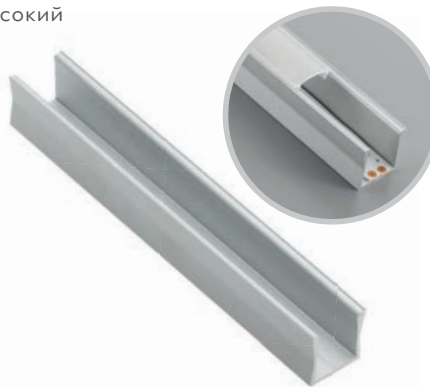

PA-GLAXMNKW-AL	2	profil, profile, профиль, Profile, profilok	srebrny, silver, серебристый silber, ezüst	aluminium, aluminium алюминий, Aluminium aluminium	5902801259104
PA-OSMLGLAXM-00	2	osłonka mini, cover mini, крышка мини, Abdeckung mini, Takaró mini	mleczna, frosted, молочная, milchig, tejszínű	tworzywo, plastic, пластмасса, Kunststoff, plasztik	5902801024030
PA-OSTRGLAXM-00		transparentna, transparent, прозрачная, durchsichtig, átlátszó	5902801024023		
PA-ZASGLAXMNKW-00	-	zaślepka, end cap, заглушка, Endkappen, Végzáró	szary, grey, серый, grau, szürke	ABS	5902801223181

Ostonki / Covers / Крышки / Abdeckungen / Takarók:



Zaślepki / End caps / Заглушки / Endkappen / Végzárók:



PL Profil GLAX wpuszczany, mikro
EN GLAX profile recessed, micro
RU Профиль GLAX врезной, микро
DE Einlassprofil GLAX, hoch, micro
HU GLAX profil, beereszthető, micro

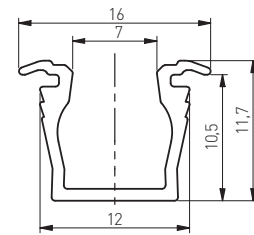

PA-GLAXMIC-AL	2	profil, profile, профиль, Profile, profilok	srebrny silver серебристый silber ezüst	aluminium aluminium алюминий Aluminium aluminium	5902801281600
PA-GLAXMIC3M-AL	3				5902801281839
PA-OSMLGLAXMIC-00	2	oslonka mikro, cover micro, крышка микро, Abdeckung micro, Takaró micro	mleczna, frosted, молочная, milchig, tejszínű	tworzywo, plastic, пластмасса, Kunststoff, plasztik	-
PA-OSMLGLAXMIC3M-00	3				-

Oslonki / Covers / Крышки / Abdeckungen / Takarók:



PA-OSMLGLAXMIC-00

PA-OSMLGLAXMIC3M-00

PL Profil GLAX wpuszczany
EN Profile GLAX recessed
RU Профиль LED GLAX врезной
DE GLAX Einlassprofil
HU GLAX profil, beereszthető

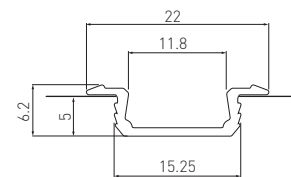

PA-GLAX-AL	2	profil, profile, профиль, Profile, profilok	srebrny, silver, серебристый silber, ezüst	aluminium, aluminium алюминий, Aluminium aluminium	5902801257735
PA-GLAX3M-AL	3				5902801257711
PA-OSMLGLAX-00	2	oslonka, cover, крышка, Abdeckungen, Takarók	mleczna, frosted, молочная, milchig, tejszínű	tworzywo, plastic, пластмасса, Kunststoff, plasztik	5901867111999
PA-OSMLGLAX3M-00	3				5901867197610
PA-OSTRGLAX-00	2		transparentna, transparent, прозрачная, durchsichtig, átlátszó		5901867112002
PA-OSTRGLAX3M-00	3				5901867197627
PA-ZASGLAX-00	-	zaśleпка, end cap, заглушка, Endkappen, Végzáró	szary, grey, серый, grau, szürke	ABS	5901867111982

Oslonki / Covers / Крышки / Abdeckungen / Takarók:

Zaślepi / End caps / Заглушки / Endkappen / Végzárók:



PA-OSMLGLAXM-00

PA-OSTRGLAXM-00

PA-ZASGLAX-00

PL Profil GLAX wpuszczany, wysoki
EN Profile GLAX recessed, high
RU Профиль LED GLAX врезной
DE Einlassprofil GLAX, hoch
HU GLAX profil, beereszthető

Brak widocznych punktów świetlnych
Taśma LED max 10 mm szerokości
No visible points of light
LED strip width max 10 mm
Нет видимых точек света
Ширина светодиодной ленты не более 10 мм
Keine sichtbaren Lichtpunkte
LED-Streifen max. 10 mm breit
Nem látható fénypontok
Max 10mm szélességű LED szallag

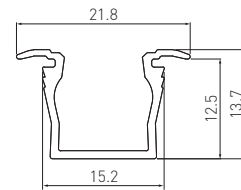

PA-GLAXMW-AL	2	profil, profile, профиль, Profile, profilok	srebrny, silver, серебристый silber, ezüst	aluminium, aluminium алюминий, Aluminium aluminium	5902801259111
PA-OSMLGLAXM-00	2	oslonka mini, cover mini, крышка мини, Abdeckung mini, Takaró mini	mleczna, frosted, молочная, milchig, tejszínű	tworzywo, plastic, пластмасса, Kunststoff, plasztik	5902801024030
PA-OSMLGLAXMK-00		oslonka kwadratowa, cover square, крышка квадратная, quadratische Abdeckung, Takaró szögletes	transparentna, transparent, прозрачная, durchsichtig, átlátszó		5902801040511
PA-OSTRGLAXM-00		oslonka mini, cover mini, крышка мини, Abdeckung mini, Takaró mini	szary, grey, серый, grau, szürke		5902801024023
PA-ZASGLAXMW-00	-	zaślepka standard, end cap standard, заглушка стандартная, Standard-Endkappen, Végzáró	szary, grey, серый, grau, szürke	ABS	5902801040481
PA-ZASGLAXMWK-00	-	zaślepka kwadratowa, end cap square, заглушка квадратная, quadratische Endkappen, Szögletes végzáró			5902801040559

Oslonki / Covers / Крышки / Abdeckungen / Takarók:



PA-OSMLGLAXM-00 PA-OSTRGLAXM-00 PA-OSMLGLAXMK-00

Zaślepki / End caps / Заглушки / Endkappen / Végzárók:



PA-ZASGLAXMW-00 PA-ZASGLAXMWK-00

PL Profil GLAX kątowy
EN GLAX corner profile
RU Профиль GLAX угловой
DE Aluprofil für LED-Bänder
HU Alumínium szögprofil led szalagok részére

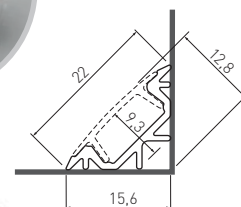

PA-GLAXKT-AL	2	profil, profile, профиль, Profile, profilok	srebrny, silver, серебристый silber, ezüst	aluminium, aluminium алюминий, Aluminium aluminium	5902801257766
PA-GLAXKT3M-AL	3				5902801257728
PA-OSMLGLAX-00	2	oslonka, cover, крышка, Abdeckungen, Takarók	mleczna, frosted, молочная, milchig, tejszínű	tworzywo, plastic, пластмасса, Kunststoff, plasztik	5901867111999
PA-OSMLGLAX3M-00	3				5901867197610
PA-OSTRGLAX-00	3		transparentna, transparent, прозрачная, durchsichtig, átlátszó		5901867112002
PA-OSTRGLAX3M-00	2		5901867197627		
PA-ZASGLAXKT-00	-	zaślepka, end cap, заглушка, Endkappen, Végzáró	szary, grey, серый, grau, szürke	ABS	5901867136428

Oslonki / Covers / Крышки / Abdeckungen / Takarók:



PA-OSMLGLAX-00 PA-OSMLGLAX3M-00 PA-OSTRGLAX-00 PA-OSTRGLAX3M-00

Zaślepki / End caps / Заглушки / Endkappen / Végzárók:



PA-ZASGLAXKT-00

PL Profil GLAX kątowy, nakładany
EN GLAX aluminium corner profile – surface mounted
RU Профиль LED GLAX угловой, накладной
DE Aufbau-Winkelprofil I GLAX
HU Glax sarokprofil, felrakható

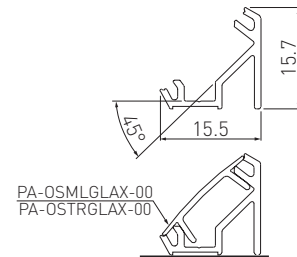

		L m	i			
PA-GLAXNKKT-AL	2	profil, profile, профиль, Profile, profilok	srebrny, silver, серебристый silber, ezüst	aluminium, aluminium алюминий, Aluminium aluminium	5902801258879	
PA-GLAXNKKT3M-AL	3				5902801258671	
PA-OSMLGLAX-00	2	oslonka mini, cover mini, крышка мини, Abdeckung mini, Takaró mini	mleczna, frosted, молочная, milchig, tejszínű	tworzywo, plastic, пластмасса, Kunststoff, plasztik	5901867111999	
PA-OSMLGLAX3M-00	3				5901867197610	
PA-OSTRGLAX-00	2		transparentna, transparent, прозрачная, durchsichtig, átlátszó		5901867112002	
PA-OSTRGLAX3M-00	3		5901867197627			
PA-OSMLGLAXT-00	2	oslonka trójkątna, cover triangular, крышка треугольная, dreieckige Abdeckung, Háromszögű takaró	mleczna, frosted, молочная, milchig, tejszínű		5902801040627	
PA-ZASGLAXNKKT-00	-	zaślepka standard, end cap standard, заглушка стандартная, Standard- Endkappen, Végzáró	szary, grey, серый, grau, szürke	ABS	5902801222900	
PA-ZASGLAXNKKT-00	-	zaślepka trójkątna, end cap triangular, заглушка треугольная, dreieckige Endkappen, Háromszögű végzáró			5902801223136	

Oslonki / Covers / Крышки / Abdeckungen / Takarók:



PA-OSMLGLAX-00
PA-OSMLGLAX3M-00

PA-OSTRGLAX-00
PA-OSTRGLAX3M-00

PA-OSMLGLAXT-00

Zaślepki / End caps / Заглушки /
Endkappen / Végzárók:



PA-ZASGLAXNKKT-00

PA-ZASGLAXNKKT-00

PL Profil GLAX z radiatorem
EN Profile GLAX with heatsink
RU Профиль GLAX с радиатором
DE Profil GLAX mit Kühler
HU Profil GLAX hűtőbordával

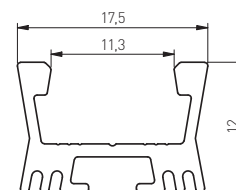

PA-GLAXRAD-AL	2	profil, profile, профиль, Profile, profilok	srebrny, silver, серебристый silber, ezüst	aluminium, aluminium алюминий, Aluminium aluminium	5902801281877
PA-OSMLGLAXSO-00	2	oslonka soczewka, cover lenticular, крышка линзовидный, Abdeckung "Linse", lencse fedél	transparentna, transparent, прозрачная, durchsichtig, átlátszó	tworzywo, plastic, пластмасса, Kunststoff, plasztik	-

Oslonki / Covers / Крышки / Abdeckungen / Takarók:



PA-OSMLGLAXSO-00

PL Profil GLAX wieńcowy
EN Rim profile GLAX
RU Профиль GLAX, торцевой
DE Schrankunterbodenprofil GLAX
HU Glax koszorúér profil

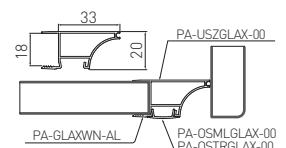

PA-GLAXWN-AL	2	profil, profile, профиль, Profile, profilok	srebrny, silver, серебристый silber, ezüst	aluminium, aluminium алюминий, Aluminium aluminium	5902801258619
PA-OSMLGLAX-00		oslonka, cover, крышка, Abdeckungen, Takarók	mleczna, frosted, молочная, milchig, tejszínű	tworzywo, plastic, пластмасса, Kunststoff, plasztik	5901867111999
PA-OSTRGLAX-00		transparentna, transparent, прозрачная, durchsichtig, átlátszó	tworzywo, plastic, пластмасса, Kunststoff, plasztik	5901867112002	
PA-USZGLAX-00N	10	uszczelka, cord gasket, уплотнитель, Dichtung, Elzáró	czarny, black, черный, schwarz, fekete	EPDM	5902801021039

Oslonki / Covers / Крышки / Abdeckungen / Takarók:

Uszczelka / Cord gasket / Уплотнитель / Dichtung / Elzáró:



PA-OSMLGLAX-00



PA-OSTRGLAX-00



PA-USZGLAX-00N

ø2,5

PL Profil GLAX półkowy mini
EN Shelf profile GLAX mini
RU Профиль GLAX полочный мини
DE Profil GLAX mini für Glaskantenbeleuchtung
HU Glax polc profil mini

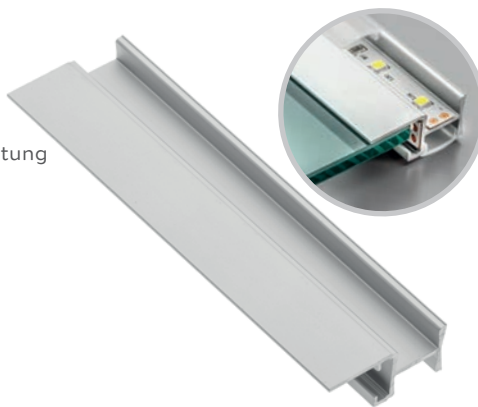

Możliwość zastosowania 3 taśm LED
Possibility of using 3 LED strips
Возможность использования 3 светодиодных лент
Einsatzmöglichkeit von 3 LED-Streifen
3 LED szallag használható

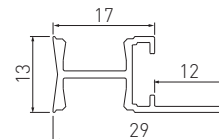
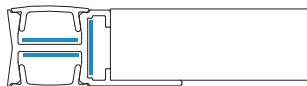

Folder	L m	i	Material	Material	Barcode
PA-GLAXMPK-AL	2	profil, profile, профиль, Profile, profilok	srebrny, silver, серебристый silber, ezüst	aluminium, aluminium алюминий, Aluminium alumínium	5902801258633
PA-OSMLGLAXM-00			mleczna, frosted, молочная, milchig, tejszínű	tworzywo, plastic, пластмасса, Kunststoff, plasztik	5902801024030
PA-OSTRGLAXM-00			transparentna, transparent, прозрачная, durchsichtig, átlátszó		5902801024023

Oslonki / Covers / Крышки / Abdeckungen / Takarók:

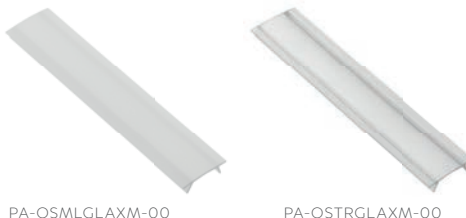

PA-OSMLGLAXM-00

PA-OSTRGLAXM-00

PL Profil GLAX drążkowy
EN GLAX rail profile
RU Профиль-штанга GLAX
DE Kleiderstangenprofil GLAX
HU Glax mándlírud profil

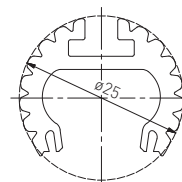

Możliwości montażu jako, Assembly options as, Варианты сборки, Befestigungsmöglichkeiten als, Használható mint

- drążek w szafie
- rod in the closet
- стержень в шкафу
- Kleiderstange
- Mándlírud
- oprawa zwieszana
- suspended luminaire
- подвесной светильник
- Hängeleuchte
- Felfüggesztett lámpatest

Folder	L m	i	Material	Material	Barcode
PA-GLAXDR-AL	2	profil, profile, профиль, Profile, profilok	srebrny, silver, серебристый silber, ezüst	aluminium, aluminium алюминий, Aluminium alumínium	5902801258954
PA-OSMLGLAX-00			mleczna, frosted, молочная, milchig, tejszínű	tworzywo, plastic, пластмасса, Kunststoff, plasztik	5901867111999
PA-OSTRGLAX-00			transparentna, transparent, прозрачная, durchsichtig, átlátszó		5901867112002
PA-ZASGLAXDR-00	-	zaślepka, end cap, заглушка, Endkappen, Végzáró	szary, grey, серый, grau, szürke	ZnAl	5902801223266
PA-ROZGLAX-53	-	rozetka, rail socket, монтажный крепеж, Schrankrohrlager, Gyűrű			5902801018046
PA-ZAWGLAXDR-00	1,5	zawieszka, hanger, подвес для профиля, Aufhänger, Fügő akasztó	chrom, chrome, хром, Chrom, króm	stal, steel, сталь, Stahl, acél	5902801046506

Oslonki / Covers / Крышки / Abdeckungen / Takarók:



PA-OSMLGLAX-00

PA-OSTRGLAX-00

Zaślepka / End cap / Заглушка / Endkappen / Végzáró



PA-ZASGLAXDR-00

Rozetka, Rail socket, Монтажный крепеж, Schrankrohrlager, Gyűrű



PA-ROZGLAX-53

Zawieszka / Hanger / Подвес для профиля / Aufhänger / Fügő akasztó



PA-ZAWGLAXDR-00

PL Profil GLAX kątowy, nabijany, jednostronny
 EN GLAX aluminium edge profile – single-sided
 RU Профиль LED GLAX торцевой, односторонний
 DE GLAX Winkelauftriebprofil, einseitig
 HU GLAX sarokprofil, felpattintható, egyoldalú

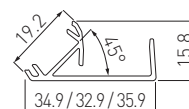

	BOARD mm	L m	i			
PA-GLAXNBJ2M16-AL	16	2	profil, profile, профиль, Profile, profilok	srebrny, silver, серебристый silber, ezüst	aluminium, aluminium алюминий, Aluminium aluminium	5902801257827
PA-GLAXNBJ3M16-AL	16	3				5902801257834
PA-GLAXNBJ3M-AL	18	3				5902801258626
PA-GLAXNBJ2M19-AL	19	2				5902801257599
PA-GLAXNBJ3M19-AL	19	3				5902801257605
PA-OSMLGLAX-00	-	2	osłonka, cover, крышка, Abdeckungen, Takarók	mleczna, frosted, молочная, milchig, tejszínű	tworzywo, plastic, пластмасса, Kunststoff, plasztik	5901867111999
PA-OSMLGLAX3M-00	-	3				5901867197610
PA-OSTRGLAX-00	-	3		transparentna transparent прозрачная durchsichtig, átlátszó		5901867112002
PA-OSTRGLAX3M-00	-	2				5901867197627

Ostonki / Covers / Крышки / Abdeckungen / Takarók:



PA-OSMLGLAX-00
PA-OSMLGLAX3M-00



PA-OSTRGLAX-00
PA-OSTRGLAX3M-00



- PL Profil GLAX, kątowy, nabijany, jednostronny (do wypełnienia obrzeżem)
 EN GLAX aluminium edge profile – single-sided (option to fill with matching edge banding)
 RU Профиль LED GLAX торцевой, кромочный, односторонний
 DE GLAX Winkelauftriebprofil, einseitig (mit Randprofil verfüllt)
 HU GLAX sarokprofil, felpattintható, egyoldalú (élzárással való kitöltésre)

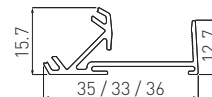

	BOARD mm	L m				
PA-GLAXNBW2M16-AL	16	2	profil, profile, профиль, Profile, profilok	srebrny, silver, серебристый siber, ezüst	aluminium, aluminium алюминий, Aluminium aluminium	5902801259029
PA-GLAXNBW3M16-AL	16	3				5902801259036
PA-GLAXNBW3M-AL	18	3				5902801258657
PA-GLAXNBW2M19-AL	19	2				5902801258961
PA-GLAXNBW3M19-AL	19	3				5902801258978
PA-OSMLGLAX-00	-	2	ostonka, cover, крышка, Abdeckungen, Takarók	mleczna, frosted, молочная, milchig, tejszínű	tworzywo, plastic, пластмасса, Kunststoff, plasztik	5901867111999
PA-OSMLGLAX3M-00	-	3		5901867197610		
PA-OSTRGLAX-00	-	3		transparentna transparent прозрачная durchsichtig, átlátszó		5901867112002
PA-OSTRGLAX3M-00	-	2		5901867197627		

Ostonki / Covers / Крышки / Abdeckungen / Takarók:



PA-OSMLGLAX-00
PA-OSMLGLAX3M-00



PA-OSTRGLAX-00
PA-OSTRGLAX3M-00

PL Profil GLAX kątowy, nabijany, dwustronny
 EN GLAX aluminium edge profile – double sided
 RU Профиль LED GLAX торцевой, двухсторонний
 DE GLAX Winkelauftriebprofil, doppelseitig
 HU GLAX sarokprofil, felpattintható, kétoldalú



PA-GLAXNBD2M16-AL	16	2	profil, profile, профиль, Profile, profilok	srebrny, silver, серебристый silber, ezüst	aluminium, aluminium алюминий, Aluminium aluminium	5902801259005
PA-GLAXNBD3M16-AL	16	3				5902801259012
PA-GLAXNBD3M-AL	18	3				5902801258640
PA-GLAXNBD2M19-AL	19	2				5902801257629
PA-GLAXNBD3M19-AL	19	3				5902801257650
PA-OSMLGLAX-00	-	2	osłonka, cover, крышка, Abdeckungen, Takarók	mleczna, frosted, молочная, milchig, tejszínű	tworzywo, plastic, пластмасса, Kunststoff, plasztik	5901867111999
PA-OSMLGLAX3M-00	-	3		5901867197610		
PA-OSTRGLAX-00	-	3		transparentna transparent прозрачная durchsichtig, átlátszó		5901867112002
PA-OSTRGLAX3M-00	-	2		5901867197627		

Oslonki / Covers / Крышки / Abdeckungen / Takarók:



PA-OSMLGLAX-00
PA-OSMLGLAX3M-00



PA-OSTRGLAX-00
PA-OSTRGLAX3M-00



- PL Profil GLAX kątowy, nabijany, dwustronny (do wypełnienia obrzeżem)
 EN GLAX aluminium edge profile – double sided (option to fill with matching edge banding)
 RU Профиль LED GLAX торцевой, кромочный, двухсторонний
 DE GLAX Winkelaufreibprofil, doppelseitig (mit Randprofil verfüllt)
 HU GLAX sarokprofil, felpattintható, kétoldalú (élzárással való kitöltésre)



	BOARD mm	L m	i				
PA-GLAXNBDW2M16-AL	16	2	i	profil, profile, профиль, Profile, profilok	srebrny, silver, серебристый silber, ezüst	aluminium, aluminium алюминий, Aluminium aluminium	5902801259043
PA-GLAXNBDW3M16-AL	16	3					5902801259050
PA-GLAXNBDW3M-AL	18	3					5902801258664
PA-GLAXNBDW2M19-AL	19	2					5902801257681
PA-GLAXNBDW3M19-AL	19	3					5902801257803
PA-OSMLGLAX3M-00	-	3	i	oslonka, cover, крышка, Abdeckungen, Takarók	mleczna, soft white, белый матовый, milchig, tejszínű transparentna, transparent, прозрачная, durchsichtig, átlátszó	tworzywo, plastic, пластмасса, Kunststoff, plasztik	5901867197610
PA-OSTRGLAX3M-00	-						5901867197627

Oslonki / Covers / Крышки / Abdeckungen / Takarók:



PA-OSMLGLAX3M-00



PA-OSTRGLAX3M-00

- PL Profil GLAX kątowy, nabijany, wąski, jednostronny
 EN Corner profile GLAX, one-sided, edge mounted
 RU Профиль GLAX угловой, накладной, узкий, односторонний
 DE Winkelprofil GLAX, zum Aufschieben auf Plattenkante, einseitig, schmal
 HU GLAX LED Sarok Profil egyoldalú, keskeny

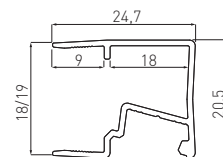

	L m	i							
PA-GLAXMNBW3M-AL	3	i	profil, profile, профиль, Profile, profilok	srebrny, silver, серебристый silber, ezüst	aluminium, aluminium алюминий, Aluminium aluminium	5902801259128			
PA-OSMLGLAXM3M-00						oslonka mini, cover mini, крышка мини, Abdeckung mini, Takaró mini	mleczna, frosted, молочная, milchig, tejszínű	tworzywo, plastic, пластмасса, Kunststoff, plasztik	5902801024054
PA-OSTRGLAXM3M-00						transparentna, transparent, прозрачная, durchsichtig, átlátszó	5902801024047		

Oslonki / Covers / Крышки / Abdeckungen / Takarók:



PA-OSMLGLAXM3M-00



PA-OSTRGLAXM3M-00

PL Profil GLAX kątowy, nabijany, wąski, dwustronny
 EN Corner profile GLAX, narrow, two-sided
 RU Профиль GLAX угловой, накладной, узкий двусторонний
 DE Winkelprofil GLAX, zum Aufschieben auf Plattenkante, zweiseitig, schmal
 HU GLAX LED Profil kétoldalú, keskeny



PA-GLAXMNBWDW3M-AL	3 m	profil, profile, профиль, Profile, profilok	srebrny, silver, серебристый silber, ezüst	aluminium, aluminium alumínium, Aluminium aluminium	5902801259142
PA-OSMLGLAXM3M-00		oslonka mini, cover mini, крышка мини, Abdeckung mini, Takaró mini	mleczna, soft white, белый матовый, milchig, tejszínű	tworzywo, plastic, пластмасса, Kunststoff, plasztik	5902801024054
PA-OSTRGLAXM3M-00		transparentna, transparent, прозрачная, durchsichtig, átlátszó	5902801024047		

Oslonki / Covers / Крышки / Abdeckungen / Takarók:

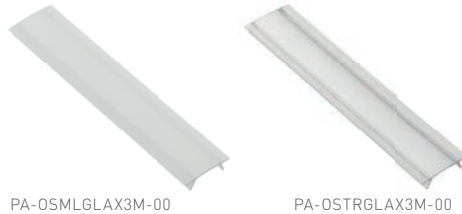

PA-OSMLGLAXM3M-00

PA-OSTRGLAXM3M-00

PL Profil GLAX wpuszczany z poliwęglanu
 EN Recessed polycarbonate profile GLAX
 RU Профиль GLAX врезной из поликарбоната
 DE Einlassprofil GLAX aus Polycarbonat
 HU Polikarbon profil



PW-PC61209-00

PW-PC31209-00N

PW-PC31209-00N	2 m	mleczna, frosted, молочная, milchig, tejszínű	tworzywo, plastic, пластмасса, Kunststoff, plasztik	5901867175922
PW-PC61209-00		transparentna, transparent, прозрачная, durchsichtig, átlátszó	5901867166197	

PL Oprawa nakładana / wpuszczana
 EN Fixture surface mounted / recessed
 RU Светильник накладной / врезной
 DE Auf- bzw. Einbauleuchte
 HU Felültre szerelt / süllyesztett lámpatest



VASCO

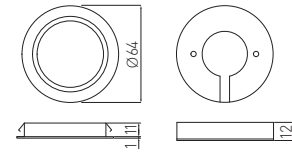

LD-VA24CB-10	130 lm	● 3000 K	biały połysk white gloss белый глянец weiß glänzend Fényes fehér	tworzywo, plastic, пластмасса, Kunststoff, plasztik	5901867172952
LD-VA24NE-10		● 4000 K			5901867173027
LD-VA24ZB-10		● 6000 K			5901867173089
LD-VA24CB-20		● 3000 K	czarny połysk black gloss чёрный глянец schwarz glänzend Fényes fekete		5901867172921
LD-VA24NE-20		● 4000 K			5901867172990
LD-VA24ZB-20		● 6000 K			5901867173058
LD-VA24CB-53		● 3000 K	aluminium, aluminium алюминий, Aluminium aluminium		5908231382627
LD-VA24NE-53		● 4000 K			5908231382641
LD-VA24ZB-53		● 6000 K			5908231382634



PL Oprawa LED
 EN LED fitting
 RU Светильник LED
 DE LED-Leuchte
 HU LED lámpatest

LUMINO

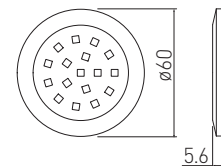

LD-LU16CB-10	70-85 lm	● 2700 K	biały połysk white gloss белый глянец weiß glänzend Fényes fehér	tworzywo, plastic, пластмасса, Kunststoff, plasztik	5901867173133
LD-LU16NE-10		● 4000 K			5901867173171
LD-LU16ZB-10		● 6500 K			5901867173218
LD-LU16CB-20		● 2700 K	czarny połysk black gloss чёрный глянец schwarz glänzend Fényes fekete		5901867173119
LD-LU16NE-20		● 4000 K			5901867173157
LD-LU16ZB-20		● 6500 K			5901867173195
LD-LU16CB-53		● 2700 K	aluminium, aluminium алюминий, Aluminium aluminium		5901867164742
LD-LU16NE-53		● 4000 K			5901867160874
LD-LU16ZB-53		● 6500 K			5901867160850



PL Oprawa LED
EN LED fitting
RU Светильник LED
DE LED-Leuchte
HU LED lámpatest

JOVITA

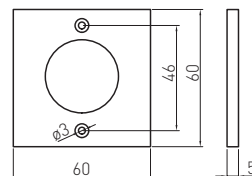

LD-KJVCOB-CB	200 lm	3000 K	aluminium, aluminium алюминий, Aluminium aluminium	aluminium, aluminium алюминий, Aluminium aluminium	5901867101761
LD-KJVCOB-ZB		6400 K			5901867101778



PL Oprawa LED
EN LED fitting
RU Светильник LED
DE LED-Leuchte
HU LED lámpatest

JOVITA

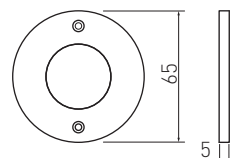

LD-OJVCOB-CB	200 lm	3000 K	aluminium, aluminium алюминий, Aluminium aluminium	aluminium, aluminium алюминий, Aluminium aluminium	5901867101747
LD-OJVCOB-ZB		6400 K			5901867101754



PL Oprawa LED
EN LED fitting
RU Светильник LED
DE LED-Leuchte
HU LED lámpatest

JOVITA

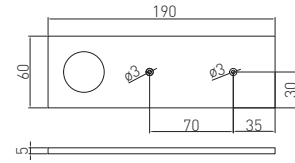

LD-PJVC0B-CB	200 lm	● 3000 K	aluminium, aluminium алюминий, Aluminium aluminium	aluminium, aluminium алюминий, Aluminium aluminium	5901867101860
LD-PJVC0B-ZB		● 6400 K			5901867101877



PL Oprawa LED
EN LED fitting
RU Светильник LED
DE LED-Leuchte
HU LED lámpatest

LUGO

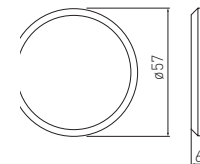

LD-LCG119-53	110 lm	● 3000 K	aluminium, aluminium алюминий, Aluminium aluminium	tworzywo, plastic, пластмасса, Kunststoff, plasztik	5908231322470
LD-LUG119-53		● 6400 K			5908231322548
LD-LCG119-40		● 3000 K	chrom, chrome, хром, Chrom, króm		5908231331977
LD-LUG119-40		● 6400 K			5908231322432
LD-LCG119-52		● 3000 K	satyna satin сатин		5908231322449
LD-LUG119-52		● 6400 K	Nickel matt Szatén		5908231322418



PL Oprawa LED
EN LED fitting
RU Светильник LED
DE LED-Leuchte
HU LED lámpatest

CASTELLO

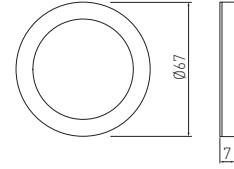

LD-CSN36CB-53	180 lm	● 3000 K	aluminium, aluminium алюминий, Aluminium aluminium	tworzywo, plastic, пластмасса, Kunststoff, plasztik	5908231389244
LD-CSN36ZB-53		● 6500 K			5901867107411



PL Oprawa LED z włącznikiem
EN LED fitting with switch
RU Светильник LED с выключателем
DE LED Aufbauleuchte mit Schalter
HU LED Lámpatest kapcsolóval

CASTELLO

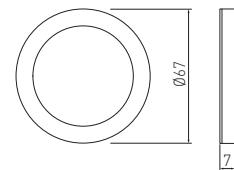

LD-CS36CB-53	180 lm	● 3000 K	aluminium, aluminium алюминий, Aluminium aluminium	tworzywo, plastic, пластмасса, Kunststoff, plasztik	5908231382597
LD-CS36NE-53		● 4000 K			5908231382603
LD-CS36ZB-53		● 6200 K			5908231382610



PL Oprawa LED
EN LED fitting
RU Светильник LED
DE LED-Leuchte
HU LED lámpatest

ESTELLA

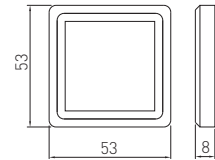

LD-ES21ZB-53N	110 lm	6400 K	aluminium, aluminium алюминий, Aluminium aluminium	tworzywo, plastic, пластмасса, Kunststoff, plasztik	5902801046322



PL Oprawa LED
EN LED fitting
RU Светильник LED
DE LED-Leuchte
HU LED lámpatest

VEGAS

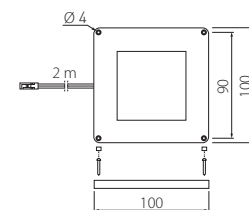

LD-VE15CB-53	140 lm	3000 K	aluminium, aluminium алюминий, Aluminium aluminium	tworzywo, aluminium plastic, aluminium пластмасса, алюминий Kunststoff, Aluminium plasztik, aluminium	5902801032134
LD-VE15NE-53	145 lm	4000 K			5902801032189
LD-VE15ZB-53	150 lm	6400 K			5902801032127



PL Oprawa 2 w 1
EN Fixture 2 in 1
RU Светильник 2 в 1
DE Aufbauleuchte 2-in-1
HU 2 az 1-ben lámpatest

VEGAS

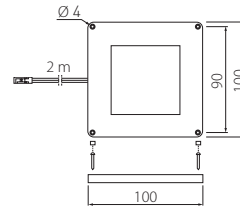

Powiązane produkty:
Włącznik, regulator światła
AE-WLKON-20
Related products:
Switch, colour temperature controller
AE-WLKON-20
Связанных с ними продуктов:
Выключатель, регулятор цветовой
температуры
AE-WLKON-20
Verwandte Produkte:
Schalter, Lichtsteuerung
AE-WLKON-20
Kapcsolódó termékek:
Kapcsoló, fény szabályozó
AE-WLKON-20



LD-VE15CBZB-53	140 lm	● 3000 K - ● 6400 K	aluminium, aluminium алюминий, Aluminium aluminium	tworzywo, aluminium plastic, aluminium пластмасса, алюминий Kunststoff, Aluminium plasztik, aluminium	5902801032219



PL Oprawa LED
EN LED fitting
RU Светильник LED
DE LED-Leuchte
HU LED lámpatest

ISLA

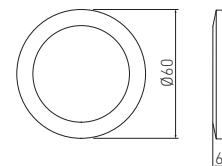

LD-IS09CB-53	56 lm	● 3000 K	aluminium, aluminium, алюминий, Aluminium, aluminium	tworzywo, plastic, пластмасса, Kunststoff, plasztik	5908231394101
LD-IS09NE-53		● 4000 K			5908231394118
LD-IS09ZB-53		● 6400 K			5908231394125



PL Oprawa LED wpuszczana
 EN Flush-mounted LED fitting
 RU Светодиодный светильник врезной
 DE LED-Einbauleuchte
 HU Süllyesztett LED lámpatest

ALVARO

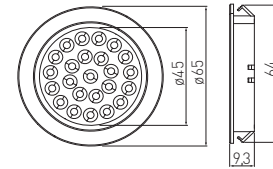

Folder	Light	Color	Material	Material	Barcode
LD-AL24CB-53	130 lm	● 3000 K	aluminium, aluminium, алюминий, Aluminium, aluminium	tworzywo, plastic, пластмасса, Kunststoff, plasztik	5901867156976
LD-AL24NE-53		● 4000 K			5901867156969
LD-AL24ZB-53		● 6400 K			5901867156952



PL Oprawa LED
 EN LED fitting
 RU Светильник LED
 DE LED-Leuchte
 HU LED lámpatest

TREVI

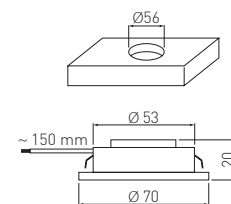

Folder	Light	Color	Material	Material	Barcode
LD-TR24CB-53	300 lm	● 3000 K	aluminium, aluminium, алюминий, Aluminium, aluminium	tworzywo, plastic, пластмасса, Kunststoff, plasztik	5902801032905
LD-TR24ZB-53		● 6400 K			5902801032998



PL Oprawa trójkątna z włącznikiem
 EN Triangular LED fitting with a switch-key
 RU Светодиодный светильник треугольный с выключателем
 DE Dreieckige LED-Leuchte mit Schalter
 HU Háromszög alakú LED lámpatest kapcsolóval

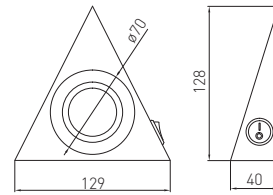

Icon: Folder	Icon: Sun	Icon: Three dots	Icon: Leaf	Icon: Cubes	Icon: Barcode
LD-OPT30S-53N	100 lm	● 3000 K	aluminium, aluminium, алюминий, Aluminium, alumínium	stal, steel, сталь, Stahl, acél	5901867174512
LD-OPT60S-53N		● 6400 K			5901867174192
LD-OPT30S-51N		● 3000 K	stal szczotkowana, brushed steel, шлифованная сталь, Edelhahloptik Csizolt fém		5901867174499
LD-OPT60S-51N		● 6400 K			5901867174239
LD-OPT30S-52N		● 3000 K	satyna satin сатин Nickel matt Szatén		5901867174215
LD-OPT60S-52N		● 6400 K			5901867174413



PL Zestaw opraw trójkątnych z włącznikiem
 EN Triangle fixture kit with switch
 RU Комплект треугольных светильников с выключателем
 DE Dreieckleuchtenet mit Schalter
 HU Háromszögű fényttest szet, kapcsolóval

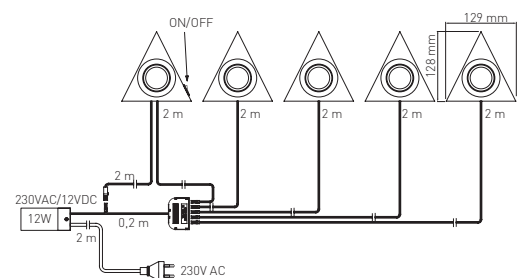

Icon: Folder	Icon: Sun	Icon: Three dots	Icon: Leaf	Icon: Cubes	Icon: Barcode
LD-Z5OTCB-51	5x100 lm	● 3000 K	stal szczotkowana, brushed steel, шлифованная сталь, Edelhahloptik, Csizolt fém	stal, tworzywo, steel, plastic, сталь, пластмасса, Stahl, Kunststoff, acél, plasztik	5908231385352



PL Zestaw opraw z włącznikiem
 EN Fixture kit with switch
 RU Комплект светильников с выключателем
 DE Leuchtensatz mit Schalter
 HU Kapcsolós lámpatest készlet

CASTELLO

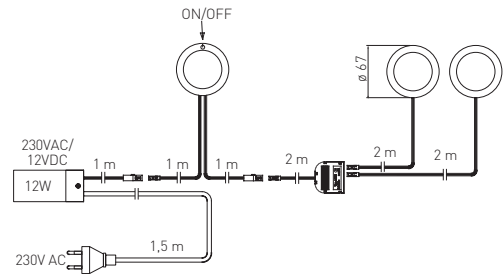

LD-Z3CSCB-53	3x180 lm	3000 K	aluminium, aluminium, алюминий, Aluminium, aluminium	tworzywo, plastic, пластмасса, Kunststoff, plasztik	5908231389251



PL Zestaw opraw z włącznikiem
 EN Fixture kit with switch
 RU Комплект светильников с выключателем
 DE Leuchtensatz mit Schalter
 HU Kapcsolós lámpatest készlet

CASTELLO

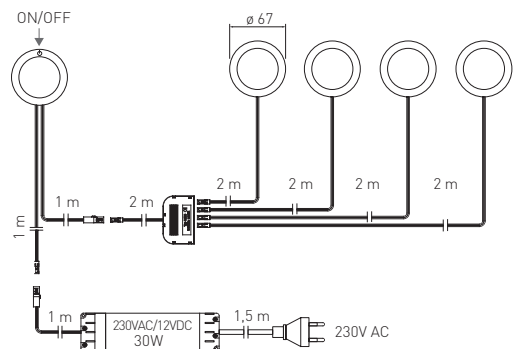

LD-Z5CSCB-53	5x180 lm	3000 K	aluminium, aluminium, алюминий, Aluminium, aluminium	tworzywo, plastic, пластмасса, Kunststoff, plasztik	5908231389268



PL Zestaw opraw
EN Fixture kit
RU Комплект светильников
DE Leuchtenset
HU Lámpatest készlet

LUGO

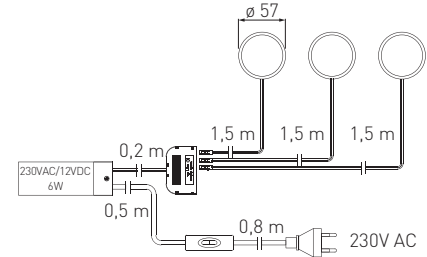

LD-LCG319-53	3x100 lm	● 3000 K	aluminium, aluminium, алюминий, Aluminium, alumínium	tworzywo, plastic, пластмасса, Kunststoff, plasztik	10	5908231301024
LD-LUG319-53		● 6400 K			20	5908231301017
LD-LCG319-40		● 3000 K	chrom, chrome, хром, Chrom, króm		16	5908231301031
LD-LUG319-40		● 6400 K			20	5908231300997
LD-LCG319-52		● 3000 K	satyna, satin, сатин, Nickel matt, Szatén		20	5908231301048
LD-LUG319-52		● 6400 K			20	5908231301000



PL Zestaw opraw
EN Fixture kit
RU Комплект светильников
DE Leuchtenset
HU Lámpatest készlet

BARRI

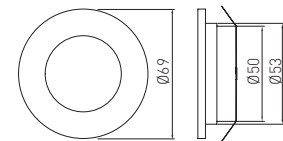

LD-OBP27CB-53	3x80 lm	● 2700 K	aluminium, aluminium, алюминий, Aluminium, alumínium	tworzywo, aluminium plastic, aluminium пластмасса, алюминий Kunststoff, Aluminium plasztik, alumínium	5908231374127
LD-OBP27ZB-53		● 6400 K			5908231374134



PL Zestaw opraw
EN Fixture kit
RU Комплект светильников
DE Leuchtenset
HU Lámpatest készlet

MARBELLA

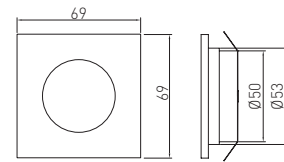

Folder	Light	Color	Material	Material	Barcode
LD-KWP27CB-53	3x80 lm	● 2700 K	aluminium, aluminium, алюминий, Aluminium, aluminium	tworzywo, aluminium plastic, aluminium пластмасса, алюминий Kunststoff, Aluminium plasztik, aluminium	5908231374103
LD-KWP27ZB-53		● 6400 K			5908231374110



PL Listwa LED z zasilaczem
EN LED strip with power supply
RU Светодиодная планка с трансформатором
DE LED-Leiste mit Netzgerät
HU LED szalag tápegységgel

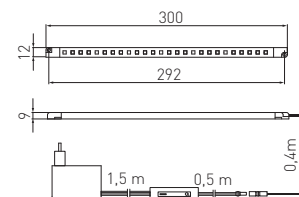

Folder	Light	Color	Material	Material	Barcode
LD-LL27CB-00	140 lm	● 3000 K	chrom, chrome, хром, Chrom, króm	tworzywo, plastic, пластмасса, Kunststoff, plasztik	5908231301062
LD-LL27ZB-00		● 6400 K			5908231301079



PL Oprawa wpuszczana
EN Recessed fixture
RU Врезной светильник
DE Einbauleuchte
HU Süllyesztett lámpatest

OVIEDO

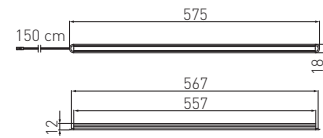

LD-WL2457-53	90 lm	6400 K	aluminium, aluminium, алюминий, Aluminium, aluminium	tworzywo, aluminium plastic, aluminium пластмасса, алюминий Kunststoff, Aluminium plasztik, aluminium	5908231301864



PL Oprawa podszafkowa z włącznikiem
EN Cabinet fixture with switch
RU Светильник под шкафчики с выключателем
DE LED-Unterschrankleuchte mit Schalter
HU Szekrény alatti LED lámpatest kapcsolóval

FRAGA

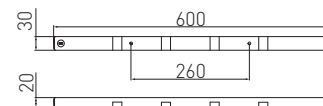
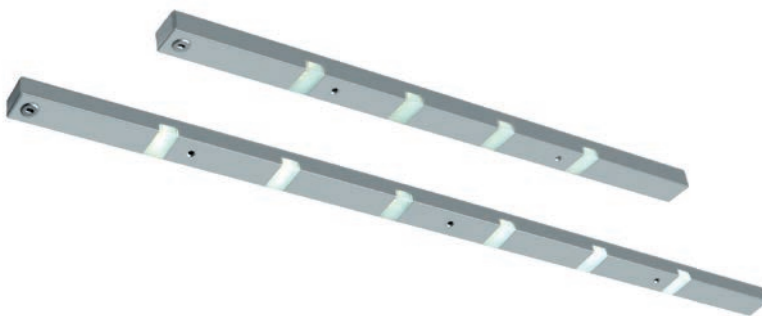

LD-OP408C-53	3 W	90 lm	6400 K	aluminium, aluminium, алюминий, Aluminium, aluminium	tworzywo, aluminium plastic, aluminium пластмасса, алюминий Kunststoff, Aluminium plasztik, aluminium	5908231301833
LD-OP608C-53	4,1 W	135 lm				5908231301840



PL Oprawa podszafkowa
EN Cabinet fixture
RU Светильник под шкафчики
DE LED-Unterschrankleuchte
HU Szekrény alatti LED lámpatest

ROTA

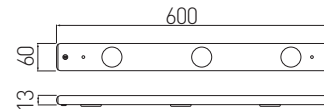

Folder	W	Light	Color	Material	Material	Barcode
LD-OP456C-53	4,2 W	230 lm	● 6400 K	aluminium, aluminium, алюминий, Aluminium, aluminium	tworzywo, aluminium plastic, aluminium пластмасса, алюминий Kunststoff, Aluminium plasztk, aluminium	5908231301802
LD-OP609C-53	5,5 W	310 lm				5908231301819



PL Oprawa podszafkowa
EN Cabinet fixture
RU Светильник под шкафчики
DE LED-Unterschrankleuchte
HU Szekrény alatti LED lámpatest

OPD



Folder	W	Light	Color	LxWxH mm	Material	Material	Barcode
LD-OPD5W0-CB	5 W	300 lm	● 3000 K	325 x 30 x 22	chrom, chrome, хром, Chrom, króm	metal metal металл Metall Fém	5901867158376
LD-OPD9W0-CB	9 W	350 lm		585 x 30 x 22			5901867158383



PL Oprawa z czujnikiem zbliżeniowym
EN Fixture with proximity sensor
RU Светильник с датчиком приближения
DE LED-Leuchte mit Annäherungssensor
HU LED lámpatest mozgásérzékelővel

SORIA

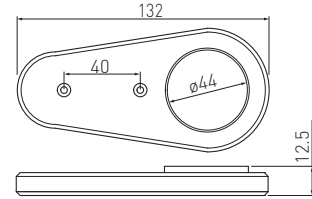

Folder	Light	Color	Material	Material	Barcode
LD-SR16CB-53	90-110 lm	3000 K	aluminium, aluminium, алюминий, Aluminium, aluminium	aluminium, aluminium, алюминий, Aluminium, aluminium	5908231387110
LD-SR16NE-53		4000 K			5908231387127
LD-SR16ZB-53		6400 K			5908231387134



PL Oprawa na wysięgniku
EN Fixture with arm
RU Светильник типа „дуга”
DE LED-Leuchte mit Arm
HU Karos LED lámpatest

FOCUS

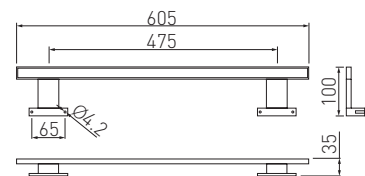

Folder	Light	Color	Material	Material	Barcode
LD-FO120CB-40	740 lm	3000 K	chrom, chrome, хром, Chrom, króm	tworzywo, aluminium plastic, aluminium пластмасса, алюминий Kunststoff, Aluminium plasztik, aluminium	5902801024702
LD-FO120ZB-40		6400 K			5902801024719



PL Oprawa na wycięgniku
EN Fixture with arm
RU Светильник типа „дуга”
DE LED-Leuchte mit Arm
HU Karos LED lámpatest

RADIUS II

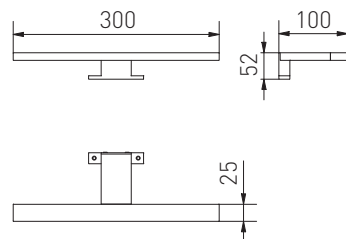

LD-RA60CB-40N	220 lm	● 3000 K	chrom, chrome, хром, Chrom, króm	tworzywo, plastic, пластмасса, Kunststoff, plasztik	5902801231070
LD-RA60ZB-40N		● 6000 K			125 g



PL Oprawa na wycięgniku
EN Fixture with arm
RU Светильник типа „дуга”
DE LED-Leuchte mit Arm
HU Karos LED lámpatest

MAXIMUS

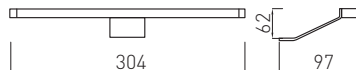

LD-MAX60CB-40N	160 lm	● 3000 K	chrom, chrome, хром, Chrom, króm	tworzywo, aluminium plastic, aluminium пластмасса, алюминий Kunststoff, Aluminium plasztik, aluminium	5902801033575
LD-MAX60ZB-40N		● 6400 K			



PL Oprawa na wycięgniku
EN Fixture with arm
RU Светильник типа „дуга”
DE LED-Leuchte mit Arm
HU Karos LED lámpatest

COSTA

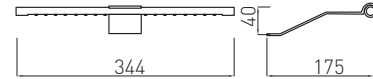

LD-CO20CB-53	100 lm	● 3000 K	aluminium, aluminium, алюминий, Aluminium, aluminium	tworzywo, aluminium plastic, aluminium пластмасса, алюминий Kunststoff, Aluminium plasztik, aluminium	5901867180537
LD-CO20ZB-53		● 6400 K			5901867180520



PL Oprawa na wycięgniku
EN Fixture with arm
RU Светильник типа „дуга”
DE LED-Leuchte mit Arm
HU Karos LED lámpatest

ABELLA

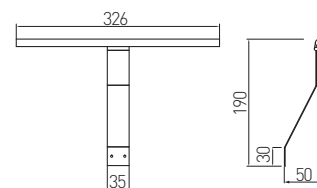

LD-AB18CB-53	460 lm	● 3000 K	aluminium, aluminium, алюминий, Aluminium, aluminium	stal, aluminium, tworzywo steel, aluminium, plastic сталь, алюминий, пластмасса Stahl, Aluminium, Kunststoff acél, aluminium, plasztik	5908231396310
LD-AB18ZB-53		● 6400 K			5908231396303



PL Oprawa na wycięgniku
EN Fixture with arm
RU Светильник типа „дуга”
DE LED-Leuchte mit Arm
HU Karos LED lámpatest

EVITA

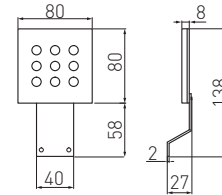

LD-EIW09CB-CZ	120 lm	3000 K	czarny, black, черный, schwarz, fekete	tworzywo, aluminium plastic, aluminium пластмасса, алюминий Kunststoff, Aluminium plasztik, aluminium
5901867101402				



PL Oprawa na wycięgniku
EN Fixture with arm
RU Светильник типа „дуга”
DE LED-Leuchte mit Arm
HU Karos LED lámpatest

NOELIA

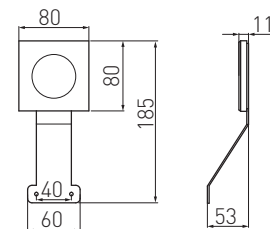

LD-NO24CB-00	330 lm	3000 K	aluminium, aluminium, алюминий, Aluminium, aluminium	tworzywo, aluminium plastic, aluminium пластмасса, алюминий Kunststoff, Aluminium plasztik, aluminium
LD-NO24ZB-00		6400 K		
5908231398260				



PL Oprawa na wycięgniku
EN Fixture with arm
RU Светильник типа „дуга”
DE LED-Leuchte mit Arm
HU Karos LED lámpatest

FIDELIA

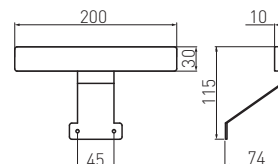

LD-FL36CB-00	155 lm	3000 K	aluminium, aluminium, алюминий, Aluminium, aluminium	tworzywo, aluminium plastic, aluminium	5902801003264
LD-FL36ZB-00	165 lm	6400 K	Aluminium, aluminium	пластмасса, алюминий Kunststoff, Aluminium plasztik, aluminium	5908231398291



PL Oprawa na wycięgniku
EN Fixture with arm
RU Светильник типа „дуга”
DE LED-Leuchte mit Arm
HU Karos LED lámpatest

CALDERON

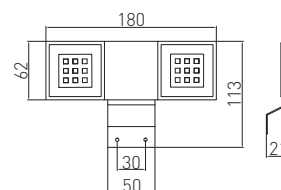

LD-NKW18CB-40	270 lm	3000 K	chrom, chrome, хром, Chrom, króm	stal, tworzywo steel, plastic	5908231386557
LD-NKW18ZB-40		6400 K	Stahl, Kunststoff acél, plasztik	5908231364838	



PL Oprawa LED bezprzewodowa
 EN Cordless LED fitting
 RU Светодиодный светильник беспроводной
 DE Kabellose LED-Leuchte
 HU Vezeték nélküli LED lámpatest

COMA



LD-IRUSB-53

LD-PIRUSB-53

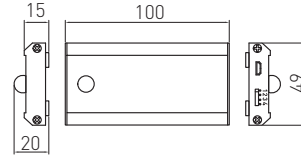

Przewód USB (do ładowania) - 0,5 m w komplecie
 Additional 0,5m USB cable (for charging)
 Дополнительный кабель USB (для зарядки) - 0,5 м
 USB-Kabel (zum Laden) 0,5 m ist im Lieferumfang enthalten.
 Tartalmaz USB kábelt (töltésre) - 0,5m

				INFO			
LD-IRUSB-53				Czujnik zbliżeniowy IR, jedno- lub dwu-biegowy, Proximity sensor IR, single or double-pole, Датчик движения IR, одно- и многофункциональный, Näherungsschalter IR (2 Funktionen: Bewegungsschalter und Schranktür-Schalter) közelségérzékelő IR, egy vagy két pólusu	aluminium, aluminium, алюминий, Aluminium, aluminium	stal, tworzywo steel, plastic сталь, пластмасса Stahl, Kunststoff acél, plasztik	5901867188182
LD-PIRUSB-53				Czujnik ruchu PIR, jednobiegowy, Proximity sensor IR, single-pole, Датчик движения PIR, однофункциональный, Bewegungs- und Präsenzsensoren PIR Schranktür-Schalter, Mozgás és jelenlétérzékelő PIR két pólusu			5901867188199



PL Lampka z portem USB
 EN Bed lamp with USB
 RU Гибкая лампа с USB-разъемом
 DE Leseleuchte mit USB-Anschluss
 HU USB-s lámpa

CHICAGO

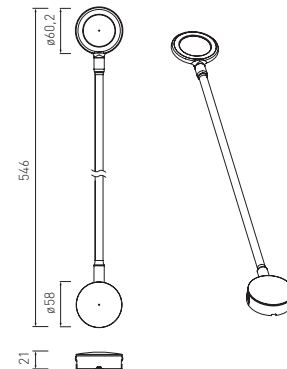

LD-CHIC16NE-10				metal, tworzywo metal, plastic металл, пластмасса Metall, Kunststoff fém, plasztik	biały, white, белый, weiß, fehér	5901867177919
LD-CHIC16NE-20					czarny, black, черный, schwarz, fekete	5901867177933



PL Lampka
EN Lamp
RU Лампа
DE Lämpchen
HU Lámpa

BOSTON

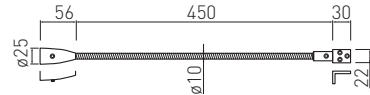

Wymaga zasilacza 12 V, 6 W
Requires 12 V, 6 W power supply
Требуется блок питания 12 В, 6 Вт
Netzteil 12 V, 30 W erforderlich
Igényel 12V, 6W trafót

LD-BOS1CBWG-53	90 lm	● 3000 K	aluminium, aluminium, алюминий, Aluminium, aluminium	stal, aluminium, tworzywo steel, aluminium, plastic сталь, алюминий, пластмасса Stahl, Aluminium, Kunststoff acél, aluminium, plasztik	5902801002915
LD-BOS1CBWB-53					5902801002939



PL Klip plastikowy LED do półek
EN Plastic LED clip for shelves
RU Пластиковая клипса LED для стеклянных полок
DE LED-Clip aus Kunststoff
HU Műanyag LED polcvilágítás

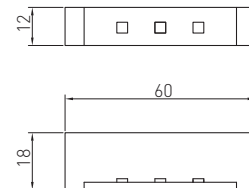

LD-KLPCB-00N	10 lm	● 3000 K	tworzywo plastic пластмасса Kunststoff plasztik	5901867188205
LD-KLPNB-00N	-	niebieski, blue, синий, blau, kék		5901867173997
LD-KLPZB-00N	12 lm	● 6400 K		5901867187734



PL Klip metalowy LED do półek
EN Metal LED clip for shelves
RU Металлическая клипса LED для стеклянных полок
DE LED-Clip aus Metall
HU Fém LED polcvilágítás

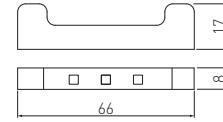
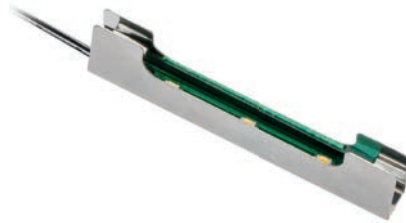

LD-3SKL-CBN	10 lm	● 3000 K	stal, steel, сталь, Stahl, acél,	5901867183538
LD-3SKL-NBN	-	niebieski, blue, синий, blau, kék		5901867183514
LD-3SKL-ZBN	12 lm	● 6400 K		5901867175212



PL Oprawa LED punktowa, wpuszczana
EN Flush-mounted, point LED fitting
RU Светодиодный светильник точечный, врезной
DE LED-Punktleuchte zum Einlassen
HU Süllyesztett LED spot lámpatest

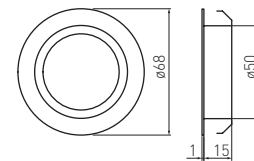

OM-OPW000-60	max 20 W	złoto, gold, золото, gold, arany	stal, steel, сталь, Stahl, acél,	5908231300973
OM-OPW000-61		stare złoto, antique gold, старое золото, Altgold, Régi arany		5908231300980



PL Zestaw opraw halogenowych
 EN Halide lamp fixture set
 RU Комплект галогенных светильников
 DE Halogenleuchtensatz
 HU Halogén lámpatest készlet

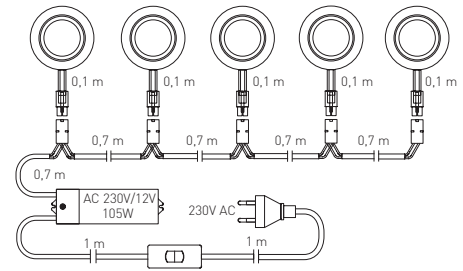

OM-ZH5200-53	max 5 x 20 W	aluminium, aluminium, алюминий, Aluminium, aluminium	stal, tworzywo steel, plastic сталь, пластмасса Stahl, Kunststoff acél, plasztik	5908231300645
OM-ZH5200-60		złoto, gold, золото, gold, arany		5908231300652



PL Zasilacze LED
 EN LED power supply units
 RU Блоки питания LED
 DE LED-Netzteile
 HU LED tápegységek

**OUTPUT
12 V DC**

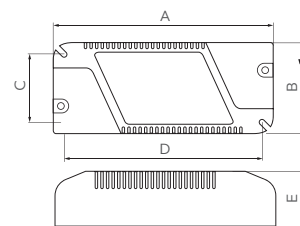

LD-ZAS06W-30N	max 6 W	A=107, B=39, C=29, D=95, E=25	tworzywo, plastic, пластмасса, Kunststoff, plasztik	50 g	5901867154279
LD-ZAS12W-30N	max 12 W	A=122, B=45, C=33, D=107, E=25		70 g	5901867154293
LD-ZAS15W-30N	max 15 W	A=122, B=45, C=34, D=107, E=25		70 g	5901867154316
LD-ZAS30W-30N	max 30 W	A=169, B=48, C=37, D=154, E=31		140 g	5901867157171
LD-ZAS50W-30N	max 50 W	A=169, B=48, C=37, D=154, E=31		150 g	5901867157188
LD-ZAS75W-30	max 75 W	A=180, B=52, C=42, D=176, E=30		350 g	5901867141477



PL Zasilacz LED puszkowy
EN LED power supply
RU Светодиодный трансформатор LED
DE LED-Netzgerät für Montagedosen
HU Doboos LED tápegység

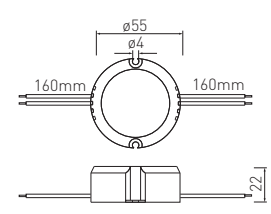

LD-ZASPU15W-30N	15 W	tworzywo, plastic, пластмасса, Kunststoff, plasztk	5902801020094

PL Układ zasilający do klipów LED 5-punktowy
EN Power supply set for 5 LED clips
RU Блок питания для светодиодных клипс, 5 разъёмов
DE Stromversorgungssystem für 5-Punkt-LED-Clips
HU 5 pontos tápellátás LED polcvilágításhoz

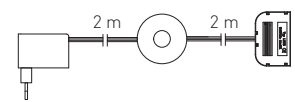

LD-ZSKL15-00	tworzywo, plastic, пластмасса, Kunststoff, plasztk	5901867120601

PL Układ zasilający
EN Power supply set
RU Блок питания
DE Stromversorgungssystem
HU Tápellátó rendszer

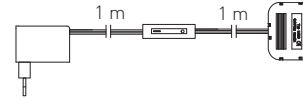

LD-ZWND6W-10	max 6 W	tworzywo, plastic, пластмасса, Kunststoff, plasztik	5908231335753
LD-ZWND12-10	max 12 W		5908231336675



PL Układ zasilający z przewodami bez włącznika i dystrybutorem 6x mini amp
EN Power supply without switch, with 6x mini AMP distributor
RU Блок питания с проводами и дистрибьютором 6x мини амр, без выключателя
DE Stromversorgungssystem mit Kabeln ohne Schalter und mit einem 6-fach Miniverteiler
HU Tápellátó rendszer kábellel, kapcsoló nélkül és 6x mini amp elosztóval

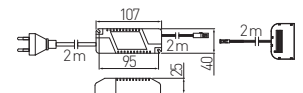
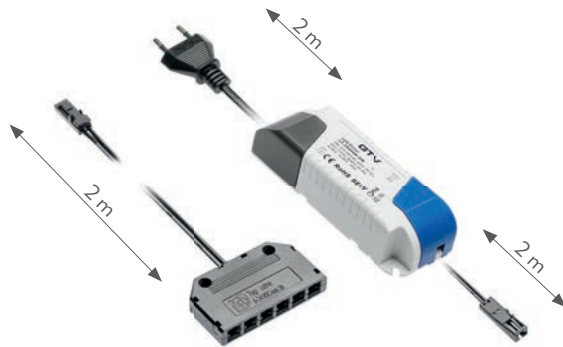

LD-ZZAS06KD6

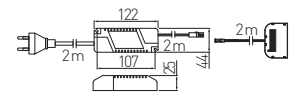

LD-ZZAS12KD6, LD-ZZAS15KD6

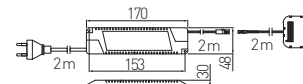

LD-ZZAS30KD6

LD-ZZAS06KD6	6 W	tworzywo, plastic, пластмасса, Kunststoff, plasztik	5901867189738
LD-ZZAS12KD6	12 W		5901867189745
LD-ZZAS15KD6	15 W		5901867189783
LD-ZZAS30KD6	30 W		5901867189776



PL Zasilacze LED
EN LED power supply units
RU Блоки питания LED
DE LED-Netzteile
HU LED tápegységek

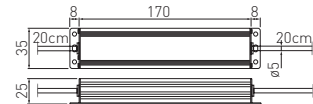

LD-WZA20W-NW

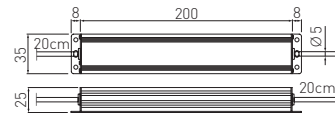

LD-WZA36W-NW

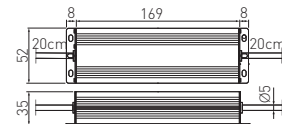

LD-WZA60W-NW

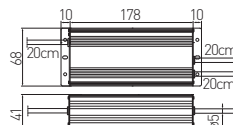

LD-WZA80W-NW

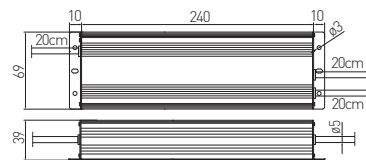

LD-WZA150W-NW

Folder Icon	Wattage Icon	Weight Icon	Barcode Icon
LD-WZA20W-NW	20 W	170 g	5901867128720
LD-WZA36W-NW	36 W	310 g	5901867128744
LD-WZA60W-NW	60 W	990 g	5901867128768
LD-WZA80W-NW	80 W	1000 g	5901867128782
LD-WZA150W-NW	150 W	2000 g	5901867128805



PL Ściemniacz LED
EN LED dimmer
RU Светодилдный диммер
DE LED-Dimmer
HU LED sötétítő

JACKY, JACKY 2

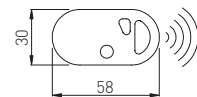
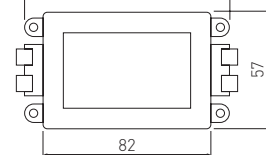
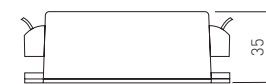

Folder Icon	Barcode Icon	Weight Icon	Material Icon	Color Icon	Power Icon	Barcode Icon
LD-DIMLED-10	kodowany, coded, Закодированный, codiert, codiert	800 g	PC	czarny, black, черный, schwarz, fekete	MAX 8 A	5908231337597
LD-DIMLED2-10	niekodowany, uncoded, некодированная, uncodiert, kódolatlan					5902801005916



PL Transformator elektroniczny do żarówek halogenowych
 EN Electronic power supply for halogen lamp
 RU Электронный трансформатор для галогенной лампы
 DE Elektronischer Transformator für Halogenlampen
 HU Elektronikus transzformátor halogén lámpához

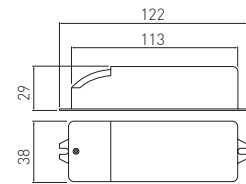

TE-600000-30

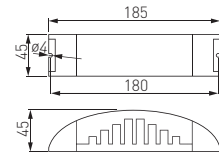

TE-150000-30
TE-200000-30

TE-600000-30	max 60 W	tworzywo, plastic, пластмасса, Kunststoff, plasztik	5908231300928
TE-150000-30	max 150 W		5908231300898
TE-200000-30	max 200 W		5908231300904



PL Kontroler RGB mini z pilotem
 EN Mini RGB controller with remote
 RU Миниконтроллер RGB с пультом
 DE Steuergerät LED-RGB mini mit Fernbedienung
 HU LED RGB mini vezérlő távirányítóval

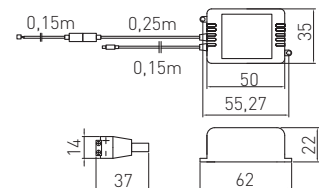

LD-KONMINI-RGB	RGB	tworzywo, plastic, пластмасса, Kunststoff, plasztik	5908231384676



PL Kontroler RGB z pilotem
 EN RGB controller with remote
 RU RGB контроллер с пультом
 DE Steuergerät LED-RGB mit Fernbedienung
 HU LED RGB vezérlő távirányítóval

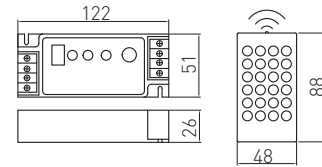

LD-KONRGB-00	RGB	tworzywo, plastic, пластмасса, Kunststoff, plastik	5908231301390
--------------	-----	--	---------------



PL Zestaw RGB - kontroler, zasilacz LED 6W, pilot i dystrybutor
 EN RGB kit - RGB controller, power supply, remote and distributor
 RU Комплект RGB – контролер, трансформатор 6W, пульт, дистрибьютор
 DE RGB-Set, Steuergerät, 6W LED-Netzteil, Fernbedienung und Verteiler
 HU RGB készlet, vezérlő, 6W LED tápegység, távirányító és elosztó

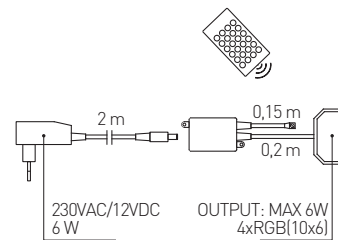

LD-ZAC6WDE-RGB	RGB	tworzywo, plastic, пластмасса, Kunststoff, plastik	5908231399663
----------------	-----	--	---------------



PL Zestaw RGB, taśma LED 5 m, kontroler, zasilacz, pilot
 EN RGB-set, LED band 5 m, RGB controller, LED-transformator, pilot
 RU Комплект RGB, лента LED 5 м, контролер, трансформатор, пульт
 DE RGB-Set, LED-Band 5m, Steuergerät, Netzteil, Fernbedienung
 HU RGB készlet, 5 m-es LED-szalag, vezérlő, tápegység, távirányító

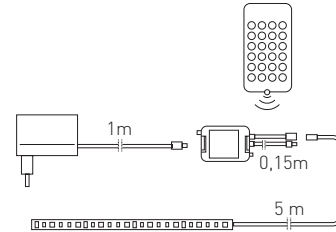

LD-ZL5RGB150-00	RGB	tworzywo, plastic, пластмасса, Kunststoff, plasztik	5902801025839
-----------------	-----	---	---------------



PL Ładowarka indukcyjna z zasilaczem
 EN Wireless charger with power supply
 RU Беспроводное зарядное устройство с блоком питания
 DE Induktionsladegerät mit Netzgerät
 HU Indukciós töltő tápegységgel

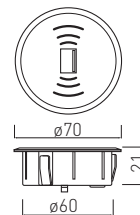

AE-ZUSB-20	czarny, black, черный, schwarz, fekete	tworzywo, plastic, пластмасса, Kunststoff, plasztik	5901867181954
------------	--	---	---------------



PL Ładowarka bezprzewodowa / indukcyjna, podblatowa z zasilaczem
 EN Wireless surface charger
 RU Беспроводное зарядное устройство, под столешницу
 DE Induktionsladegerät mit Netzteil für Mobiltelefone, Untertischmontage
 HU Indukciós töltő, pult alatti tápegység

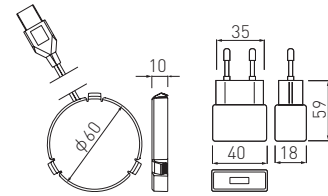

AE-ZLADPOD-20

czarny, black, черный, schwarz, fekete

tworzywo, plastic, пластмасса, Kunststoff, plasztik

5902801031854



PL Włącznik bezdotykowy
EN Touchless switch
RU Бесконтактный датчик
DE Berührungsloser Schalter
HU Érintésmentes kapcsoló

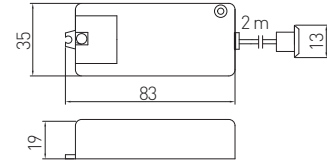

INFO



AE-WBEZDC-10S	dwubiegowy two-pole двухфункциональный Bewegungsschalter egy pólusu	tworzywo, plastic, пластмасса, Kunststoff, plasztik	5901867160348
AE-WBEZDB-10S*	jednobiegowy single-pole однофункциональный Schranktür-Schalter két pólusu		5901867160324



PL Włącznik dotykowy pod śrubę
EN Touch switch under screw
RU Сенсорный выключатель под винт
DE Berührungsschalter, zum Anschließen an Metallgegenstände
HU Csavar alá szerelhető érintőkapcsoló

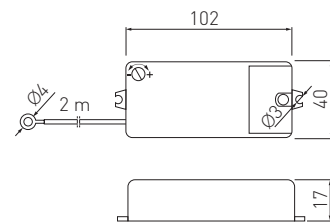

AE-WBEZDK15-10	tworzywo, plastic, пластмасса, Kunststoff, plasztik	5902801032110
----------------	---	---------------



PL Włącznik z czujnikiem ruchu PIR
 EN Switch with PIR motion detector
 RU Выключатель с датчиком движения PIR
 DE Schalter mit Bewegungsmelder PIR
 HU PIR kapcsoló mozgásérzékelővel

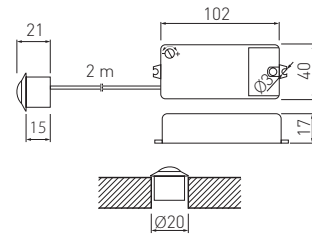

AE-WBEZDPIR-10

tworzywo, plastic, пластмасса, Kunststoff, plasztik

5902801032141



PL Włącznik z dwoma sensorami ruchu PIR II
 EN Switch with two PIR II motion sensors
 RU Выключатель с двумя датчиками движения PIR II
 DE Schalter mit zwei Bewegungsmeldern PIR II
 HU PIR II kapcsoló dupla mozgásérzékelővel

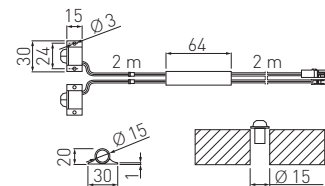

AE-WBEZDPIR2-20

tworzywo, plastic, пластмасса, Kunststoff, plasztik

5902801032639



PL Włącznik bezdotykowy uniwersalny 3 w 1
 EN 3 in 1 all-purpose touchless switch
 RU Бесконтактный выключатель 3 в 1
 DE 3-in-1 universeller berührungsloser Schalter
 HU Univerzális érintésmentes 3 az 1-ben kapcsoló



AE-ADCUNI-10

AE-ADBUNI-10

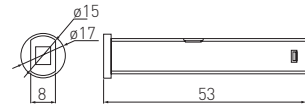

AE-WBBUNI-10DIM	biały, white, белый, weiß, fehér	tworzywo, plastic, пластмасса, Kunststoff, plasztik	5901867158338
AE-WBCUNI-10DIM	czarny, black, черный, schwarz, fekete		5901867158352



PL Włącznik dotykowy ściemniający
 EN Dimmable touch switch
 RU Выключатель с регулятором яркости
 DE Dimmer mit Berührungsschalter
 HU Sötétíthető érintőkapcsoló

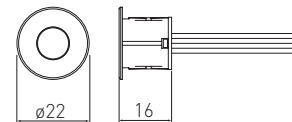

AE-WDSB-10DIM	biały, white, белый, weiß, fehér	tworzywo, plastic, пластмасса, Kunststoff, plasztik	5901867175724
AE-WDSC-10DIM	czarny, black, черный, schwarz, fekete		5901867175748



PL Włącznik dotykowy ściemniający
EN Dimmable touch switch
RU Выключатель с регулятором яркости
DE Dimmer mit Berührungsschalter
HU Sötétíthető érintőkapcsoló

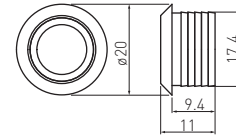

AE-WBEZD-NB

chrom, chrome, хром, Chrom, króm

tworzywo, plastic, пластмасса, Kunststoff, plasztik

5901867143686



PL Włącznik podblatowy
EN Countertop switch
RU Выключатель под столешницу
DE Unterblattschalter
HU Pult alatti kapcsoló

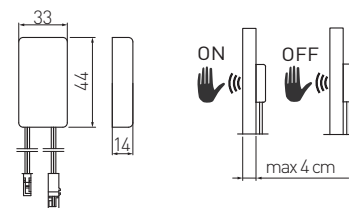

Grubość blatu max 40 mm
Countertop thickness max 40 mm
Толщина столешницы макс. 40 мм
Plattenstärke max. 40 mm
Pult vastagsága max 40mm



AE-WPDRW-00

tworzywo, plastic, пластмасса, Kunststoff, plasztik

5901867127167



PL Włącznik do taśm LED montowany w profil
 EN Switch for LED strips mounted in profile
 RU Выключатель для ленты LED
 DE Schalter für LED-Streifen, montiert im Profil
 HU Profilba szerelt LED szalag kapcsoló

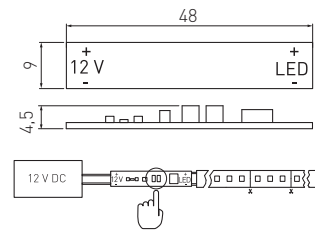

AE-WLPR-60	-	biały, white, белый, weiß, fehér	płytko elektroniczna circuit board электронная плата Elektronikplatine Áramköri lap	5908231398284
AE-WLPR-60P2	2 m			5902801022005



PL Włącznik kotyskowy
 EN Switch
 RU Выключатель кнопочный
 DE Wippschalter
 HU Billenőkapcsoló

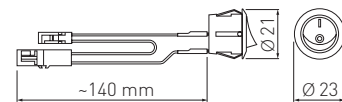

AE-WLB01-10	biały, white, белый, weiß, fehér	tworzywo, plastic, пластмасса, Kunststoff, plasztik	5902801004346
AE-WLC01-20	czarny, black, черный, schwarz, fekete		5902801004322



PL Włącznik łańcuszkowy
EN Pull chain switch
RU Цепной выключатель
DE Kettenzugschalter
HU Lanckapcsoló



AE-WLLAN1-10	polipropylen, polypropylene, полипропилен, Polypropylen, polypropylén	chrom, chrome, хром, chróm, króm	2000	5908231313942
AE-WLLAN1-20		czarny, black, черный, schwarz, fekete		5901867124531
AE-WLLAN1-90		złoty, golden, золотой, Gold, arany		5901867124548



PL Włącznik sznurkowy
EN Pull cable switch
RU Шнурочный выключатель
DE Zugschalter mit Schnur
HU Zsinóros kapcsoló



AE-WLSZN1-10	polipropylen, polypropylene, полипропилен, Polypropylen, polypropylén	czarny, black, черный, schwarz, fekete	590823133186
--------------	---	--	--------------



PL Przełącznik kołkowy okrągły
EN Round rocker switch
RU Выключатель клавишный круглый
DE Wippschalter rund
HU Kerek billenőkapcsoló



AE-WLIP44-15	tworzywo, plastic, пластмасса, Kunststoff, plasztik	biały, white, белый, weiß, fehér	5901867125071
--------------	---	----------------------------------	---------------





PL Włącznik, regulator światła
 EN Switch, colour temperature controller
 RU Выключатель, регулятор цветовой температуры
 DE Schalter mit Farbtemperaturregler
 HU Kapcsoló, fény szabályozó

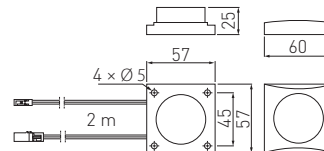

AE-WLKON-20	czarny, black, черный, schwarz, fekete	tworzywo, plastic, пластмасса, Kunststoff, plasztik	5902801032707
-------------	--	---	---------------



PL Przewód ze złączkami mini AMP
 EN Cable with Mini AMP
 RU Кабель с соединителями мини-AMP
 DE Kabel mit mini AMP-Verbindern
 HU Kábel mini AMP csatlakozókkal

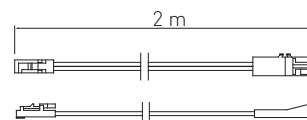

LZ-KAPR2M-10	czarny, black, черный, schwarz, fekete	tworzywo, plastic, пластмасса, Kunststoff, plasztik	5908231335876
--------------	--	---	---------------



PL Złączka do oświetlenia ledowego z dystrybutorem, 3 gniazda
 EN LED lamp connector with distributor, 3 sockets
 RU Соединитель LED с распределителем, 3 гнезда
 DE Verteiler für LED-Beleuchtung, 3-fach
 HU Elosztóval ellátott csatlakozó LED világításhoz, 3 aljzat

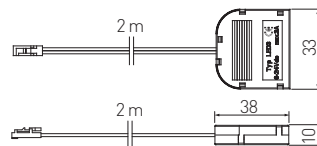

LZ-AKZ312-10N	czarny, black, черный, schwarz, fekete	tworzywo, plastic, пластмасса, Kunststoff, plasztik	5901867174017
---------------	--	---	---------------



PL Złączka do oświetlenia ledowego z dystrybutorem, 6 gniazd
 EN LED lamp connector with distributor, 6 sockets
 RU Соединитель LED с распределителем, 6 гнезд
 DE Verteiler für LED-Beleuchtung, 6-fach
 HU Elosztóval ellátott csatlakozó LED világításhoz, 6 aljzat

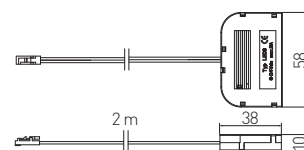

LZ-AKZ612-10N	czarny, black, черный, schwarz, fekete	tworzywo, plastic, пластмасса, Kunststoff, plasztik	5901867187598
---------------	--	---	---------------



PL Złączka XC11 do taśm LED
 EN Connector XC11 for LED strips
 RU Соединитель XC11 для лент LED
 DE Verbinder XC11 für LED-Streifen
 HU XC11 csatlakozó LED szalaghoz



LD-ZTL8MM-02N



LD-ZTL8MM-02N600

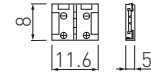

LD-ZTL8MM-02N, LD-ZTL8MM-02N600



LD-ZTL10MM-02N



LD-ZTLRGB-04N

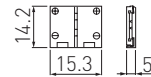

LD-ZTL10MM-02N, LD-ZTLRGB-04N



INFO



LD-ZTL8MM-02N	8 mm	tworzywo, plastic, пластмасса, Kunststoff, plasztik	5901867172556
LD-ZTL8MM-02N600	8 mm / 600 LED		5902801001536
LD-ZTL10MM-02N	10 mm		5901867172587
LD-ZTLRGB-04N	RGB		5901867172617



PL Złączka XC11 do taśm LED kątowa
 EN Angular connector XC11 for LED strips
 RU Угловой соединитель XC11 для лент LED
 DE Eckverbinder XC11 für LED-Streifen
 HU XC11 csatlakozó LED szalaghoz, sarok



LD-ZTK8MM-02N



LD-ZTK8MM-02N600

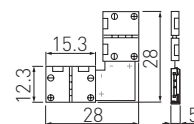

LD-ZTK8MM-02N, LD-ZTK8MM-02N600



LD-ZTK10MM-02N



LD-ZTKRGB-02N

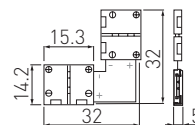

LD-ZTK10MM-02N



LD-ZTKRGB-04N



INFO



LD-ZTK8MM-02N	8 mm	tworzywo, plastic, пластмасса, Kunststoff, plasztik	5901867172853
LD-ZTK8MM-02N600	8 mm / 600 LED		5902801001550
LD-ZTK10MM-02N	10 mm		5901867172884
LD-ZTKRGB-04N	RGB		5901867172822



PL Złączka XC11 do taśm LED z przewodem 15 cm
 EN Connector XC11 with 15 cm cord, for strips
 RU Соединитель XC11 для лент LED, с проводом 15 см
 DE Verbinder XC11 für LED-Streifen 8 mm mit Kabel 15 cm
 HU XC11 csatlakozó LED szalaghoz 15 cm vezetékkel

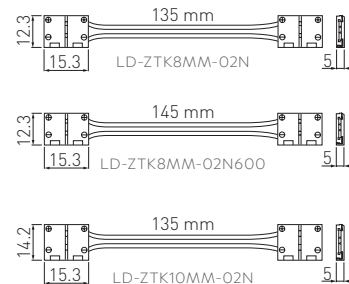

	INFO		
LD-ZTK8MM-02N	8 mm	tworzywo, plastic, пластмасса, Kunststoff, plasztik	5901867172730
LD-ZTK8MM-02N600	8 mm / 600 LED		5902801001543
LD-ZTK10MM-02N	10 mm		5901867172761



PL Złączka XC11 do taśm LED z przewodem 2 m
 EN Connector XC11 with 2 m cord, for LED strips
 RU Соединитель XC11 для лент LED, с проводом 2 м
 DE Verbinder XC11 für LED-Streifen 8 mm mit Kabel 2 m
 HU XC11 csatlakozó LED szalaghoz 2 méteres vezetékkel

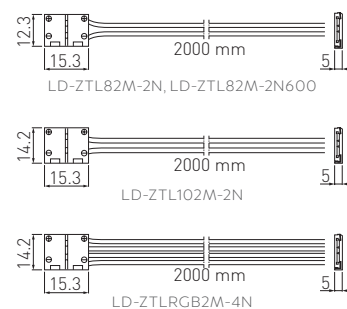

	INFO		
LD-ZTL82M-2N	8 mm	tworzywo, plastic, пластмасса, Kunststoff, plasztik	5901867172648
LD-ZTL82M-2N600	8 mm / 600 LED		5902801001567
LD-ZTL102M-2N	10 mm		5901867172679
LD-ZTLRGB2M-4N	RGB		5901867172709



- PL Złączka XC11 do taśm LED z przewodem 2 m i mini amp
- EN Connector XC11 with 2 m cord and mini AMP, for LED strips
- RU Соединитель XC11 для лент LED, с проводом 2 м и мини amp
- DE Verbinder XC11 für LED-Streifen 8 mm mit Kabel 2 m
- HU XC11 csatlakozó LED szalaghoz 2 méteres vezetékkel és mini amp elosztóval

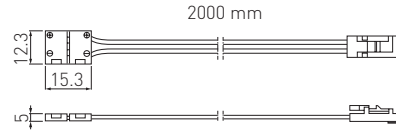

	INFO		
LD-ZTL8MMAMP-02N	8 mm	tworzywo, plastic, пластмасса, Kunststoff, plaszтик	5901867172792
LD-ZTL8MMAMP-02N600	8 mm / 600 LED		5902801001574



- PL Przedłużacz biurkowy wpuszczany ELITE
- EN Pull-out power socket ELITE
- RU Выдвижной настольный удлинитель ELITE
- DE Ausziehbarer Schreibtisch-Steckdosenleiste ELITE
- HU ELITE asztalba süllyeszthető elosztó



AE-BPWE3GU-00



AE-BPWE3S60U-00

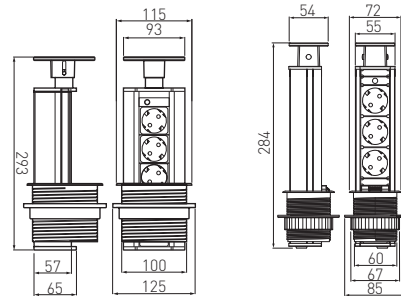

AE-BPWE3GS-00	100	3 x schuko	-	srebrny, silver, серебряный, silber, ezüst	aluminium, aluminium, алюминий, Aluminium, aluminium	5901867186812
AE-BPWE3GU-00		3 x french	-			5901867186799
AE-BPWE3S60-00	60	3 x schuko	-			5901867186737
AE-BPWE3S60U-00			5V USB			5901867186775
AE-BPWE3U60-00		3 x french	-			5901867186713
AE-BPWE3U60U-00			5V USB			5901867186751



PL Pokrywka i pierścień do przedłużaczy ELITE
 EN Cap and ring for pull-out power socket ELITE
 RU Крышка для удлинителя ELITE
 DE Deckel und Ring für Schreibtisch-Steckdosenleiste ELITE
 HU ELITE asztalba süllyeszthető elosztó



Folder	Ø mm	Material	Color	Barcode
AE-CAP100-40	100	chrom, chrome, хром, Chrom, króm	20	5901867186850
AE-CAP100-51		stal szczotkowana, brushed steel, шлифованная сталь, Edelstahloptik, Csiszolt fém		5901867186874
AE-CAP60-40	60	chrom, chrome, хром, Chrom, króm	70	5901867186836
AE-CAP60-51		stal szczotkowana, brushed steel, шлифованная сталь, Edelstahloptik, Csiszolt fém		5901867186898

PL Przedłużacz biurkowy wpuszczany okrągły ø 60
 EN Pull-out power socket – round ø 60
 RU Выдвижной настольный удлинитель, круглый ø 60
 DE Ausziehbarer Schreibtisch-Steckdosenleiste ø 60
 HU Asztalba süllyeszthető kerek elosztó, ø 60



AE-BPW3U60U-20

AE-BPW3U60-80

Folder	Ø mm	Ports	Material	Color	Barcode
AE-BPW3U60-20	60	3 x french	-	czarny, black, черный, schwarz, fekete	5908231395559
AE-BPW3U60-80				srebrny, silver, серебряный, silber, ezüst	5908231395566
AE-BPW3S60-20		3 x schuko	-	czarny, black, черный, schwarz, fekete	5908231395535
AE-BPW3S60-80				srebrny, silver, серебряный, silber, ezüst	5908231395542
AE-BPW3U60U-20		3 x french	5V USB	czarny, black, черный, schwarz, fekete	5901867130983
AE-BPW3U60U-80				srebrny, silver, серебряный, silber, ezüst	5901867131003
AE-BPW3S60U-20		3 x schuko	5V USB	czarny, black, черный, schwarz, fekete	5901867130945
AE-BPW3S60U-80				srebrny, silver, серебряный, silber, ezüst	5901867130969



- PL Przedłużacz biurkowy wpuszczany okrągły ø 100
- EN Pull-out power socket – round ø 100
- RU Выдвижной настольный удлинитель, круглый ø 100
- DE Ausziehbare Schreibtisch-Steckdosenleiste ø 100
- HU Asztalba süllyeszthető kerek elosztó, ø 100



Black

Silver

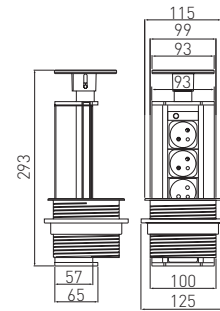

AE-BPW3GU-20	100	3 x french	czarny, black, черный, schwarz, fekete	aluminium, tworzywo aluminium, plastic алюминий, пластмасса Aluminium, Kunststoff aluminium, plasztk	5908231338815
AE-BPW3GU-80			srebrny, silver, серебряный, silber, ezüst		5908231338808
AE-BPW3GS-20		3 x schuko	czarny, black, черный, schwarz, fekete		5908231338839
AE-BPW3GS-80			srebrny, silver, серебряный, silber, ezüst		5908231338822



- PL Przedłużacz biurkowy wpuszczany prostokątny
- EN Rectangular pop-up power and connection socket
- RU Настольный удлинитель, прямоугольный, врезной
- DE Schreibtisch-Steckdosenleiste zum Einlassen, rechteckig
- HU Asztalba süllyeszthető négyzetes elosztó



AE-PB02GS-53



AE-PBC2GU-53

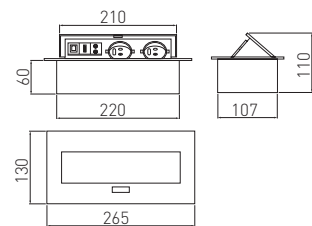

AE-BPW3GU-20	-	2 x schuko	aluminium, aluminium, алюминий, Aluminium, aluminium	stal, tworzywo steel, plastic сталь, пластмасса Stahl, Kunststoff acél, plasztk	5908231338815
AE-BPW3GU-80	-	2 x french			5908231338808
AE-BPW3GS-20	1,5 m	2 x french			5908231338839



PL Przedłużacz biurkowy wpuszczany prostokątny
 EN Rectangular pop-up power and connection socket
 RU Настольный удлинитель, прямоугольный, врезной
 DE Schreibtisch-Steckdosenleiste zum Einlassen, rechteckig
 HU Asztalba süllyeszthető négyzetleges elosztó



White

Black

Aluminium

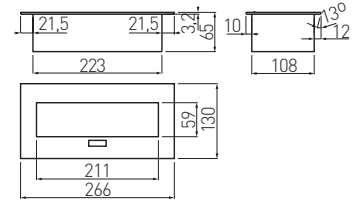

AE-PB03GS-53	-	3 x schuko	aluminium, aluminium, алюминий, Aluminium, aluminium	stal, tworzywo steel, plastic сталь, пластмасса Stahl, Kunststoff acél, plasztik	5908231362605
AE-PB03GU-53	-	3 x french			5908231337689
AE-PBC3GU-53	1,5 m	3 x french	5908231389121		
AE-PBC3GU-20	1,5 m	3 x french	czarny, black, черный, schwarz, fekete		5902801023385
AE-PBC3GU-10	1,5 m	3 x french	biały, white, белый, weiß, fehér		5901867130730



PL Przedłużacz biurkowy wpuszczany prostokątny
 EN Rectangular pop-up power and connection socket
 RU Настольный удлинитель, прямоугольный, врезной
 DE Schreibtisch-Steckdosenleiste zum Einlassen, rechteckig
 HU Asztalba süllyeszthető négyzetleges elosztó



White

Black

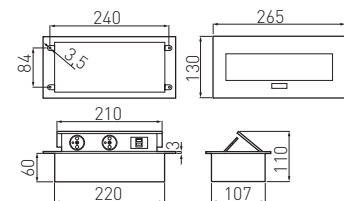

AE-PBU2GU-10	2 x french	biały, white, белый, weiß, fehér	stal, tworzywo steel, plastic сталь, пластмасса Stahl, Kunststoff acél, plasztik	5901867131010
AE-PBU2GU-20		czarny, black, черный, schwarz, fekete		5901867131034



PL Przedłużacz biurkowy kątowny
EN Corner power socket
RU Настольный удлинитель, угловой
DE Schreibtisch-Steckdosenleiste, eckig
HU Sarokba illeszthető asztali elosztó



AE-PBKT4S-80

AE-PBKT3U2U-80

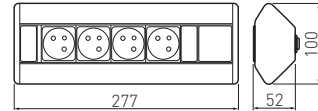

AE-PBKT4U-80	4 x french	-	srebrny, silver, серебряный, silber, ezüst	aluminium, tworzywo aluminium, plastic алюминий, пластмасса Aluminium, Kunststoff aluminium, plasztik	5901867162779
AE-PBKT4S-80	4 x schuko				5901867162786
AE-PBKT3U2U-80	4 x french	5V USB			5901867162793
AE-PBKT3S2U-80	4 x schuko				5901867162809



PL Przedłużacz biurkowy MULTI
EN Power socket MULTI
RU Настольный удлинитель MULTI
DE Schreibtisch-Steckdosenleiste MULTI
HU Asztali elosztó MULTI

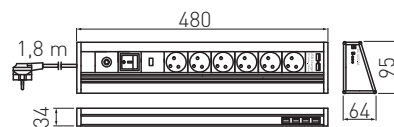

AE-PBMUL6U6U-53	6 x french	aluminium, aluminium, алюминий, Aluminium, aluminium	aluminium, tworzywo aluminium, plastic алюминий, пластмасса Aluminium, Kunststoff aluminium, plasztik	5901867196330
AE-PBMUL6S6U-53	6 x schuko			5901867196347



PL Przedłużacz biurkowy wpuszczany CHARGER
 EN Desk recessed power socket CHARGER
 RU Настольный удлинитель, встраиваемый CHARGER
 DE Schreibtisch-Steckdosenleiste CHARGER
 HU Asztalba süllyeszthető elosztó CHARGER

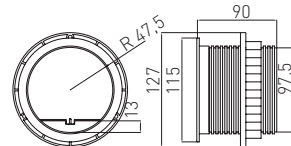

AE-BPW1S2UCH-80	100	1 x schuko	srebrny, silver, серебряный, silber, ezüst	tworzywo, plastic, пластмасса, Kunststoff, plasztik	5901867196439
AE-BPW1U2UCH-80		1 x french			5901867196422



PL Przedłużacz biurkowy bez kasety
 EN Through-desk power socket without housing
 RU Настольный удлинитель без корпуса
 DE Schreibtisch-Steckdosenleiste ohne Kasette
 HU Asztalba süllyeszthető elosztó, kazetta nélkül

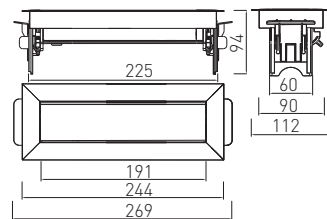

AE-PBC3GS-51BK	3 x schuko	stal szcztokowana brushed steel шлифованная сталь	stal, aluminium, tworzywo steel, aluminium, plastic	5901867196613
AE-PBC3GU-51BK	3 x french	Edelstahloptik Csiszolt fém	Stahl, Aluminium, Kunststoff acél, alumínium, plasztik	5901867196620



PL Przedłużacz biurkowy przepustowy z USB
 EN Through-desk power socket letterbox brush cable access with USB
 RU Настольный удлинитель с пропуском под кабель с USB
 DE Schreibtisch-Steckdosenleiste mit Kabeldurchführung
 HU Asztali elosztó USB-vel

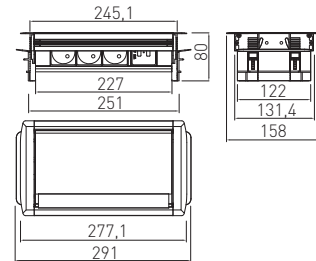

AE-PBC3GS-53BKS	3 x schuko	-	aluminium, aluminium, алюминий, Aluminium, aluminium	aluminium, tworzywo aluminium, plastic алюминий, пластмасса Aluminium, Kunststoff aluminium, plasztik	5901867196637
AE-PBC3GU-53BKS	3 x french				5901867196644
AE-PBC3GS2U-53BKS	3 x schuko	USB	aluminium, aluminium, алюминий, Aluminium, aluminium	aluminium, tworzywo aluminium, plastic алюминий, пластмасса Aluminium, Kunststoff aluminium, plasztik	5901867196651
AE-PBC3GU2U-53BKS	3 x french				5901867196668



PL Przedłużacz biurkowy przepustowy z HDMI
 EN Through-desk power socket letterbox brush cable access with HDMI port
 RU Настольный удлинитель с пропуском под кабель, с выходом HDMI
 DE Schreibtisch-Steckdosenleiste mit Kabeldurchführung, mit HDMI-Schnittstelle
 HU Asztali elosztó HDMI-vel

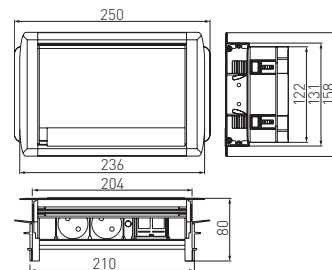

INFO



AE-PBC2GS1HDMI-53BKS	2 x schuko	1x HDMI	aluminium, aluminium, алюминий, Aluminium, aluminium	aluminium, tworzywo aluminium, plastic алюминий, пластмасса Aluminium, Kunststoff aluminium, plasztik	5902801025792
AE-PBC2GU1HDMI-53BKS	2 x french				5902801025808



Przewodnik po symbolach katalogu | Guide to catalog symbols | Условные обозначения Beschreibung der Symbole | Útmutató a katalógus szimbólumok

Ikony elektrotechniczne | Electrical engineering icons | Электротехнические иконки | Elektrotechnische Symbole | Elektrotechnika ikonok



Odpowiednik mocy
Wattage equivalent
Эквивалент мощности
Äquivalenzleistung
Egyenértékű teljesítmény



Prąd znamionowy
Lamp current
ток лампы
Lampenstrom
lámpa áram



Moc źródła światła lub urządzenia
Lamp /device power
Мощность источника света или устройства
Leistung der Lichtquelle oder des Gerätes
Fényforrás vagy berendezés teljesítménye



Strumień świetlny
Luminous flux
Луч свечения
Lichtstrom
Fényáram



Długość produktu
Product length
Длина изделия
Produktlänge
Termék hossza



Materiał obudowy produktu
Product casing material
Материал корпуса продукта
Material des Produktgehäuses
A termék házának plasztik



Kolor obudowy
Casing color
Цвет корпуса
Gehäusefarbe
A ház színe



Temperatura barwowa światła
Color temperature
Цветовая температура
Farbtemperatur des Lichts
Fény színhőmérséklete



Maksymalna ilość opraw do połączenia w linie
Maximum unit in line connection
Максимальное количество светильников для
подключения в линию
Maximale Anzahl der Leuchten, die in einer Linie
angeschlossen werden können
Maximális egység vonalkapcsolatban



Klasa energetyczna
Energy efficiency class
RU Класс энергоэффективности
DE Energieeffizienzklasse
HU energiahatékonysági osztály



Zasilanie
Voltage
Напряжение
Stromversorgung
Táp



Zasilanie napięciem 12 V prąd stały
12 V power supply DC
Напряжение питания 12 В постоянный ток
Stromversorgungsspannung von 12 V DC
12 V egyenáramú tápfeszültség



Zasilanie napięciem 12 V
12 V power supply
Напряжение питания 12 В
Stromversorgungsspannung von 12 V
12 V tápfeszültség



Napięcie wyjściowe
Output voltage
Выходное напряжение
Ausgangsspannung
Kimeneti feszültség



Maksymalne dopuszczalne obciążenie
Max permissible load
Максимально допустимая нагрузка
Maximale zulässige Belastung
Maximális megengedett terhelhetőség



Kąt świecenia
Beam angle
Угол свечения
Strahlungswinkel
Fénysugár szöge



Stopień ochrony IP
International protection marking
Пылевлагозащита IP
Schutzart IP
Védettségi szint



Czas pracy
Nominal lifetime
Время работы
Betriebszeit
Működési idő



Długość przewodu
Wire length
Длина провода
Kabellänge
Vezeték hossza



Długość przewodu z wtyczką
Length of cord with plug
Длина провода с вилкой
Länge des Kabels mit Stecker
Csatlakozóval ellátott vezeték hossza



Długość taśmy LED
LED strip length
Длина ленты LED
Länge des LED-Strips
LED szalagok hossza



Stopień ochrony IK
IK degree of protection
Пылевлагозащита IK
Schutzart IK
IK védettség



Waga
Weight
Вес
Gewicht
Súly



Rodzaj złączki
Type of connector
Тип соединителя
Steckverbindertyp
Csatlakozó típusa



Współczynnik oddawania barw
Colour rendering index
Индекс цветопередачи
Farbwiedergabeindex
Színvisszaadási index



Współczynnik mocy
Power factor
Фактор силы
Leistungsfaktor
Teljesítménytényező



Współczynnik oślnienia
Glare factor
Коэффициент ослепленности
Blendungskennzahl
Káprázási együttható



Czas włączania
Starting time (max)
Время включения
Einschaltzeit
Bekapcsolási idő



Liczba cykli wł/wył
Switching cycle
Количество циклов вкл./выкл.
Anzahl der Zyklen EIN / AUS
Be/ki ciklusok száma



Współpracuje ze ściemniaczami
Dimmable
Есть возможность подключения диммера
Für Dimmerbetrieb geeignet
Használható sötétítővel



Nie współpracuje ze ściemniaczami
Non-dimmable
Нет возможности подключения диммера
Nicht für Dimmerbetrieb geeignet
Nem használható sötétítővel



Rodzaj diody LED
Types of LED diode
Тип диодов LED
LED-Typ
LED dióda típusa



Ilość diod LED
Number of LED diodes
Количество диодов LED
Anzahl der LEDs
LED diódák száma



Dopuszczalna temperatura pracy
Allowable working temperature
Допустимая рабочая температура
Zulässige Betriebstemperatur
Megengedett munkahőmérséklet



Rodzaj świetlówki
Type of fluorescent tube
Тип люминесцентной лампы EVG
Typ der Leuchtstofflampe
Fénycső típusa



Przekrój przewodu
Wire cross section
Сечение провода
Kabelquerschnitt
Vezeték metszete



Maksymalny zasięg czujnika ruchu
Motion sensor range
Дальность датчика движения
Reichweite des Bewegungsmelders
Mozgásérzékelő tartomány



Kąt widzenia czujnika ruchu
Motion sensor detection angle
Угол обзора датчика движения
Erfassungswinkel des Bewegungsmelders
Mozgásérzékelő látási szöge



Zawartość rtęci
Mercury content
Содержание ртути
Quecksilbergehalt
Higanytartalom



Gniazdo Schuko
Schuko socket
Гнездо Schuko
Schuko-Steckdose
Schuko csatlakozó



Gniazdo French
French socket
Гнездо French
Steckdosen-Typ E
French csatlakozó



USB
USB port
USB-порт
USB-Buchse
USB port



Maksymalne obciążenie gniazd USB
Max load USB ports
Максимальное количество портов USB
Maximale Belastung des USB-Anschlusses
USB csatlakozók maximális terhelhetősége



Gniazdo UK
UK socket
Гнездо UK
Britische Steckdose
UK csatlakozó



Oprawa z włącznikiem
Fixture with switch
Светильник с выключателем
Gerät mit Schalter
Ház kapcsolóval



Wyłącznik termiczny
Thermal switch
Термовыключатель
Thermoschutzschalter
Termikus kikapcsoló



Rekomendowana odległość montażu od powierzchni
Recommended mounting distance from surfaces
Рекомендуется монтаж устройства на расстоянии
Empfohlener Montageabstand von der Oberfläche
Ajánlott szerelési távolság a felülettől



Średnica otworu montażowego
Mounting hole diameter
Монтажное отверстие диаметром
Durchmesser der Befestigungsbohrung
Szerelőnyílás átmérője



Statecznik EVG
Electrical ballast EVG
Пусковое устройство EVG
Vorschaltgerät EVG
EVG előtét



Brak efektu migotania
Flicker free
Нет мерцающего эффекта
Kein Flackereffekt
Villogásmentes



Możliwość montażu modułu awaryjnego CNBOP
Ready for emergency unit assembly
Возможность монтажа аварийного модуля CNBOP
Möglichkeit der Montage des Notfallsystems CNBOP
Sürgősségi egység összeszerelésre készen



Pojemność baterii
Battery capacity
Емкость аккумулятора
Batteriekapazität
Elem kapacitása



Typ Baterii
Battery type
Тип батареи
Batterieart
Elem típusa



Czujnik ruchu
Motion sensor
Датчик движения
Bewegungssensor
Mozgásérzékelő



Czujnik zmierzchowy
Twilight sensor
Датчик сумерек
Dämmerungssensor
Szürkületérzékelő



Długość przewodu z wtyczką mini AMP
Length of the cable with mini connector
Длина кабеля с мини-штекером AMP
Kabellänge mit Mini AMP
A kábel hossza mini csatlakozóval



Długość przewodu z zasilaczem
Length of the cable with driver
Длина кабеля с блоком питания
Kabellänge mit Trafo
A kábel hossza meghajtóval



Gniazdo RJ45
RJ45 socket
Гнездо RJ45
RJ45 Steckdose
RJ45 csatlakozó



Gniazdo ethernet
Ethernet socket
Гнездо ethernet
Ethernet Steckdose
Ethernet csatlakozó



Gniazdo HDMI
HDMI socket
Гнездо HDMI
HDMI Steckdose
HDMI csatlakozó



Ilość gniazd
Number of sockets
Количество розеток
Anzahl der Steckdose
Csatlakozó száma



Klasa ochronności I
Protection class I
I класс защиты
Schutzklasse I
I. védelmi osztály



Klasa ochronności II
Protection class II
II класс защиты
Schutzklasse II
II. védelmi osztály



Klasa ochronności III
Protection class III
III класс защиты
Schutzklasse III
III. védelmi osztály



Kostka przyłączeniowa - maksymalny przekrój przewodu
Terminal block - maximum cable cross section
Винтовой зажим - максимальное сечение кабеля
Anschlussblock - maximaler Kabelquerschnitt
Csatlakozási blokk - maximális kábel keresztmetszete



Maksymalny horyzont kąta działania czujnika
Maximum sensor angle operation
Максимальный горизонт угла наклона датчика
Maximale Reichweite des Arbeitswinkels des Sensors
A szenzor maximális szögének működése



Maksymalny prąd obciążenia
Maximum current load
Максимальный ток нагрузки
Maximaler Laststrom
Maximális áramterhelés



Miejsce montażu
Place of assembly
Место монтажа
Montageort
Összeszerelési hely



Montaż natynkowy
Surface mounting
Поверхностный монтаж
Aufputzmontage
Falra szerelendő



Montaż wpuszczany
Flush mount
Скрытый монтаж
Unterputzmontage
Süllyesztett beszerelés



Czujnik jednobiegowy
Single-pole sensor
Однополюсный датчик
Schranktür-Schalter
Egypólusú érzékelő



Czujnik dwubiegowy
Double-pole sensor
Двухполюсный датчик
Bewegungsschalter
Kétpólusú érzékelő



Zabezpieczenie przepięciowe
Overvoltage protections
Защита от перенапряжения
Überspannungsschutz
Tűlfeszültség-védelem



Mikrofalowy czujnik ruchu
Microwave motion sensor
Датчик движения СВЧ
Mikrowellen-Bewegungsmelder
Mikrohullámú mozgásérzékelő



3 sposoby świecenia: (zewn, wewn, zewn+wewn)
3 types of lighting: (outside, inside, outside + inside)
3 способа свечения: (внешн, внутр, внешн+внутр)
3 Möglichkeiten für die Beleuchtung: (extern, intern, extern + intern)
3 világítási mód: (külső, belső, külső+belső)



Czujnik ruchu IR
Motion Sensor IR
Датчик движения ИК
IR-Bewegungssensor
A mozgásérzékelő infravörös



3-stopniowy czujnik ruchu
3 step motion sensor
3 шаг датчик движения
3-stufiger Bewegungsmelder
3. lépés mozgásérzékelő



3 tryby załączania źródła światła
3 modes for lamp switch on
3 режима включения лампочки
3 Lichtquellen-Schaltmodi
3 fényforrás-bekapcsolási mód



3-stopniowa regulacja jasności
3 step brightness adjustment
Регулировка яркости на 3 шага
3-stufige Helligkeitseinstellung
3 fokozatú fényerő beállítása



2 tryby załączania źródła światła
2 modes for lamp switch on
2 режима включения лампочки
2 Lichtquellen-Schaltmodi
2 fényforrás-bekapcsolási mód



Opcja ściemniania
Dimmable
Диммируемый
Dimmfähige Variante
Fényerősség szabályozható

Ikony elektrotechniczne pozostałe - rodzaj trzonka
Electrical engineering icons – base type
Электротехнические иконки – тип цоколя
Sonstige elektrotechnische Symbole - Sockettypen
Elektrische Icons - Basistyp

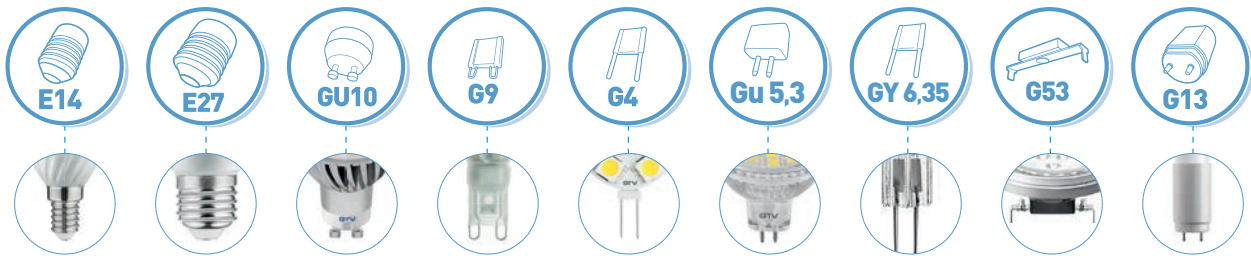

Na zamówienie wersja DALI
On DALI order
По заказу DALI
Auf Bestellung Version DALI
Megrendelésre DALI változat



Na zamówienie oprawa przystosowana do częstego załączania np. współpraca z czujkami ruchu.
On request a luminaire adapted for cooperation with motion sensors
По заказу светильник предназначенный для работы с датчиками движения
Auf Bestellung: Gerät geeignet für Einsatz mit Bewegungsmeldern
Megrendelésre mozgásérzékelőkkel együttműködő lámpatest



Maksymalna ilość opraw do połączenia w linie
Maximum unit in line connection
Максимальное количество светильников для подключения в линию
Maximale Anzahl der Leuchten, die in einer Linie angeschlossen werden können
Maximális egység vonalkapcsolatban



Piktogramem oznaczone są łączniki, w których można podłączyć zasilanie szynoprzewodu.
The pictogram are marked connectors, which you can connect the power supply to 3-circuit track.
Пиктограммой обозначены соединители, в которых можно подключить питание шинпровода.
Die Anschlüsse, an die man Stromversorgung anschließen kann, sind mit einem Piktogramm versehen.
A piktogramon jelölve vannak a csatlakozók, amelyekre csatlakozni lehet a tápegységet a 3-körös sávhoz



Możliwość podłączenia bez użycia narzędzi
No-tool connection option
Возможность подключения без инструментов
Möglichkeit einer Montage ohne Werkzeug
Szerszám nélküli csatlakozási lehetőség



Maksymalna rozpraszana moc źródeł światła dla profilu rozgrzanego do maksymalnie 65 stopni C, dla wersji z kloszem.*
Maximal dissipated power of lamps for heated profiles to 65°C, when applied with lampshades.*
Максимальная рассеиваемая мощность источников света для нагреваемого профиля до максимум 65°C, для версии с абажуром.*
Maximale Verlustleistung der Leuchtmittel für ein beheiztes Profil bis maximal 65°C für die Version mit Abdeckung.*
A lámpák maximális eloszlatott teljesítménye melegített profilok esetén 65°C-ra, lámpabúra alkalmazása esetén.*



Brak efektu migotania
Flicker free
Нет мерцающего эффекта
Kein Flackereffekt
Villogásmentes



Współpracuje z modulem awaryjnym
Emergency module compatible
Работает с модулем аварийного питания
Funktioniert mit dem Notfallmodul
Sürgősségi modul kompatibilis



Ładowanie bezprzewodowe
Wireless charging
Беспроводная зарядка
Kabelloses Laden
Vezeték nélküli töltés

* Rzeczywiste wartości mocy, strumienia świetlnego, temperatury barwowej mogą się różnić w granicach ±5% od podanych wartości. Maksymalna temperatura otoczenia dla powyższych wyników wynosi 24 stopnie C. Kompatybilność taśmy LED z profilem LED zależy od sposobu oraz miejsca montażu.
Real power value, luminous flux, colour temperature may vary within 5% of stated values. Maximal temperature of surroundings for above results is 24°C. Compatibility of LED tape and LED profile depends on a method and place of assembling.
Фактические значения мощности, светового потока, цветовой температуры могут варьироваться в пределах ± 5% от заданных значений. Максимальная температура окружающей среды для вышеуказанных показателей составляет 24°C. Совместимость светодиодной ленты со светодиодным профилем зависит от способа и места установки.
Die tatsächlichen Werte für Leistung, Lichtstrom und Farbtemperatur können von den angegebenen Werten um ± 5% abweichen. Die maximale Umgebungstemperatur für die oben genannten Werte beträgt 24°C. Die Kompatibilität des LED-Streifens mit dem LED-Profil hängt von der Montageart und vom Installationsort ab.
Valódi teljesítményérték, fényáram, színhőmérséklet a megadott értékek 5%-án belül változhat. Maximális környék hőmérséklet 24°C, a fenti eredmények esetén.
A LED-szalag és a LED-profil kompatibilitása az összeszerelés módjától és helyétől függ.

A

AE-27GU10-00 258
 AE-BPW1S2UCH-80 332
 AE-BPW1U2UCH-80 332
 AE-BPW3GS-20 329
 AE-BPW3GS-80 329
 AE-BPW3GU-20 329
 AE-BPW3GU-80 329
 AE-BPW3S60-20 328
 AE-BPW3S60-80 328
 AE-BPW3S60U-20 328
 AE-BPW3S60U-80 328
 AE-BPW3U60-20 328
 AE-BPW3U60-80 328
 AE-BPW3U60U-20 328
 AE-BPW3U60U-80 328
 AE-BPWE3GS-00 327
 AE-BPWE3GU-00 327
 AE-BPWE3S60-00 327
 AE-BPWE3S60U-00 327
 AE-BPWE3U60-00 327
 AE-BPWE3U60U-00 327
 AE-CANOPY-10 262
 AE-CAP60-40 328
 AE-CAP60-51 328
 AE-CAP100-40 328
 AE-CAP100-51 328
 AE-CM3M00-00 244
 AE-CM1000-00 243
 AE-CM1500-00 246
 AE-CM3000-00 244
 AE-CM4000-00 245
 AE-CM5000-00 245
 AE-CM9000-00 246
 AE-CM9000-10 246
 AE-E14E27-00 258
 AE-E14GU10-00 257
 AE-E14RING-10 259
 AE-E27E14-00 258
 AE-E27RING-10 259
 AE-E40E27-00 259
 AE-GU10E27-00 259
 AE-OCEE14-00 255
 AE-OCEE27-00 256
 AE-OCEF27-00 255
 AE-OCHT27-00 256
 AE-OPE27K-00 256
 AE-OPE27P-00 257
 AE-PB03GS-53 330
 AE-PB03GU-53 330
 AE-PBC2GS1HDMI-53BKS... 333
 AE-PBC2GU1HDMI-53BKS... 333
 AE-PBC3GS2U-53BKS 333
 AE-PBC3GS-51BK 332
 AE-PBC3GS-53BKS 333
 AE-PBC3GU2U-53BKS 333
 AE-PBC3GU-10 330
 AE-PBC3GU-20 330

AE-PBC3GU-51BK 332
 AE-PBC3GU-53 330
 AE-PBC3GU-53BKS 333
 AE-PBKT3S2U-80 331
 AE-PBKT3U2U-80 331
 AE-PBKT4S-80 331
 AE-PBKT4U-80 331
 AE-PBMUL6S6U-53 331
 AE-PBMUL6U6U-53 331
 AE-PBU2GU-10 330
 AE-PBU2GU-20 330
 AE-PF3G1M-00 250
 AE-PF3G3M-00 250
 AE-PF3G5M-00 250
 AE-PF5G3M-00 250
 AE-PF5G5M-00 250
 AE-PFBEBEN-20 251
 AE-PFBEBEN-40 251
 AE-POGRODUN-10 252
 AE-POGRODUN-20 252
 AE-POGRODUN-30 252
 AE-PS3G3M-00 250
 AE-PS3G5M-00 250
 AE-PS4G3M-00 250
 AE-PS4G5M-00 250
 AE-PS5G3M-00 250
 AE-PS5G5M-00 250
 AE-RU0102-00 253
 AE-RU0103-00 255
 AE-RU0121-00 253
 AE-SBEBEN-30 251
 AE-SBEBEN-50 251
 AE-SC0102-00 254
 AE-SC0103-00 254
 AE-SRC812-00 247
 AE-SRC812-MIN 247
 AE-VA1UNI-00 254
 AE-WBBUNI-10DIM 319
 AE-WBCUNI-10DIM 319
 AE-WBEZDB-10S 317
 AE-WBEZDC-10S 317
 AE-WBEZDK15-10 317
 AE-WBEZD-NB 320
 AE-WBEZDPIR2-20 318
 AE-WBEZDPIR-10 318
 AE-WDSB-10DIM 319
 AE-WDSC-10DIM 319
 AE-WLB01-10 321
 AE-WLC01-20 321
 AE-WLIP44-15 322
 AE-WLKON-20 323
 AE-WLLAN1-10 322
 AE-WLLAN1-20 322
 AE-WLLAN1-90 322
 AE-WLPR-60 321
 AE-WLPR-60P2 321
 AE-WLSZN1-10 322
 AE-WPDRW-00 320
 AE-ZLADPOD-20 316

AE-ZUSB-20 315

C

CR-CO1000-00 241
 CR-CR3M00-00 237
 CR-CR4L00-00 238
 CR-CR5M00-00 239
 CR-CR1000-00 236
 CR-CR1000-10 236
 CR-CR1100-00 241
 CR-CR2000-00 236
 CR-CR2000-10 236
 CR-CR3000-00 237
 CR-CR5000-00 238
 CR-CR6000-00 239
 CR-CR7000-00 240
 CR-CR9000-00 240
 CR-CR9000-10 240
 CR-CR13000-00 242
 CR-CR15000-00 242
 CR-CR16000-00 243
 CZ-CZ1000-00 248
 CZ-CZ2000-00 248

G

GZ-E27000-00 257
 GZ-E27000-10 257
 GZ-G13-0000 252
 GZ-G90000-00 253
 GZ-GZ10-0000 252
 GZ-MR16-0000 252

H

HL-G90000-20 47
 HL-G90000-35 47
 HL-G90000-40 47
 HL-G90000-50 47
 HL-GU1038-35 47
 HL-J11800-10 48
 HL-JCG400-10 48
 HL-JCG400-20 48
 HL-JCG530-35 48
 HL-JCG530-50 48

K

KB-W310HUG-20 263
 KB-W313HUG-20 263

L

LB-GAL3WRU-10 209
 LB-GAL5WMO-10 210
 LB-GAL5WRU-10 209
 LD-3SCTA60-10W 28
 LD-3SDA60-10W 28
 LD-3SDA606-10W 28
 LD-3SKL-CBN 308

LD-3SKL-NBN 308
 LD-3SKL-ZBN 308
 LD-120G14W-32 35
 LD-120G18W-32 35
 LD-2835-300-20-CB 272
 LD-2835-300-20-CB-50 273
 LD-2835-300-20-NE 272
 LD-2835-300-20-NE4P 272
 LD-2835-300-20-NE4P-50 273
 LD-2835-300-20-NE-50 273
 LD-2835-300-20-ZB 272
 LD-2835-300-20-ZB-50 273
 LD-2835-300-65-CB 272
 LD-2835-300-65-ZB 272
 LD-3528-300-20-CB 272
 LD-3528-300-20-CB-50 273
 LD-3528-300-20-NE 272
 LD-3528-300-20-NE4P 272
 LD-3528-300-20-NE4P-50 273
 LD-3528-300-20-NE-50 273
 LD-3528-300-20-NI 272
 LD-3528-300-20-ZB 272
 LD-3528-300-20-ZB-50 273
 LD-3528-300-65-CB 272
 LD-3528-300-65-ZB 272
 LD-3528-600-20-CB 272
 LD-3528-600-20-ZB 272
 LD-3528-600-65-CB 272
 LD-3528-600-65-ZB 272
 LD-3528B-300-20-CB 273
 LD-3528B-300-20-ZB 273
 LD-3528B-300-65-CB 273
 LD-3528B-300-65-ZB 273
 LD-5050-300-20-CB 272
 LD-5050-300-20-ZB 272
 LD-5050-300-65-CB 272
 LD-5050-300-65-ZB 272
 LD-5630-300-20-CB 272
 LD-5630-300-20-ZB 272
 LD-5630-300-65-CB 272
 LD-5630-300-65-ZB 272
 LD-A60CM3-10W 4, 27
 LD-A60CM4-10W 27
 LD-A60CZ3-10W 27
 LD-A60CZ4-10W 27
 LD-A60FL8-30 32
 LD-A60FL8M-30 31
 LD-AB18CB-53 303
 LD-AB18ZB-53 303
 LD-AKO4060-NB 60
 LD-AL7A60-20W 31
 LD-AL24CB-53 294
 LD-AL24NE-53 294
 LD-AL24ZB-53 294
 LD-ALF100-30W 36
 LD-ALF120-40W 36
 LD-ALF140-50W 37
 LD-AR11120-30 43
 LD-AR11145-30* 43

LD-ATL16KW-40.....	79	LD-FL36CB-00.....	305	LD-ILUXC100W-64.....	113	LD-LU16ZB-10.....	288
LD-ATL16OK-40.....	78	LD-FL36ZB-00.....	305	LD-ILUXCC10W-64.....	112	LD-LU16ZB-20.....	288
LD-ATO18W-40.....	87	LD-FO120CB-40.....	301	LD-ILUXCC20W-64.....	112	LD-LU16ZB-53.....	288
LD-BA2E27-00.....	204	LD-FO120ZB-40.....	301	LD-ILUXCC30W-64.....	112	LD-LUG119-40.....	290
LD-BA2GU10-0M.....	204	LD-G4P35W-30.....	43	LD-ILUXCC50W-64.....	112	LD-LUG119-52.....	290
LD-BALE27-00.....	204	LD-G4P35W-40.....	43	LD-ILUXCC100W-64.....	113	LD-LUG119-53.....	290
LD-BALGU10-0S.....	204	LD-G4SI15-32.....	43	LD-IMAXC200W-64.....	113	LD-LUG319-40.....	297
LD-BERGA50W-30.....	67	LD-G4SI15-45.....	43	LD-INEXT10W-64.....	111	LD-LUG319-52.....	297
LD-BERGA70W-30.....	67	LD-G9P5W0-30.....	39	LD-INEXT20W-64.....	111	LD-LUG319-53.....	297
LD-BES24WKW-40.....	77	LD-G9P5W0-40.....	39	LD-INEXT30W-64.....	111	LD-LUM120-30P.....	73
LD-BES24WOK-40.....	77	LD-G9P7W0-30.....	39	LD-INEXT30WP-64.....	112	LD-LUM150-30P.....	73
LD-BETISD50W-30.....	67	LD-G9P7W0-40.....	39	LD-INEXT50W-64.....	111	LD-MA45060-NB.....	60
LD-BETISD70W-30.....	67	LD-G9P35W-30.....	38	LD-INEXT50WP-64.....	112	LD-MA45120-NB.....	60
LD-BLRKW18W-61.....	100	LD-G9P35W-40.....	38	LD-IRUSB-53.....	306	LD-MAG36W0-40.....	68
LD-BLRK18W-61.....	100	LD-G45FL4-30.....	25	LD-IS09CB-53.....	293	LD-MAG45W0-40.....	68
LD-BOS1CBWB-53.....	307	LD-G45FL4M-30.....	25	LD-IS09NE-53.....	293	LD-MAGCMS-10.....	68
LD-BOS1CBWG-53.....	307	LD-G93W24-32.....	38	LD-IS09ZB-53.....	293	LD-MAN07W-CBP.....	97
LD-C35FL4-30.....	23	LD-G93W24-45.....	38	LD-J7806W-40.....	37	LD-MAN07W-NBP.....	97
LD-C35FL4-30L.....	24	LD-G93W25-30.....	39	LD-J11810W-40.....	37	LD-MAN13W-CBP.....	97
LD-C35FL4M-30.....	22	LD-G93W25-40.....	39	LD-KABE2M-00.....	263	LD-MAN13W-NBP.....	97
LD-C35FL4M-30L.....	24	LD-G95FL8-30.....	32	LD-KABE2M-10.....	263	LD-MAN19W-CBP.....	97
LD-CHIC16NE-10.....	306	LD-G95FV4-30.....	34	LD-KALU100K-40.....	90	LD-MAN19W-NBP.....	97
LD-CHIC16NE-20.....	306	LD-G125FL8-30.....	32	LD-KALU100W-40.....	90	LD-MAN24W-CBP.....	97
LD-CO20CB-53.....	303	LD-G125FV4-30.....	34	LD-KJVC0B-CB.....	289	LD-MAN24W-NBP.....	97
LD-CO20ZB-53.....	303	LD-G4015W-30.....	44	LD-KJVC0B-ZB.....	289	LD-MAW03W-CBP.....	97
LD-CS36CB-53.....	291	LD-G4020W-30.....	44	LD-KLPCB-00N.....	307	LD-MAW03W-NBP.....	97
LD-CS36NE-53.....	291	LD-G96440-32.....	38	LD-KLPNB-00N.....	307	LD-MAW07W-CBP.....	97
LD-CS36ZB-53.....	291	LD-G96440-45.....	38	LD-KLPZB-00N.....	307	LD-MAW07W-NBP.....	97
LD-CSN36CB-53.....	291	LD-GL40060-NB.....	58	LD-KNG24063-CB.....	61	LD-MAW13W-CBP.....	97
LD-CSN36ZB-53.....	291	LD-GL40060-NBS.....	58	LD-KNG24063-NB.....	61	LD-MAW13W-NBP.....	97
LD-DE40062-NB.....	62	LD-GL40060UGR-NB.....	58	LD-KNG42060-CB.....	61	LD-MAW19W-CBP.....	97
LD-DELOR6W0-NB.....	92	LD-GL40060UGR-NBS.....	58	LD-KNG42060-NB.....	61	LD-MAW19W-NBP.....	97
LD-DELOR6WC-NB.....	93	LD-GL40120-NB.....	58	LD-KNG42312-CB.....	61	LD-MAW24W-CBP.....	97
LD-DELOW6W0-NB.....	92	LD-GL40120-NBS.....	58	LD-KNG42312-NB.....	61	LD-MAW24W-NBP.....	97
LD-DELOW6WC-NB.....	93	LD-HAG136-30.....	137	LD-KNG45060-NB.....	61	LD-MAX60CB-40N.....	302
LD-DIMLED2-10.....	312	LD-HAG158-30.....	137	LD-KNG45312-NB.....	61	LD-MAX60ZB-40N.....	302
LD-DIMLED-10.....	312	LD-HAG218-30.....	137	LD-KONMINI-RGB.....	313	LD-ML1000-00.....	270
LD-E14P35W-30.....	26	LD-HAG236-30.....	137	LD-KONRGB-00.....	314	LD-ML2000-00.....	270
LD-E14S2W0-40.....	26	LD-HAG236KL-ME.....	140	LD-KWP27CB-53.....	298	LD-ML3000-00.....	271
LD-EIW09CB-CZ.....	304	LD-HAG258-30.....	137	LD-KWP27ZB-53.....	298	LD-ML4000-00.....	271
LD-EMP22W-40.....	80	LD-HB150W-40.....	115	LD-LCG119-40.....	290	LD-ML5000-00.....	271
LD-EMP22W-40KW.....	80	LD-HBM050W-40.....	117	LD-LCG119-52.....	290	LD-MOON12W-NB.....	78
LD-ENZ20W-40.....	82	LD-HBM100W-40.....	117	LD-LCG119-53.....	290	LD-MOON18W-NB.....	78
LD-ES21ZB-53N.....	292	LD-HBN150W-40.....	117	LD-LCG319-40.....	297	LD-MZ12WKW-NB.....	98
LD-ES11100-30*.....	42	LD-HEK236-30.....	139	LD-LCG319-52.....	297	LD-MZ12WOK-NB.....	98
LD-ES11101-30.....	42	LD-HEK258-30.....	139	LD-LCG319-53.....	297	LD-MZ18WKW-NB.....	98
LD-ES11101-40.....	42	LD-HEL136B-30.....	138	LD-LL27CB-00.....	298	LD-MZ18WOK-NB.....	98
LD-ES11110-30*.....	42	LD-HEL136BPC-30.....	138	LD-LL27ZB-00.....	298	LD-NESSAGU10D-20.....	202
LD-ES11115-30.....	42	LD-HEL218B-30.....	138	LD-LOG16W-LED.....	88	LD-NESSAGU10D-80.....	202
LD-ES11115-40.....	42	LD-HEL218BPC-30.....	138	LD-LOTB-ME.....	140	LD-NESSAGU10J-20.....	202
LD-ES11175-30.....	42	LD-HEL236B-30.....	138	LD-LOTU218-30.....	137	LD-NESSAGU10J-80.....	202
LD-ES11175-40.....	42	LD-HEL236BPC-30.....	138	LD-LOTU236-30.....	137	LD-NGU10P-3W.....	40
LD-ES11177-30*.....	42	LD-HEL258B-30.....	138	LD-LOTU258-30.....	137	LD-NGU10P-4W.....	40
LD-ESKA084-51.....	159	LD-HEL258BPC-30.....	138	LD-LU16CB-10.....	288	LD-NGU10PN-1W.....	40
LD-ESKB084-51.....	159	LD-HER50W12-NB.....	70	LD-LU16CB-20.....	288	LD-NKW18CB-40.....	305
LD-ESOA084-51.....	158	LD-ILUXC10W-64.....	112	LD-LU16CB-53.....	288	LD-NKW18ZB-40.....	305
LD-ESOB084-51.....	158	LD-ILUXC20W-64.....	112	LD-LU16NE-10.....	288	LD-NO24CB-00.....	304
LD-FAR10W-40.....	108	LD-ILUXC30W-64.....	112	LD-LU16NE-20.....	288	LD-NO24ZB-00.....	304
LD-FAR20W-40.....	108	LD-ILUXC50W-64.....	112	LD-LU16NE-53.....	288	LD-NPCT809W-40.....	74

LD-NPCT818W-40.....74	LD-PARK50W-40.....119	LD-SMGC30B-60.....22	LD-VIPERS30W-40.....111
LD-NPCT818W-BL.....74	LD-PC2A60-6W.....30	LD-SMGC30C-60.....35	LD-VIPERS50W-40.....111
LD-NPCT818W-GR.....74	LD-PC2A60-12.....30	LD-SMGC30L-60.....23	LD-VIPERS100W-40.....111
LD-NPCT818W-RD.....74	LD-PC2A60RGBW-8W.....28	LD-SO206W-NB.....104	LD-VIPERS150W-40.....111
LD-NPCT836W-40.....74	LD-PC3A60-10W.....30	LD-SO212W-NB.....104	LD-VLRKW0538-CB.....106
LD-OBP27CB-53.....297	LD-PC3A60-15W.....31	LD-SO218W-NB.....104	LD-VLRKW1038-CB.....106
LD-OBP27ZB-53.....297	LD-PC6010-30.....41	LD-SO224W-NB.....104	LD-VLROK0538-CB.....106
LD-OJVCOB-CB.....289	LD-PC6010-40.....41	LD-SR16CB-53.....301	LD-VLROK1038-CB.....106
LD-OJVCOB-ZB.....289	LD-PC6010-64.....41	LD-SR16NE-53.....301	LD-WEND13W-40.....86
LD-OLL20W-NB.....73	LD-PC7510-30.....41	LD-SR16ZB-53.....301	LD-WEND18W-40.....86
LD-OLL40W-NB.....73	LD-PC7510-40.....41	LD-ST64FV4-30.....34	LD-WEND24W-40.....86
LD-OLL50W-NB.....73	LD-PC7510-64.....41	LD-STEL080W-40.....119	LD-WENDM18W-40.....86
LD-OMN060-30B.....72	LD-PIRUSB-53.....306	LD-STEL150W-40.....119	LD-WENDM24W-40.....86
LD-OMN120-60B.....72	LD-PJVCOB-CB.....290	LD-SZ1510-30.....40	LD-WENUSD13-LED.....85
LD-OMN120-75M.....72	LD-PJVCOB-ZB.....290	LD-SZ1510-40.....40	LD-WL2457-53.....299
LD-OMN150-70B.....72	LD-PN2A60-12.....30	LD-SZ1510-64.....40	LD-WZA20W-NW.....312
LD-OMN150-90M.....72	LD-PN3A60-10W.....30	LD-SZ5010-30.....40	LD-WZA36W-NW.....312
LD-OP408C-53.....299	LD-PN3A60-15W.....31	LD-SZ5010-40.....40	LD-WZA60W-NW.....312
LD-OP456C-53.....300	LD-PR24063-NB.....62	LD-SZ5010-64.....40	LD-WZA80W-NW.....312
LD-OP608C-53.....299	LD-PR36060-NB.....62	LD-TIAGOGU10D-01.....205	LD-WZA150W-NW.....312
LD-OP609C-53.....300	LD-PR40060-NB.....62	LD-TIAGOGU10D-20.....205	LD-Z3CSCB-53.....296
LD-OPD5W0-CB.....300	LD-PR40120-NB.....62	LD-TIAGOGU10J-01.....205	LD-Z5CSCB-53.....296
LD-OPD9W0-CB.....300	LD-PR45060-NB.....62	LD-TIAGOGU10J-20.....205	LD-Z5OTCB-51.....295
LD-OPT30S-51N.....295	LD-PR52060-NB.....62	LD-TK100W-40.....116	LD-ZAC6WDE-RGB.....314
LD-OPT30S-52N.....295	LD-PR52120-NB.....62	LD-TOK16WP-40.....84	LD-ZAS06W-30N.....309
LD-OPT30S-53N.....295	LD-PZ2A60-12.....30	LD-TOR08W-NB.....108	LD-ZAS12W-30N.....309
LD-OPT60S-51N.....295	LD-PZ3A60-10W.....30	LD-TOR12W-NB.....108	LD-ZAS15W-30N.....309
LD-OPT60S-52N.....295	LD-R5060W-30.....26	LD-TOR20W-NB.....108	LD-ZAS30W-30N.....309
LD-OPT60S-53N.....295	LD-R6380W-30.....27	LD-TOR24W-NB.....108	LD-ZAS50W-30N.....309
LD-ORN07W-CBP.....95	LD-RA60CB-40N.....302	LD-TR24CB-53.....294	LD-ZAS75W-30.....309
LD-ORN07W-NBP.....95	LD-RA60ZB-40N.....302	LD-TR24ZB-53.....294	LD-ZASPU15W-30N.....310
LD-ORN13W-CBP.....95	LD-RGB-150-20.....272	LD-TWI10WOK-40.....91	LD-ZL5RGB150-00.....315
LD-ORN13W-NBP.....95	LD-RGB-150-65.....272	LD-TWI10WOW-40.....91	LD-ZSKL15-00.....310
LD-ORN19W-CBP.....95	LD-SAHER1-DUO.....123	LD-TWN09W-CB.....102	LD-ZTK8MM-02N.....326
LD-ORN19W-NBP.....95	LD-SAHER3-DUO.....123	LD-TWN16W-CB.....102	LD-ZTK8MM-02N600.....326
LD-ORN24W-CBP.....95	LD-SATU45W-NB.....79	LD-TWW09W-CB.....102	LD-ZTK10MM-02N.....326
LD-ORN24W-NBP.....95	LD-SILVAGU10D-20.....203	LD-TWW16W-CB.....102	LD-ZTKT8MM-02N.....325
LD-ORW03W-CBP.....95	LD-SILVAGU10D-80.....203	LD-UFO18W-30.....36	LD-ZTKT8MM-02N600.....325
LD-ORW03W-NBP.....95	LD-SILVAGU10J-20.....203	LD-VA24CB-10.....288	LD-ZTKT10MM-02N.....325
LD-ORW07W-CBP.....95	LD-SILVAGU10J-80.....203	LD-VA24CB-20.....288	LD-ZTKTRGB-04N.....325
LD-ORW07W-NBP.....95	LD-SM1210-10.....41	LD-VA24CB-53.....288	LD-ZTL8MM-02N.....325
LD-ORW13W-CBP.....95	LD-SM4016-30.....44	LD-VA24NE-10.....288	LD-ZTL8MM-02N600.....325
LD-ORW13W-NBP.....95	LD-SM4016-64.....44	LD-VA24NE-20.....288	LD-ZTL8MMAMP-02N.....327
LD-ORW19W-CBP.....95	LD-SM6016-30*.....44	LD-VA24NE-53.....288	LD-ZTL8MMAMP-02N600.....327
LD-ORW19W-NBP.....95	LD-SMB45B-80.....25	LD-VA24ZB-10.....288	LD-ZTL10MM-02N.....325
LD-ORW24W-CBP.....95	LD-SMBD45-80.....35	LD-VA24ZB-20.....288	LD-ZTL82M-2N.....326
LD-ORW24W-NBP.....95	LD-SMBKW09W-21.....99	LD-VA24ZB-53.....288	LD-ZTL82M-2N600.....326
LD-OSSLKD2W-80.....161	LD-SMBKW16W-21.....99	LD-VE15CB-53.....292	LD-ZTL102M-2N.....326
LD-OSSLKW4W-80.....161	LD-SMBKW24W-21.....99	LD-VE15CBZB-53.....293	LD-ZTLRGB2M-4N.....326
LD-OSSL0D2W-80.....162	LD-SMBOK09W-21.....99	LD-VE15NE-53.....292	LD-ZTLRGB-04N.....325
LD-OSSLOW3W-80.....162	LD-SMBOK16W-21.....99	LD-VE15ZB-53.....292	LD-ZWND6W-10.....311
LD-OSSLPA2W-80.....160	LD-SMBOK20W-21.....99	LD-VE2060N-25.....63	LD-ZWND12-10.....311
LD-OSSLPB1W-80.....160	LD-SMC37L-80.....23	LD-VE2120N-50.....63	LD-ZZAS06KD6.....311
LD-OZE218-00.....135	LD-SMDC37-80.....22	LD-VE4060N-50.....63	LD-ZZAS12KD6.....311
LD-OZE218-01.....135	LD-SMGB45B-30.....24	LD-VE4060W-50.....63	LD-ZZAS15KD6.....311
LD-OZE236-00.....135	LD-SMGB45B-60.....24	LD-VEW06W-CB.....104	LD-ZZAS30KD6.....311
LD-OZE236-01.....135	LD-SMGB45C-60.....36	LD-VEW12W-CB.....104	LK-PANELX4-00.....64
LD-PARK30W-40.....119	LD-SMGC30B-30.....22	LD-VEW18W-CB.....104	LP-BENFICA2-80.....210

Niniejszy katalog produktów został przygotowany przez GTV Poland. Poprzez ciągłe udoskonalanie swojej oferty, zgodnie z wymogami rynkowymi i prawnymi, GTV Poland zastrzega sobie prawo do wprowadzania zmian w przedstawionym asortymencie. Prezentowana publikacja nie jest ofertą w rozumieniu Kodeksu Cywilnego. Rzeczywiste produkty mogą odbiegać od poglądowych zdjęć i rysunków zamieszczonych w publikacji. GTV Poland zastrzega sobie prawo do zmian i błędów w druku.

This product catalogue has been prepared by GTV Poland. Constantly improving its products so as to follow market and legal requirements, GTV Poland reserves the right to introduce changes in the presented product range. The present publication does not constitute an offer within the meaning of the Civil Code. The real products can differ from the example photographs and drawings in the publication. GTV Poland reserves the right to make changes and printing errors.

Данный каталог был создан компанией GTV Poland. В соответствии с действующим законодательством и требованиями рынка, компания GTV Poland оставляет за собой право вносить изменения в ассортимент предлагаемого товара. Данная публикация носит информационно-ознакомительный характер и не является коммерческим предложением в понимании права. Компания не несет ответственности за возможные цветовые расхождения, опечатки и неточности.

Dieser Produktkatalog wurde von GTV Poland vorbereitet. Wegen der ständigen Entwicklung unseres Sortiments zum Zwecke seiner Anpassung an die Markt- und Rechtsanforderungen behält GTV Poland sich das Recht vor, das im Katalog dargestellte Sortiment zu ändern. Der Katalog stellt kein Angebot im Sinne des polnischen Zivilgesetzbuches dar. Die tatsächlichen Produkte können von den im Katalog enthaltenen Fotos und Zeichnungen abweichen. GTV Poland behält sich das Recht auf Änderungen und Druckfehler vor.

Jelen kiadványt készítette a GTV Poland, kínálatának folyamatos tökéletesítésével, a piaci és jogi előírásokkal megegyezően. A GTV Poland fenntartja magának a jogot a bemutatott termékskálával kapcsolatos változtatások bevezetésére. A bemutatott ajánlat a polgári törvénykönyv értelmében nem tekinthető ajánlatnak. A valós termékek különbözhetnek a kiadványban bemutatott fényképektől és ábráktól. A kiadványban szereplő minden adat a kiadvány nyomdába kerülésének napján, azaz 2016. 02. 18-án volt érvényes. A GTV poland nem vállal felelősséget a kiadványban szereplő termékek rendelkezésre állásával kapcsolatban. A GTV poland nem vállal felelősséget a közvetett, közvetlen, véletlen vagy bármilyen egyéb kárért (ezen belül, de nem kizárólag, az elveszített haszonért, az elvesztett jövedelemért vagy hasonló gazdasági veszteségért), amely a jelen kiadványban közzétett adatok felhasználása révén következett be. A gtv poland fenntartja a változtatások és nyomdahibák jogát.

GTV

ul. Przejazdowa 21
05-800 Pruszków
Poland

 + 48 22 44 47 595

 + 48 22 44 47 527

 + 48 22 44 47 324

 + 48 22 44 47 580

 + 48 22 44 47 569

 + 420 591 160 091

 ООО 140073, РФ, «ГТВ РУС»
Московская область,
Люберецкий район, пос.Томилино,
Микрорайон Птицефабрика, Литер 7А
+ 7 495 640 15 88

 GTV Croatia d.o.o
Kovinska 4a, 10000 Zagreb
Hrvatska
+ 385 1 798 8089

 GTV Czech Distribution s.r.o.
СТPark Ostrava, Na Rovince 879
720 00 Ostrava Hrabová
Česká republika
+420 591 160 091

 GTV España Herrajes E Iluminación, S.L.
Avenida Aragón 30 8
46021 Valencia
España
+34 960 468 666

fax: +48 22 444 75 01
e-mail: oswietlenie@gtv.com.pl
www.gtv.com.pl

Follow us on:

