

2017
PL ENG

Kanlux

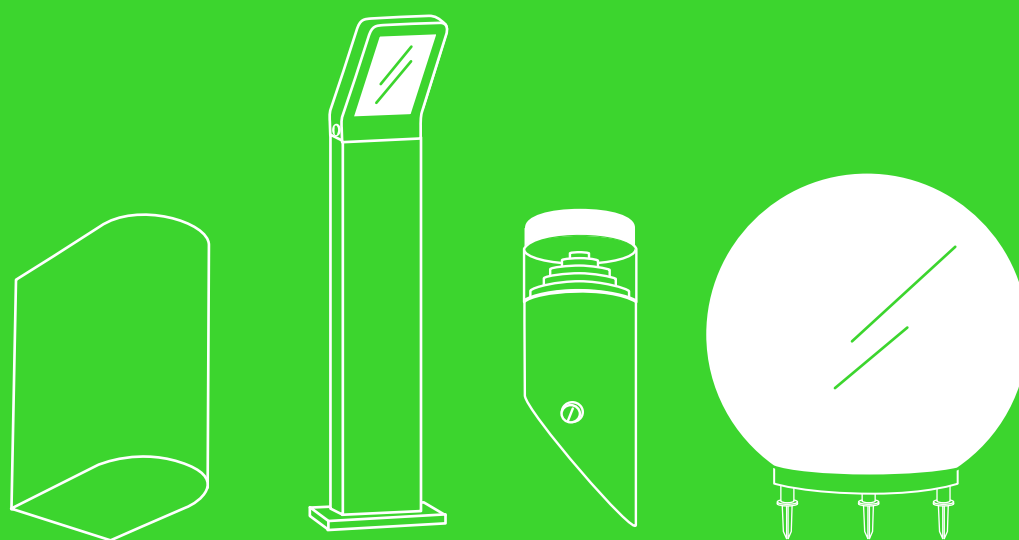

W W W . K A N L U X . C O M

**GARDEN
LIGHTS**

OPRAWY OGRODOWE

A perfect garden meets the style and needs of its owners, being the place to relax, socialize and do everyday activities. Therefore, it is extremely important that the garden is decorated and pleasing. In the evenings, garden lighting is absolutely vital. Originally arranged light emphasizes details and brings out the elements on which we desire to be highlighted, as well as illuminating dark places. We are proud to present you this year's collection of KANLUX garden lighting. Thanks to a wide range of products, materials, and the ability to use different types of light sources, everyone will be able to choose a fixture or the line of fixtures that will perfectly illuminate any garden, regardless its size or character.

Idealny ogród dopasowany jest do stylu i potrzeb jego właścicieli, pełni funkcję wypoczynkową, towarzyską i jednocześnie użytkową. Dlatego tak ważny jest komfort i wystrój ogrodu. Wieczorami bardzo ważne jest oświetlenie ogrodu. Ciekawie zaaranżowane światło pozwoli nam podkreślić detale, wydobyć elementy na które chcemy zwrócić uwagę a także doświetlić miejsca w których potrzebujemy światła po zmroku. Przedstawiamy tegoroczną kolekcję oświetlenia ogrodowego KANLUX - szeroki wybór modeli, materiałów, z których są wykonane, a także możliwość wykorzystania w nich różnych rodzajów źródeł światła pozwoli każdemu na dobranie takiej oprawy, lub całej ich serii, które idealnie oświetlą każdy ogród, bez względu na jego wielkość czy charakter.

SEVIA LED

2-3



LUGEA

16-17



LAVIA LED

4-5



DARSA

18-19



IMRA LED

6-7



ASPA

20-21



AGARA LED

8-9



IDAVA

22-23



RILA

10-11



STONO

24-25



SORTA

12-13



SOPER/SOBI

26-27



NOVIA

14-15



SEVIA LED

EN Untypical, black lamps made of aluminum alloy and glass, with neutral light color provided by integrated LED SMD. SEVIA means innovative design and additional functions – to select from, one out of every two wall lamps is equipped with a motion sensor. The poles are 50 or 80 cm high, additionally SEVIA LED 50-SO is equipped with a power supply socket, which can be helpful in a situation when an additional power supply source is needed in the garden.

PL Nietypowe, czarne lampy zbudowane ze stopu aluminium i szkła, z białą neutralną barwą światła, którą dają wbudowane diody LED SMD. SEVIA to nowatorski design i dodatkowe funkcje – do wyboru, wśród dwóch kinkietów mamy jeden wyposażony w czujnik ruchu. Jeżeli chodzi o słupki to mają one wysokość 50 lub 80 centymetrów, dodatkowo SEVIA LED 50-SO wyposażona jest w gniazdo wtykowe, co może nam pomóc w sytuacji, gdy potrzebujemy dodatkowego źródła zasilania w ogrodzie.





SEVIA LED 26

Index: 23550
EAN: 5905339235503
9W IP54



SEVIA LED 26-SE

Index: 23551
EAN: 5905339235510
9,5W IP44



SEVIA LED 50

Index: 23552
EAN: 5905339235527
9W IP54



SEVIA LED 50-SO

Index: 23553
EAN: 5905339235534
9W IP44



SEVIA LED 80

Index: 23554
EAN: 5905339235541
9W IP54



220-240V~
50/60Hz

[lm]
600

LED SMD



[mm²]
3 x (0,5-2,5)

≥15 000

[h]
30 000

Tc [K]
EUPSE
≤ 6x MacAdam
4000

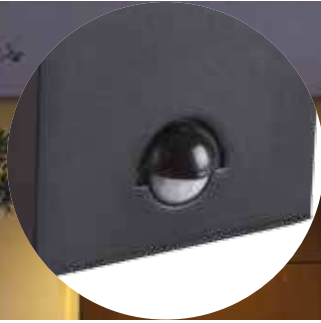

Neutral white High luminous flux

Neutralna barwa światła
Wysoki strumień świetlny

SEVIA LED 26-SE equipped with a motion sensor

SEVIA LED 26-SE wyposażona
w czujnik ruchu

SEVIA LED 50-SO equipped with IP44/250V/16A socket

SEVIA LED 50-SO wyposażona
w gniazdo wtykowe
IP44/250V/16A

Modern design Casing: aluminum and glass

Nowoczesny styl
Obudowa: stop
aluminium i szkło

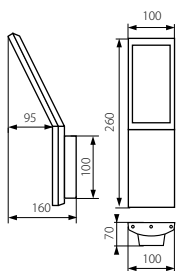

SEVIA LED 26

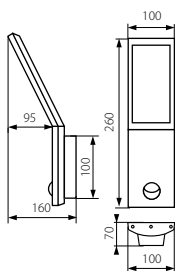

SEVIA LED 26-SE

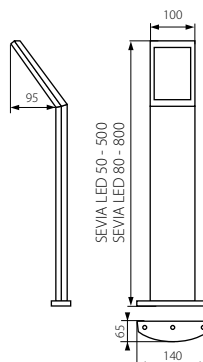

SEVIA LED 50 - 500
SEVIA LED 80 - 800

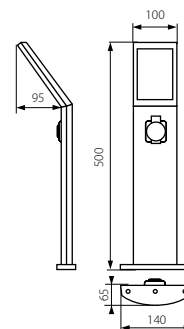

SEVIA LED 50-SO

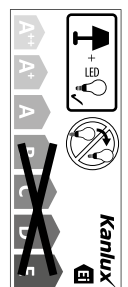

LAVIA LED

EN This is a collection of garden fittings for people who are determined and value extraordinary shapes and ideas. The lamps whose shape resembles a magnifying glass comprise two poles, 50 or 80 cm high and a wall lamp. Additionally, LAVIA LED 50-SO is equipped with a power supply socket, which can make our garden work or recreation much easier in situations when we need a power supply source. The lamps are made of aluminum alloy and include an integrated LED COB light source.

PL To kolekcja opraw ogrodowych dla ludzi zdecydowanych i ceniących nietuzinkowe kształty oraz pomysły. Lampy te, przypominające swoim kształtem lupę, to dwa słupki o wysokości 50 lub 80 centymetrów i oprawa elewacyjna. Dodatkowo LAVIA LED 50-SO wyposażona jest w gniazdo wtykowe, co może nam znacznie ułatwić pracę lub rekreację w ogrodzie w sytuacji gdy potrzebujemy źródła zasilania. Lampy wykonane są ze stopu aluminium, posiadają wbudowane źródło światła LED COB.





LAVIA LED 18
Index: 23560
EAN: 5905339235602



LAVIA LED 50
Index: 23561
EAN: 5905339235619



LAVIA LED 50-SO
Index: 23563
EAN: 5905339235633



LAVIA LED 80
Index: 23562
EAN: 5905339235626



220-240V~
50/60Hz

[lm]
130

LED COB



[W]
4

[mm²]
3 x (0,5-2,5)

≥ 15 000

[h]
30 000

Tc [K]
EIPSE
≤ 6x MacAdam
4000

IP44



CE

ERC



Modern design
 Nowoczesny styl



Neutral white
 Neutralna barwa światła



LAVIA LED 50-SO
equipped with socket
IP44/250V/16A
 LAVIA LED 50-SO
 wyposażona w gniazdo
 wtykowe IP44/250V/16A

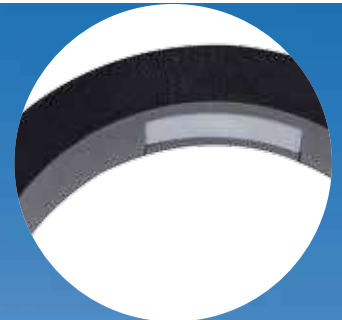

Casing: aluminum alloy
and plastic
 Obudowa: stop
 aluminium i tworzywo
 sztuczne

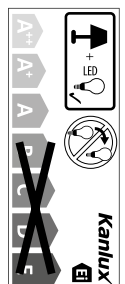
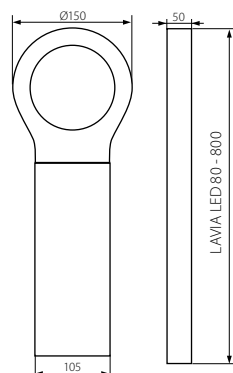
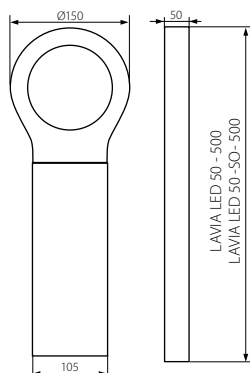
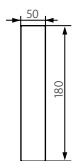
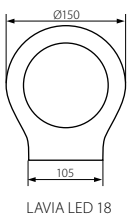

IMRA LED

EN The IMRA lamp family consists of three fittings - two poles, 45 or 80 cm high, and a wall lamp. A broad, flattened shade resembles a flying saucer that can shine each time with its integrated LED light source. The warm light color and an exceptional reflector distinguish this group of lamps. Stainless steel and the highest quality plastic are the materials that these lamps have been made of.

PL Rodzina lamp IMRA to trzy oprawy – dwa słupki o wysokości 45 lub 80 centymetrów oraz kinkiet elewacyjny. Szeroki, spłaszczony klosz przywodzi na myśl latający talerz, który każdego wieczoru może rozbłysnąć wbudowanym źródłem światła LED. Ciepła barwa światła i wyjątkowy odbłyśnik wyróżniają tę grupę lamp. Stal nierdzewna i najwyższej jakości tworzywo sztuczne to materiały, z których zostały one wykonane.





IMRA LED 16L UP

Index: 23540
EAN: 5905339235404



IMRA LED 45

Index: 23541
EAN: 5905339235411



IMRA LED 80

Index: 23542
EAN: 5905339235428



- 220-240V~
50/60Hz
- [lm]
350
- LED SMD
-
- [W]
5
- [mm²]
3 x (0,5-2,5)
- [h]
≥15 000
- [h]
20 000
- Tc [K]
ECLIPSE
≤ 6x MacAdam
3000
- IP44**
-
-
- CE**
- EAC**



Modern design
Nowoczesny styl

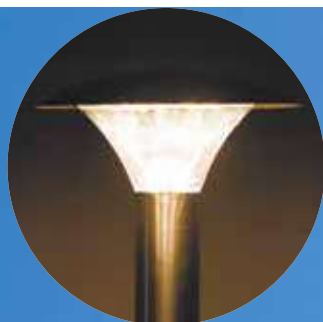

Warm white
Ciepła barwa światła

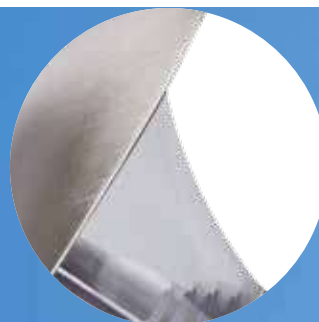

Casing: stainless steel and plastic
Obudowa: stal nierdzewna i tworzywo sztuczne



Unique shape of lampshade
Unikalny kształt klosza

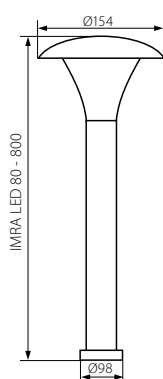
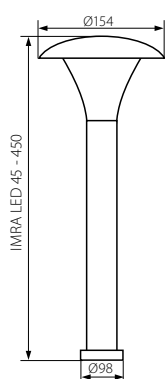
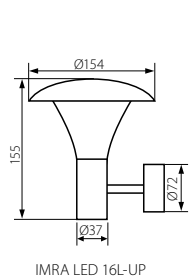

AGARA LED

EN Classic garden fittings made of stainless steel with an integrated LED SMD light. The characteristic reflector and shade made of plastic diffuse light in such a way as to bring out the facade of a building or dark corners of a garden. Cool light temperature and low energy consumption are additional characteristics of these fittings. Two poles, 50 or 80 cm high, and two wall lamps (straight and slanted) make up the complete family of AGARA fittings.

PL Klasyczne oprawy ogrodowe wykonane ze stali nierdzewnej z wbudowanym źródłem światła LED SMD. Charakterystyczny odbłyśnik i klosz z tworzywa sztucznego rozprasza światło w taki sposób, aby jak najlepiej wydobyć detale elewacji budynku czy zakamarków ogrodu. Zimna barwa światła i niskie zużycie energii to dodatkowe wyróżniki tych opraw. Dwa słupki o wysokości 50 lub 80 centymetrów i dwa kinkiety (prosty oraz skośny) to kompletna rodzina opraw AGARA.





**AGARA LED
EL-14L-UP**

Index: 18600
EAN: 5905339186003



**AGARA LED
EL-19I-UP**

Index: 18601
EAN: 5905339186010



**AGARA LED
EL-50**

Index: 18602
EAN: 5905339186027



**AGARA LED
EL-80**

Index: 18604
EAN: 5905339186041



220-240V~
50/60Hz

[lm]
110

LED SMD



[W]
3

[mm²]
3 x (1-2,5)

≥15 000

[h]
20 000

Tc [K]
EUPSE
≤ 6x MacAdam
6500

IP44



CE

ERC



Ring reflector
Pierścieniowy odbłyśnik



Cold white
Zimna barwa światła



**Casing: stainless steel,
diffuser: plastic**
Obudowa: stal nierdzewna,
klosz: tworzywo sztuczne



Modern design
Nowoczesny styl

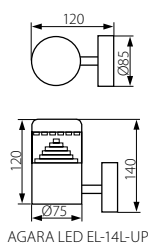

AGARA LED EL-14L-UP

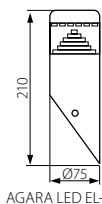

AGARA LED EL-19I-UP

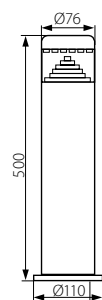

AGARA LED EL-50



AGARA LED EL-80

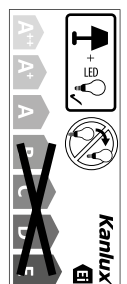

RILA

EN RILA is the most classic garden fitting family with a replaceable light source with an E27 cap, offered by KANLUX. These fittings are perfectly suited for decorative illumination of all kinds of gardens, parks or gazebos, and thanks to the use of high quality materials - aluminum alloy - they can serve their user for many years. Apart from two poles of different height (30 or 100 cm) and two kinds of wall lamps (downward or upward), the offer also includes a suspended lamp.

PL RILA to najbardziej klasyczna rodzina opraw ogrodowych z wymiennym źródłem światła o trzonku E27 w ofercie KANLUX. Doskonale nadają się do oświetlenia dekoracyjnego wszelkiego rodzaju ogrodów, parków, czy altan, a dzięki zastosowaniu wysokiej jakości materiałów - w postaci stopu aluminium - mogą służyć użytkownikowi przez wiele lat. Oprócz dwóch słupków różniących się wysokością (30 lub 100 centymetrów) oraz dwóch rodzajów kinkietów (skierowany w górę lub w dół) w ofercie znajduje się również lampa wisząca.





RILA 30

Index: 23583
EAN: 5905339235831



RILA 23L-UP

Index: 23580
EAN: 5905339235800



RILA 100

Index: 23584
EAN: 5905339235848



RILA 23L-DOWN

Index: 23581
EAN: 5905339235817



RILA 81-PEND

Index: 23582
EAN: 5905339235824



220-240V~
50/60Hz



E27

IP44



max. 60



3 x (0,5-2,5)



Classic style
Styl klasyczny



Replaceable light source
Wymienne źródło światła



Casing: aluminum alloy and plastic
Obudowa:
stop aluminium
i tworzywo sztuczne



Frost lampshade
Szroniony klosz

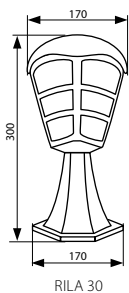

RILA 30

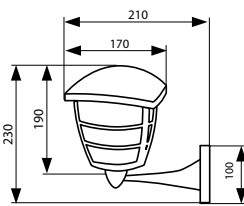

RILA 23L-UP

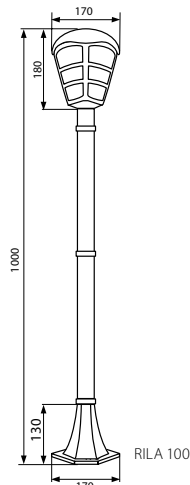

RILA 100

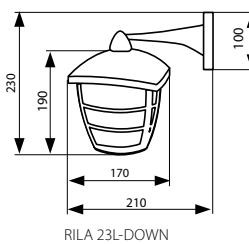

RILA 23L-DOWN

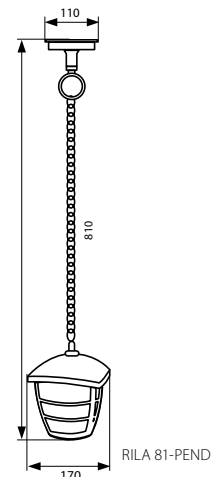

RILA 81-PEND

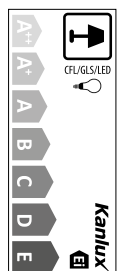

SORTA

EN SORTA is the family of five fixtures adapted to different needs. Three different wall fixtures, including one with a motion sensor (SORTA 16L-UP-SE) and two standing lamps of different heights (50 cm and 80 cm). They are equipped with a replaceable light source, which allows to choose the colour and power of the light for your individual needs. What is more, the internal opal lampshade evenly diffuses the light. The fixtures are made of glass and aluminium, so they will match almost every setting.

PL SORTA to rodzina pięciu opraw, które dostosowane są do różnych potrzeb. Trzy różne oprawy ściienne, w tym jeden z czujnikiem ruchu (SORTA 16L-UP-SE) i dwa słupki o różnych wysokościach. Oprawy te mają wymienne źródło światła co pozwala na dostosowanie barwy i mocy światła do indywidualnych potrzeb. Ponadto wewnętrzny klosz opalizowany równomiernie rozprasza światło. Oprawy zbudowane są ze szkła i aluminium, a ich czarno-biała kolorystyka wpisze się niemal w każdą scenę.





SORTA 16L-UP
Index: 25680
EAN: 5905339256805



SORTA 16L-UP-SE
Index: 25681
EAN: 5905339256812



SORTA 30I-UP
Index: 25682
EAN: 5905339256829



SORTA 50
Index: 25683
EAN: 5905339256836



SORTA 80
Index: 25684
EAN: 5905339256843



220-240V~
50/60Hz



E27



x= max.
55mm

IP44



max. 20



0,5-2,5
mm²



Replaceable light source
Wymienne źródło światła

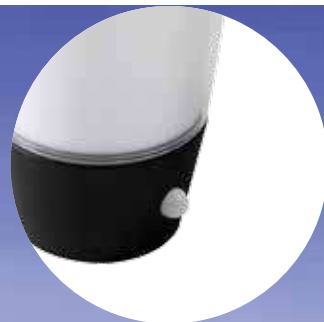

SORTA 16L-UP-SE equipped with a motion sensor
SORTA 16L-UP-SE
wyposażona w czujnik ruchu



Internal opal diffuser
Wewnętrzny klosz opalizowany



Casing: aluminum and plastic
Obudowa: aluminium i tworzywo sztuczne

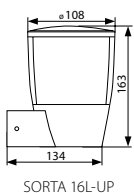

SORTA 16L-UP

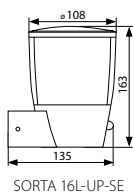

SORTA 16L-UP-SE

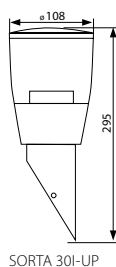

SORTA 30I-UP

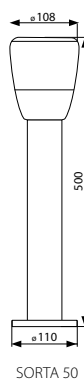

SORTA 50

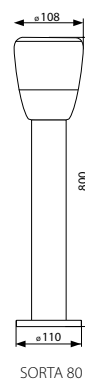

SORTA 80

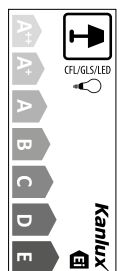

NOVIA

EN A spectacular, well chosen garden lighting makes your garden a place where you can relax and have a nice time, especially after dark, when an illuminated garden gets a new lease of life. NOVIA fixtures will be appreciated by those looking for both general and decorative lighting for their garden. The NOVIA family comprises of four products, the first two of which are sconces. The light in the first sconce is directed downwards, whereas in the second one the light is directed both upwards and downwards. There are also two standing lamps: one single and one double-headed both with their light directed downwards. NOVIA fixtures have a characteristic "window" in their front part, which becomes an additional light feature when the lamps are turned on. They are of a unique design, made with precision from the materials of the highest quality.

PL Efektowne, dobrze dobrane oświetlenie w ogrodzie sprawia, że staje się on miejscem wypoczynku i mile spędzonych chwil, zwłaszcza po zmroku, kiedy to oświetlony ogród otrzymuje drugie życie. NOVIA to oprawy, które znajdą swoich zwolenników wśród osób szukających oświetlenia zarówno ogólnego jak i akcentowego w swoim ogrodzie. Rodzinę NOVIA tworzą cztery produkty: dwa kinkiety; w jednym światło skierowane jest w dół, w drugim kierunku świecenia to góra i dół, i dwa słupki: pojedynczy oraz podwójny – oba ze światłem skierowanym w dół. Oprawy NOVIA posiadają charakterystyczne „okienko” w części frontowej, które po zaświeceniu staje się dodatkowym akcentem świetlnym. Są to oprawy o unikalnym designie oraz precyzyjnym wykonaniu z najwyższej jakości materiałów.





NOVIA EL 120 D

Index: 25662
EAN: 5905339256621
max. 20W

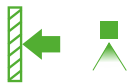

NOVIA EL 220 U/D

Index: 25663
EAN: 5905339256638
2 x max. 20W



NOVIA 120 D

Index: 25661
EAN: 5905339256614
max. 20W



NOVIA 220 D

Index: 25660
EAN: 5905339256607
2 x max. 20W



220-240V~
50/60Hz

GU10

JDR

IP44

[mm²]
0,5 x 2,5

CE

EAC



Replaceable light source
Wymienne źródło światła



Modern design
Nowoczesny styl



Casing: aluminum and glass
Obudowa: aluminium i szkło



Front light accent
Akcent świetlny
na froncie oprawy

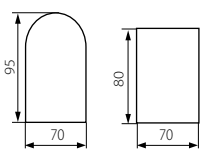

NOVIA EL 120 D

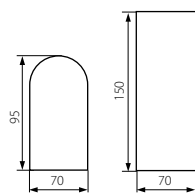

NOVIA EL 220 U/D

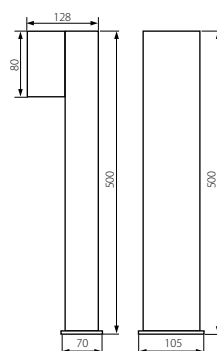

NOVIA 120 D

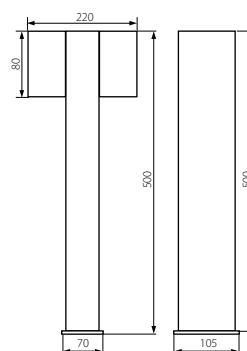

NOVIA 220 D

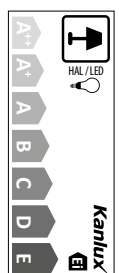

LUGEA

EN The innovative and at the same time simple and ascetic design of LUGEA lamp fittings will ideally fit almost every garden. Stainless steel and the highest quality plastic that the shade of the fitting is made of will highlight the qualities of every garden. The collection consists of two poles, 50 and 80 cm high, and a wall lamp that can also be fitted with a motion sensor. All fittings can be equipped with E27 cap light sources.

PL Nowatorski, a zarazem prosty, wręcz ascetyczny design opraw LUGEA doskonale dopasuje się praktycznie do każdego ogrodu. Stal nierdzewna oraz tworzywo sztuczne najwyższej jakości, z którego wykonano klosz opraw, podkreślą walory każdego ogrodu. W skład tej kolekcji wchodzi dwa słupki o wysokości 50 lub 80 cm, oraz kinkiet, który możemy wybrać również w wersji z czujnikiem ruchu. Wszystkie oprawy możemy wyposażyć w źródła światła z trzonkiem E27.





LUGEA 28L-UP

Index: 23530
EAN: 5905339235305



LUGEA 31L-UP-SE

Index: 23531
EAN: 5905339235312



LUGEA 50

Index: 23532
EAN: 5905339235329



LUGEA 80

Index: 23533
EAN: 5905339235336



220-240V~
50/60Hz



E27

IP44



max. 60



3 x (0,5-2,5)



CE

ERC



Replaceable light source
Wymienne źródło światła



Casing: stainless steel and plastic
Obudowa: stal nierdzewna i tworzywo sztuczne



LUGEA 31L-UP-SE - movement and twilight sensor
LUGEA 31L-UP-SE - czujnik ruchu i zmierzchu



Unique shape of lampshade
Unikalny kształt klosza

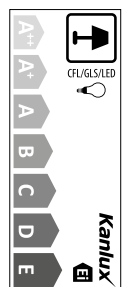
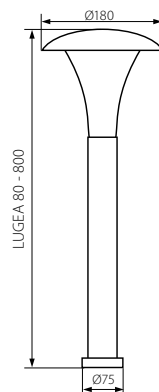
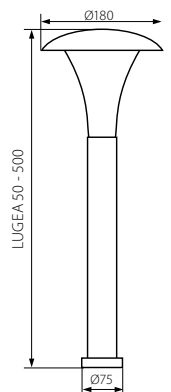
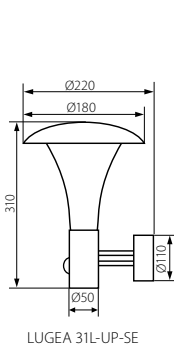
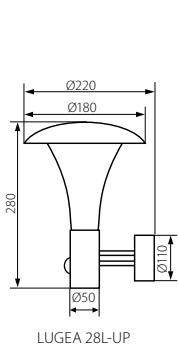

DARSA

EN A timeless and universal collection of garden fittings of stainless steel and tempered glass. GU10 light sources can be selected individually for these fittings. There are four fittings to choose from in the DARSA series – two 50 cm poles with one or two light sources, and a wall lamp emitting light downwards or both upwards and downwards.

PL Ponadczasowa i uniwersalna kolekcja opraw ogrodowych ze stali nierdzewnej i hartowanego szkła. Źródła światła z trzonkiem GU10 do tych opraw możemy dobrać indywidualnie. Do wyboru mamy cztery oprawy z serii DARSA – dwa słupki o wysokości 50 centymetrów z jednym lub dwoma źródłami światła, oraz kinkiet który świeci w dół lub w górę i w dół jednocześnie.





**DARSA
EL-135L-UP**

Index: 19120
EAN: 5905339191205
max. 35W

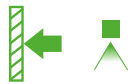

**DARSA
EL-235T-UP**

Index: 19121
EAN: 5905339191212
2 x max. 35W

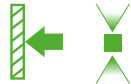

**DARSA
EL-135**

Index: 19122
EAN: 5905339191229
max. 35W



**DARSA
EL-235A**

Index: 19123
EAN: 5905339191236
2 x max. 35W



220-240V~
50/60Hz



IP44

(mm²)
3 x (1-2,5)



CE

ErC



Replaceable light source
Wymienne źródło światła



**Casing: stainless steel
and glass**
Obudowa: stal nierdzewna
i szkło



Hard glass
Hartowane szkło



Modern design
Nowoczesny styl

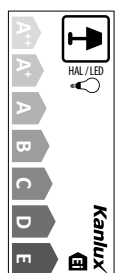
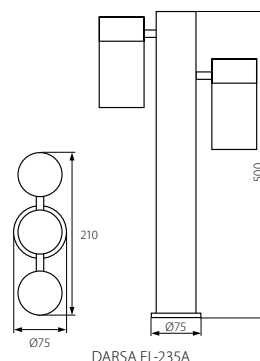
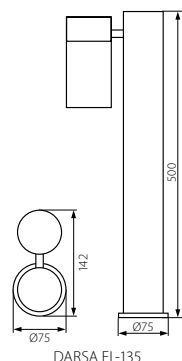
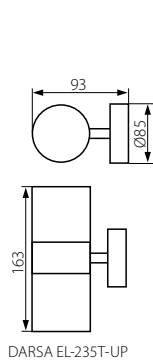
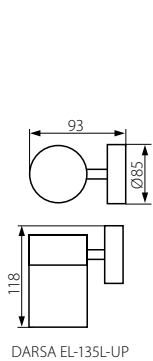

ASPA

EN ASPA is a series of fittings with a minimalistic and at the same time modern look. The fittings are made of stainless steel, and their aesthetics make each garden, driveway or a green area gain exceptional character. Light sources for these fittings can be selected individually, depending on the needs or the intended application of the illumination (E27 cap).

PL ASPA to seria opraw o minimalistycznym, a zarazem nowoczesnym wyglądzie. Oprawy wykonane są ze stali nierdzewnej, a ich estetyka sprawia, że każdy ogród, podjazd czy teren zielony uzyskuje wyjątkowy charakter. Do opraw tych źródło światła dobierzemy indywidualnie w zależności od potrzeb czy przeznaczenia oświetlenia (trzonek E27).





ASPAS 331-UP
Index: 23600
EAN: 5905339236005



ASPAS 20L-UP
Index: 23601
EAN: 5905339236012



ASPAS 50
Index: 23602
EAN: 5905339236029



ASPAS 80
Index: 23603
EAN: 5905339236036



220-240V~
50/60Hz

$\varnothing x$
x= max.
48,5mm

E27

IP44

max. 13

[mm²]
3 x (0,5-2,5)



CE

ERC



Replaceable light source
 Wymienne źródło światła



Casing: stainless steel and plastic
 Obudowa: stal nierdzewna i tworzywo sztuczne



Milky lampshade
 Mleczny klosz



Minimalistic design
 Minimalistyczny design

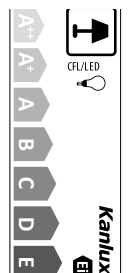
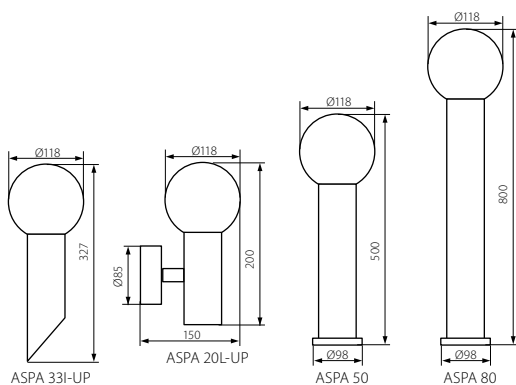

IDAVA

EN A very simple family of ground fittings, IDAVA is a discrete way to create light spaces in the garden. The fixtures are characterized by a high degree of protection; moreover, their design and material additionally protects the source of light from external factors. Thanks to the E27 base, the users of products from the IDAVA line can choose the colour and power of the light according to their own needs and preferences.

PL Bardzo prosta w swej formie rodzina opraw dogruntowych IDAVA to dyskretny sposób na stworzenie jasnych przestrzeni w ogrodzie. Oprawy te cechuje wysoki stopień szczelności, a ich konstrukcja oraz tworzywo sztuczne, z którego wykonana jest lampa dodatkowo chroni źródło światła (o trzonku E27, które możemy dobrać indywidualnie) przed wpływem czynników zewnętrznych. Trzonek E27 daje użytkownikowi serii IDAVA możliwość kształtowania według własnych upodobań zarówno barwy jak i mocy światła zastosowawszy odpowiednie źródło światła.





IDAVA 25
Index: 23510
EAN: 5905339235107
max. 25W



IDAVA 35
Index: 23511
EAN: 5905339235114
max. 40W



IDAVA 47
Index: 23512
EAN: 5905339235121
max. 40W



220-240V~
50/60Hz



IP44



CE

EAC



Replaceable light source
 Wymienne źródło światła



Includes 3m cord
 W komplecie przewód 3m



Modern design
 Nowoczesny styl



Milky lampshade
 Mleczny klosz

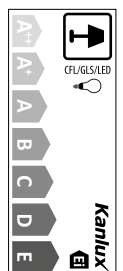
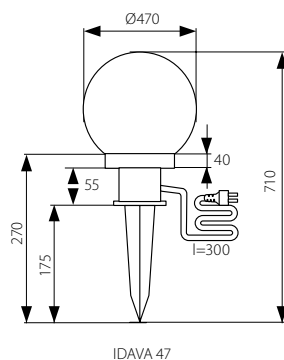
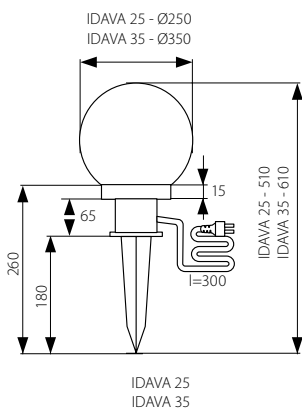

STONO

EN The new family of STONO garden fixtures is characterised by its spherical shape and imitation granite stone. It will perfectly integrate with not only rockeries and shrubs, but also with the landscape of a winter garden. Among the STONO fixtures you will find four balls diameters: 20cm, 30cm, 40cm and 50cm. Each of them is equipped with a base that allows you to embed it in the ground. Thanks to the flat bottom of STONO, the fixtures can be placed on the lawn, terrace, balcony or paving stones. STONO fixtures work with all sources of light with the E27 base; therefore, you can choose the desired power and colour of light yourself.

PL Nowa rodzina opraw ogrodowych STONO to kulisty kształt i imitacja wyglądu kamienia granitowego, która idealnie wkomponuje się w otoczenie skalniaków, krzewów jak również wtopi się w pejzaż ogrodu zimowego. Wśród opraw STONO znajdziemy cztery średnice kul: 20cm, 30cm, 40cm oraz 50cm. Każda z nich wyposażona jest w podstawę pozwalającą osadzić oprawę w gruncie. Płaski dół STONO daje możliwość umieszczenia opraw zarówno na trawniku jak i na tarasie, balkonie czy powierzchni wyłożonej kostką brukową. Oprawy STONO współpracują ze wszystkimi źródłami światła o trzonku E27, więc sami możemy dobrać moc i barwę światła na jakiej nam zależy.



STONO 20

Index: 24650
EAN: 5905339246509



STONO 30

Index: 24651
EAN: 5905339246516



STONO 40

Index: 24652
EAN: 5905339246523



STONO 50

Index: 24653
EAN: 5905339246530



220-240V~
50/60Hz



IP65

2 x 1mm²
300 cm



CE

ERC



Replaceable light source
Wymienne źródło światła



Spikes for embedding the fixture in the ground
Szpikulce do osadzenia oprawy w gruncie



Includes 3m cord
W komplecie przewód 3m



Granite imitation
Imitacja granitu

STONO 20 = Ø 200
STONO 30 = Ø 300
STONO 40 = Ø 400
STONO 50 = Ø 500

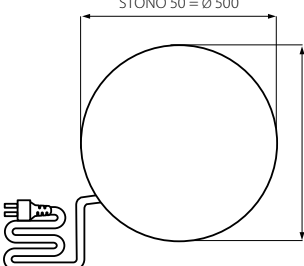

STONO 20 = Ø 190
STONO 30 = Ø 280
STONO 40 = Ø 380
STONO 50 = Ø 480

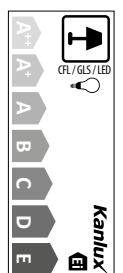
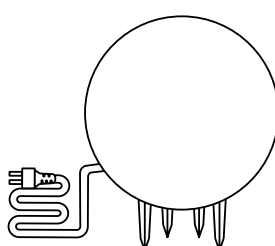

SOPER/SOBI

EN The new SOPER and SOBI lamps feature stainless steel, a PC material and an integrated solar panel. The main advantage of the lamps is their modern design and built-in batteries, which gives you the convenience of being independent from electrical installations. SOPER sconces are an on-wall lighting with a motion sensor (SOPER PV-SE) and without it (SOPER PV), whereas SOBI line comprises of a sconce and a standing lamp. The fixtures have an in-built source of light with a cold temperature colour. All fixtures have a modern design.

PL Nowe lampy SOPER i SOBI to stal nierdzewna, tworzywo PC i zintegrowany panel solarny. Nowoczesny styl lamp i wygoda powodowana wbudowanymi akumulatorami i tym samym niezależność od instalacji elektrycznej, to ich niewątpliwe atuty. Kinkiety SOPER to oświetlenie naścienne w wersji z czujnikiem ruchu (SOPER PV-SE) oraz bez (SOPER PV), natomiast seria SOBI to kinkiety i słupki. Oprawy te mają wbudowane źródło światła w zimnej barwie. Wszystkie te oprawy cechuje nowoczesny wygląd.





SOPER PV

Index: 25750
EAN: 5905339257505



SOPER PV-SE

Index: 25751
EAN: 5905339257512



SOBI PV 21

Index: 25760
EAN: 5905339257604



SOBI PV 50

Index: 25661
EAN: 5905339257611



SOPER: 3.2V DC
LiFePO4 14500
SOBI: 2 x AA 1,2V DC

SOPER: 10
SOBI: 15

SOPER: 0,16
SOBI: 0,15

LED SMD



≥ 15 000

15 000

Tc [K]
EUPSE
≤ 6x MacAdam
6500











Integrated solar panel
Zintegrowany panel solarny



Cold white
Zimna barwa światła



SOPER PV-SE equipped with motion sensor
SOPER PV-SE wyposażona w czujnik ruchu



Modern design
Nowoczesny styl

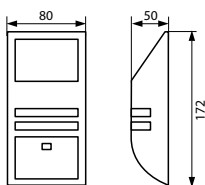

SOPER PV

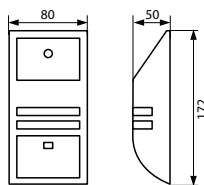

SOPER PV-SE

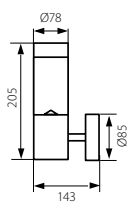

SOBI PV 21

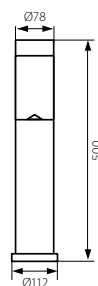

SOBI PV 50

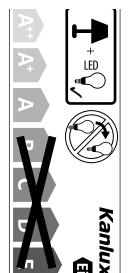

NOTES / NOTATKI

This publication has been prepared by Kanlux SA Through the continuous improvement of its offer and adaptation of it to market and legal requirements, Kanlux SA reserves the right to make changes in its product mix. This publication is not an offer within the meaning of the Civil Code. Actual products may differ from illustrative photos and drawings included in the publication. All of the data contained in the publication is in force on the date of printing i.e. 22 march 2017. Kanlux SA shall not be liable for the non-availability of products listed in this publication. Kanlux SA also shall not be liable for any direct, indirect, accidental or any other damages (including, but not limited to, lost profits, lost revenues or similar economic losses) arising out of the use of information contained in this publication. Kanlux SA reserves the right for errors and changes in print.

Niniejsza publikacja została przygotowana przez Kanlux SA. Poprzez ciągle udoskonalanie swojej oferty i dostosowanie jej do wymogów rynkowych i prawnych Kanlux SA zastrzega sobie prawo do wprowadzenia zmian w asortymencie. Prezentowana publikacja nie jest ofertą w rozumieniu Kodeksu Cywilnego. Rzeczywiste produkty mogą odbiegać od poglądowych zdjęć i rysunków zamieszczonych w publikacji. Wszystkie dane zawarte w publikacji obowiązują w dniu oddania jej do druku tj. 22 marca 2017. Kanlux SA nie ponosi odpowiedzialności za brak dostępności produktów zamieszczonych w niniejszej publikacji. Kanlux SA nie ponosi także odpowiedzialności za jakiegokolwiek bezpośrednie, pośrednie, przypadkowe lub jakiegokolwiek inne szkody (w tym również , ale nie wyłącznie, utracone zyski, utracone przychody lub podobne starty ekonomiczne) powstałe w wyniku korzystania z informacji zawartych w niniejszej publikacji. Kanlux SA zastrzega sobie prawo do błędów i zmian w druku.

